

NO.	DESCRIPTION	DATE

HCS-1085

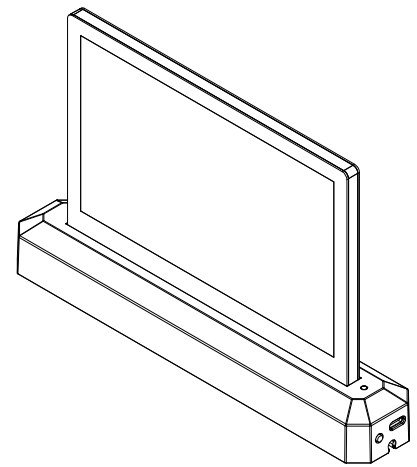

PROJECT NAME	108-108	PROJECT NO.	
DRAWING NO.		DRAWING NO.	
DATE		DATE	

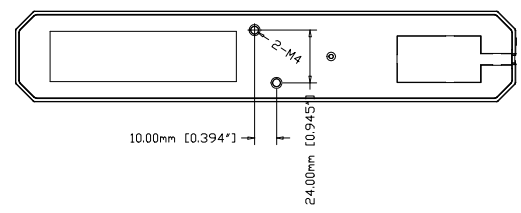
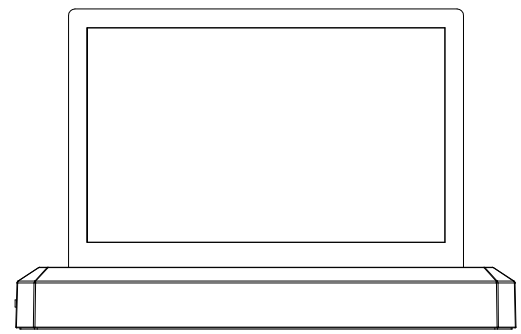
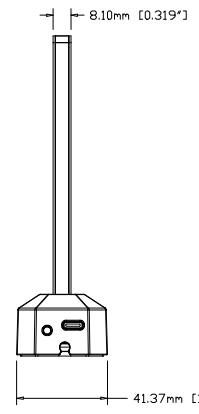
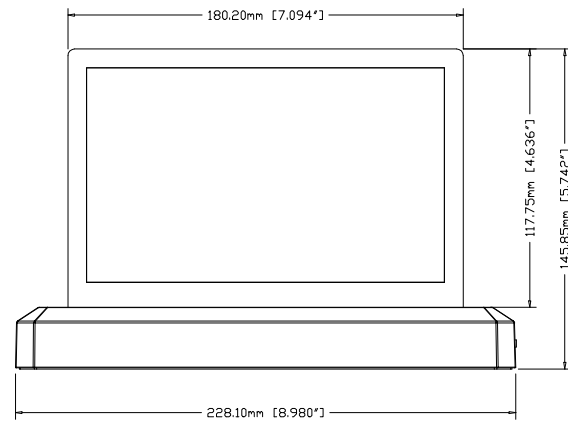
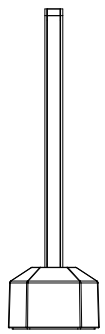
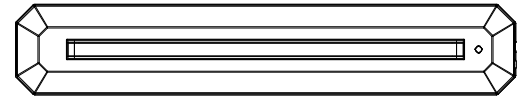