

NO.	DESCRIPTION	DATE

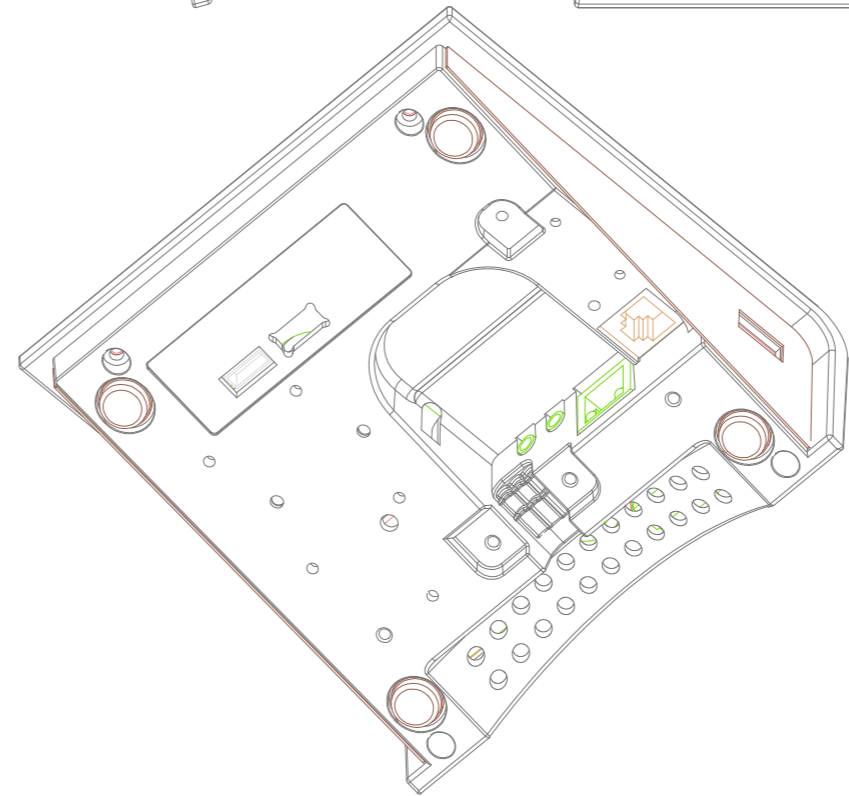
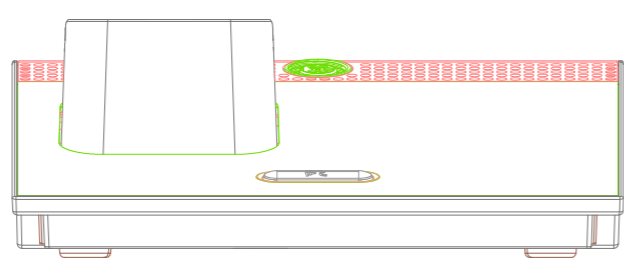
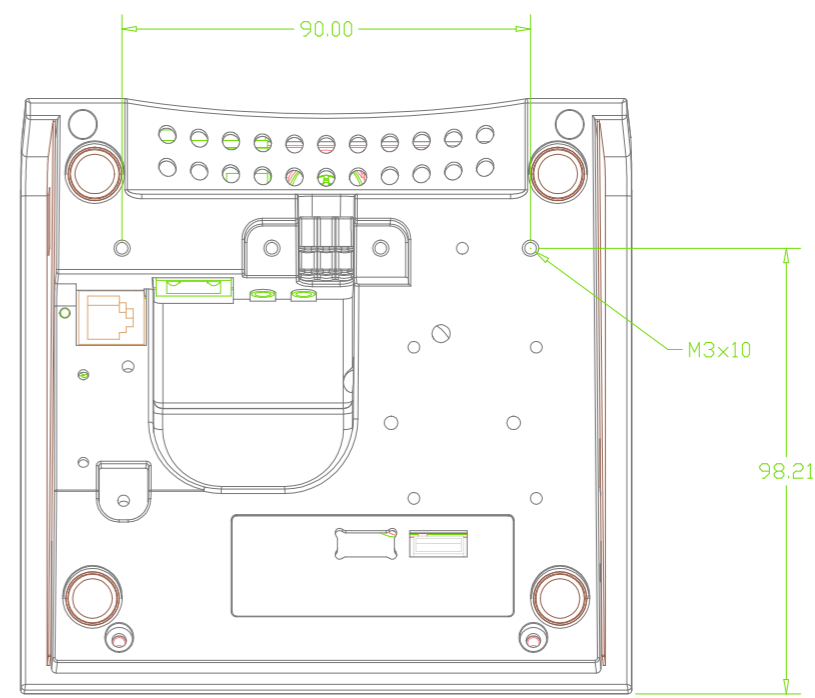
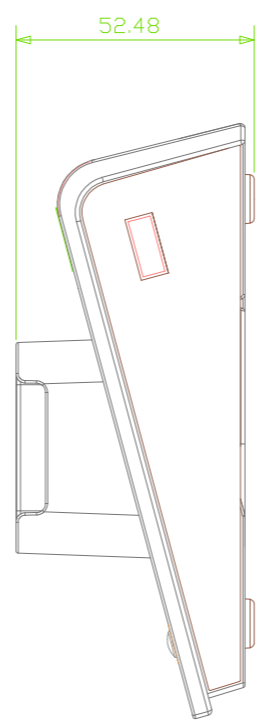
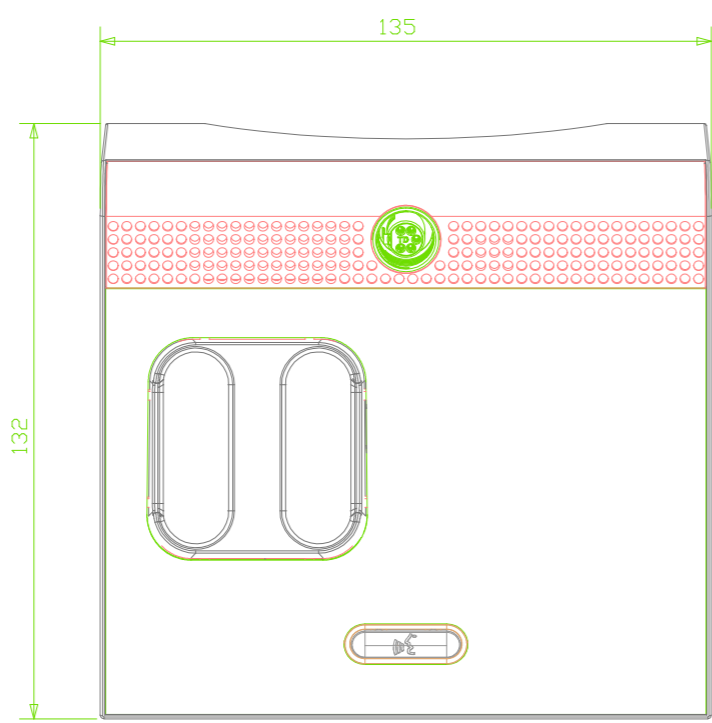
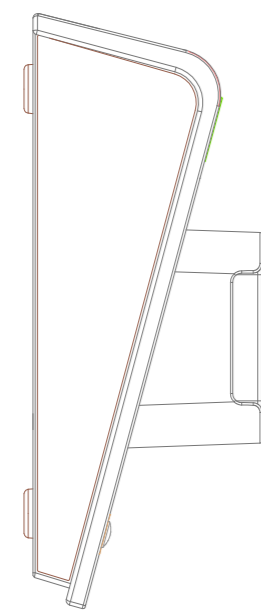
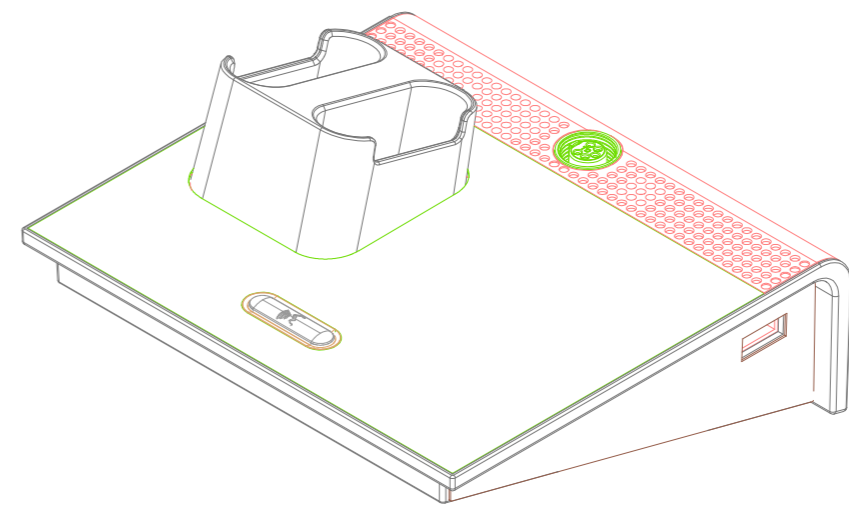
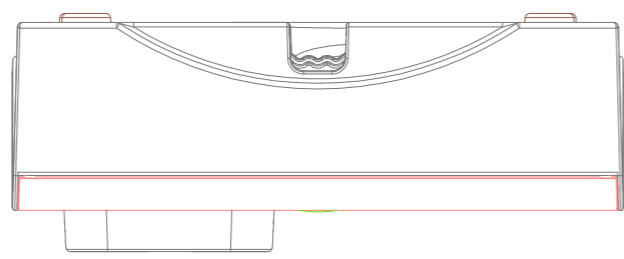

PROJECT NAME				PROJECT NO.	
DRAWING NAME				DRAWING NO.	
DESIGNED BY	DATE	SCALE	UNIT		
CHECK BY	DATE	SCALE	UNIT		
APPROVAL BY	DATE				
TAVOYEN®				TAVOYEN INDUSTRIAL CO., LTD.	