

New Premium Digital Congress System



HCS-4890N/80 Series



HCS-4860/80 Series



HCS-4838/80 Series



HCS-48U6/80 Series

HCS-4800 Series New Premium Digital Congress System		6
HCS-4890N/80 Series Congress Units		13
HCS-4890NCVSE_B/80	Fully Digital Congress System Chairman Unit (tabletop, discussion, 5 voting keys, built-in contactless IC-Card slot, 64 CHs, 4.3" touch screen, Braille, black)	13
HCS-4890NDVSE_B/80	Fully Digital Congress System Delegate Unit (tabletop, discussion, 5 voting keys, built-in contactless IC-Card slot, 64 CHs, 4.3" touch screen, Braille, black)	15
HCS-4890NCS_B/80	Fully Digital Congress System Chairman Unit (tabletop, discussion, 64 CHs, 4.3" touch screen, Braille, black)	17
HCS-4890NDS_B/80	Fully Digital Congress System Delegate Unit (tabletop, discussion, 64 CHs, 4.3" touch screen, Braille, black)	19
HCS-4890N/FM/80 Series Congress Units		21
HCS-4890NCVSE/FM_B/80	Fully Digital Congress System Chairman Unit (flush-mounting, discussion, 5 voting keys, built-in contactless IC-Card slot, 64 CHs, 4.3" touch screen, black)	21
HCS-4890NDVSE/FM_B/80	Fully Digital Congress System Delegate Unit (flush-mounting, discussion, 5 voting keys, built-in contactless IC-Card slot, 64 CHs, 4.3" touch screen, black)	23
HCS-4891/80 Series Congress Units		26
HCS-4891CVS_B/80	Fully Digital Congress System Chairman Unit (tabletop, discussion, voting, 64 CHs×2, 4.3" touch screen, black)	26
HCS-4891DVS_B/80	Fully Digital Congress System Delegate Unit (tabletop, discussion, voting, 64 CHs×2, 4.3" touch screen, black)	28
HCS-4891C_B/80	Fully Digital Congress System Chairman Unit (tabletop, discussion, 4.3" touch screen, black)	30
HCS-4891D_B/80	Fully Digital Congress System Delegate Unit (tabletop, discussion, 4.3" touch screen, black)	32
HCS-4891R/80 Series Congress Units		35
HCS-4891RCVS_S/80	Fully Digital Congress System Chairman Unit (tabletop, discussion, voting, 64 CHs×2, 4.3" touch screen, rectangular columnar metal microphone, silver microphone + black base)	35
HCS-4891RDVS_S/80	Fully Digital Congress System Delegate Unit (tabletop, discussion, voting, 64 CHs×2, 4.3" touch screen, rectangular columnar metal microphone, silver microphone + black base)	37
HCS-4891RC_S/80	Fully Digital Congress System Chairman Unit (tabletop, discussion, 4.3" touch screen, rectangular columnar metal microphone, silver microphone + black base)	39
HCS-4891RD_S/80	Fully Digital Congress System Delegate Unit (tabletop, discussion, 4.3" touch screen, rectangular columnar metal microphone, silver microphone + black base)	41
HCS-4891R/80/2M Series Congress Units		44
HCS-4891RCVS_S/80/2M	Fully Digital Congress System Chairman Unit (tabletop, discussion, voting, 64 CHs×2, 4.3" touch screen, rectangular columnar metal microphone, main microphone + backup microphone, silver microphone + black base)	44
HCS-4891RDVS_S/80/2M	Fully Digital Congress System Delegate Unit (tabletop, discussion, voting, 64 CHs×2, 4.3" touch screen, rectangular columnar metal microphone, main microphone + backup microphone, silver microphone + black base)	46
HCS-4891RC_S/80/2M	Fully Digital Congress System Chairman Unit (tabletop, discussion, 4.3" touch screen, rectangular columnar metal microphone, main microphone + backup microphone, silver microphone + black base)	48

HCS-4891RD_S/80/2M	Fully Digital Congress System Delegate Unit (tabletop, discussion, 4.3" touch screen, rectangular columnar metal microphone, main microphone + backup microphone, silver microphone + black base).....	50
HCS-4838 Series Congress Units		53
HCS-4838CS/80	Fully Digital Congress System Chairman Unit (tabletop, discussion, 64 CHs, OLED screen, Braille, charcoal gray).....	53
HCS-4838DS/80	Fully Digital Congress System Delegate Unit (tabletop, discussion, 64 CHs, OLED screen, Braille, charcoal gray).....	55
HCS-4838C	Fully Digital Congress System Chairman Unit (tabletop, discussion, Braille, charcoal gray).....	57
HCS-4838D	Fully Digital Congress System Delegate Unit (tabletop, discussion, Braille, charcoal gray).....	59
HCS-4838R Series Congress Units		61
HCS-4838RCS/80	Fully Digital Congress System Chairman Unit (tabletop, discussion, 64 CHs, OLED screen, rectangular columnar metal microphone, Braille, black microphone + charcoal gray base).....	61
HCS-4838RDS/80	Fully Digital Congress System Delegate Unit (tabletop, discussion, 64 CHs, OLED screen, rectangular columnar metal microphone, Braille, black microphone + charcoal gray base).....	63
HCS-4838RC	Fully Digital Congress System Chairman Unit (tabletop, discussion, rectangular columnar metal microphone, Braille, black microphone + charcoal gray base).....	65
HCS-4838RD	Fully Digital Congress System Delegate Unit (tabletop, discussion, rectangular columnar metal microphone, Braille, black microphone + charcoal gray base).....	67
HCS-48U6 Series Congress Units		69
HCS-48U6MICM/80	Fully Digital Congress System Chairman Unit (flush-mounting, discussion, HCS-48U6DVOT and HCS-48U6SPK can be connected, black).....	69
HCS-48U6DMICM/80	Fully Digital Congress System Delegate Unit (flush-mounting, discussion, HCS-48U6DVOT and HCS-48U6SPK can be connected, black).....	71
HCS-48U6CMICS	Fully Digital Congress System Chairman Unit (flush-mounting, discussion, HCS-48U6SELM/80 needed, black).....	73
HCS-48U6DMICS	Fully Digital Congress System Delegate Unit (flush-mounting, discussion, HCS-48U6SELM/80 needed, black).....	75
HCS-48U6SELM/80	Flush-mounting 64-Channel Selector (HCS-48U6MICS, HCS-48U6VOT and HCS-48U6SPK can be connected, black).....	76
HCS-48U6DVOTTW	Fully Digital Voting Unit (flush-mounting, 3 voting keys, built-in contactless IC-Card slot, HCS-48U6SELM/80 or HCS-48U6MICM/80 needed, black).....	77
HCS-48U6DVOTTME/80	Fully Digital Voting System Delegate Unit (flush-mounting, 3 voting keys, black).....	78
HCS-48U6SPK	Flush-mounting Loudspeaker Panel (HCS-48U6SELM/80 or HCS-48U6MICM/80 needed, black).....	79
HCS-48U7 Series Congress Units		80
HCS-48U7CM/80	Fully Digital Congress System Chairman Unit (flush-mounting, discussion, built-in loudspeaker and 3.5mm TRS headphones jack, black).....	82
HCS-48U7DM/80	Fully Digital Congress System Delegate Unit (flush-mounting, discussion, built-in loudspeaker and 3.5mm TRS headphones jack, black).....	82
HCS-48U8 Series Congress Units		84
HCS-48U8CVSW/80	Fully Congress System Chairman Unit (flush-mounting, 5 voting keys, contactless IC-Card reader, 64 CHs, 256x32 LCD, black).....	84

HCS-48U8DVSW/80	Fully Digital Congress System Delegate Unit (flush-mounting, 5 voting keys, contactless IC-Card reader, 64 CHs, 256x32 LCD, black).....	86
HCS-48U9 Series Congress Units		87
HCS-48U9CVSW/80	Fully Digital Congress System Chairman Unit (flush-mounting, 5 voting keys, contactless IC-Card reader, 64 CHs, 256x32 LCD, black).....	87
HCS-48U9DVSW/80	Fully Digital Congress System Delegate Unit (flush-mounting, 5 voting keys, contactless IC-Card reader, 64 CHs, 256x32 LCD, black).....	90
HCS-48U10 Series Congress Units		92
HCS-48U10CVSE/80	Fully Digital Congress System Chairman Unit (flush-mounting, discussion, 3 voting keys, built-in contactless IC-Card slot, 64 CHs, OLED, black).....	92
HCS-48U10DVSE/80	Fully Digital Congress System Delegate Unit (flush-mounting, discussion, 3 voting keys, built-in contactless IC-Card slot, 64 CHs, OLED, black).....	94
HCS-48U10DVE/80	Fully Digital Congress System Delegate Unit (flush-mounting, discussion, 3 voting keys, built-in contactless IC-Card slot, black).....	96
HCS-48U10DS/80	Fully Digital Congress System Delegate Unit (flush-mounting, discussion, 64 CHs, OLED, black).....	98
HCS-48U10DDS/80	Fully Digital Congress System Delegate Unit (flush-mounting, discussion, 64 CHs, OLED, 2 channel selectors, dual predefined position, black).....	100
HCS-4860 Series Congress Units		102
HCS-4860CS_B/80	Fully Digital Congress System Chairman Unit (tabletop, discussion, rectangular columnar metal microphone, 64 CHs, OLED, black).....	102
HCS-4860DS_B/80	Fully Digital Congress System Delegate Unit (tabletop, discussion, rectangular columnar metal microphone, 64 CHs, OLED, black).....	104
HCS-4860C_B/80	Fully Digital Congress System Chairman Unit (tabletop, discussion, rectangular columnar metal microphone, black).....	106
HCS-4860D_B/80	Fully Digital Congress System Delegate Unit (tabletop, discussion, rectangular columnar metal microphone, black).....	108
HCS-4860/80/2M Series Congress Units		110
HCS-4860C_B/80/2M	Fully Digital Congress System Chairman Unit (tabletop, discussion, rectangular columnar metal microphone, main microphone + backup microphone, black).....	110
HCS-4860D_B/80/2M	Fully Digital Congress System Delegate Unit(tabletop, discussion, rectangular columnar metal microphone, main microphone + backup microphone, black).....	112
HCS-4860X/80 Series Congress Units		114
HCS-4860CX_B/80	Fully Digital Congress System Chairman Unit (tabletop, discussion, XLR connector for condenser microphone with +48 V phantom power, black, without microphone, HCS-1857/HCS-1858 series microphone is needed).....	114
HCS-4860DX_B/80	Fully Digital Congress System Delegate Unit (tabletop, discussion, XLR connector for condenser microphone with +48 V phantom power, black, without microphone, HCS-1857/HCS-1858 series microphone is needed).....	116
HCS-4860CXD_B/80	Fully Digital Congress System Chairman Unit (digital audio + analog audio dual system backup, XLR connector for condenser microphone with +48 V phantom power, black, without microphone, HCS-1857/HCS-1858 series microphone is needed).....	118
HCS-4860DXD_B/80	Fully Digital Congress System Delegate Unit (digital audio + analog audio dual system backup, XLR connector for condenser microphone with +48 V phantom power, black, without microphone, HCS-1857/HCS-1858 series microphone is needed).....	120

HCS-4813 Series Congress Terminals		123
HCS-4813C	Fully Digital Congress System Chairman Unit(tabletop, build-in microphone,5 keys voting, 64 CHs, Braille, black).....	123
HCS-4813D	Fully Digital Congress System Delegate Unit (tabletop, build-in microphone,5 keys voting, 64 CHs, Braille, black).....	124
HCS-4815C	Fully Digital Congress System Chairman Unit(tabletop, build-in microphone, Braille, black).....	125
HCS-4815D	Fully Digital Congress System Delegate Unit(tabletop, build-in microphone, Braille, black).....	127
HCS-484* Series Congress Units		130
HCS-4840DHT	Multi-function Connector (for connection to 4 pcs of HCS-4842DHT channel selector, silver)...	130
HCS-4841DMIC	Multi-function Connector (for connection to 2 microphones, +48 V phantom power, black).....	130
HCS-4842DHT	64-Channel Selector (flush-mounting, HCS-4840DHT needed, black).....	130
HCS-4842X4 64-Channel X 4 Portable Audio Distributor		131
HCS-4852T 8-pin Cable Splitter (1 input & 3 outputs, for HCS-4800 and HCS-8600 series)		132
HCS-4852TN RJ45 Port Splitter (1 input & 4 outputs, for HCS-4800 and HCS-8600 series)		132
HCS-4853T 6-pin to 8-pin Cable Splitter (input (6P-DIN) & 3 outputs (8P-DIN), for connection between HCS-8685 Interpretation Unit and HCS-8300M series, HCS-4100M/50 series, HCS-5100MA/B series)		132
HCS-4800M Series Digital Congress System Main Units		133
HCS-4800MA/20	Fully Digital Congress System Main Unit (discussion, voting, 64 CHs, single-mode optical fiber interface).....	133
HCS-4800MB/20	Fully Digital Congress System Main Unit (discussion, voting, built-in PA).....	135
HCS-4800MC	Fully Digital Congress System Main Unit (discussion, voting).....	137
HCS-4800 Series Web Software		140
HCS-4800WS/MC	Web Software for Microphone Control.....	140
HCS-4800WS/AO	Web Software for Audio Output.....	140
HCS-4800WS/VT	Web Software for Video Track.....	140
HCS-4800 Series Application Software		142
HCS-4510	Basic System Setup Management Software.....	142
HCS-4512	Professional Venue Design Software.....	147
HCS-4512S	Professional Venue Design Software (Independent setup).....	147
HCS-4513	Microphone Management Software.....	148
HCS-4514	Voting Management Software (including delegate management, multiform voting, multi-proposal voting).....	149
HCS-4515	Video Control Software.....	151
HCS-4516	Simultaneous Interpretation Software.....	152
HCS-4518	Intercom Software.....	152
HCS-4519	Synchronous Audio Recording Management Software.....	153
HCS-4521	Multi-User Conference Control Software.....	153
HCS-4522	Dual PC Server Hot Spare Software.....	154
HCS-4525	Dual System Main Unit Hot Spare Software.....	154

HCS-4526	Touched/Contactless IC-Card Sign-in Management Software.....	155
HCS-4529	Fingerprint Identification Management Software.....	155
HCS-4531	Electronic Nameplate Management Software (for controlling HCS-1082 series E-ink nameplate, works with congress main unit, can be bounded to conference unit once connected).....	156
HCS-4532	Electronic Nameplate Management Software (for controlling HCS-1082N series E-ink nameplate via network, works without congress main unit, HCS-4512S needed).....	157
HCS-4539	Congress Service Management Software.....	158
HCS-4544S	Booth Management Software (HCS-8600MIO and HCS-8685BM needed).....	159
HCS-4547	Internet Extended Screen	160

HCS-4800 Series New Premium Digital Congress System

Overview

By using TAIDEN originated MCA-STREAM (Multi_Channel_Audio STREAM) digital processing and transmitting technologies, TAIDEN HCS-4800 Series New Premium Digital Congress System revolutionizes conference systems technology by incorporating the latest fully digital technologies, audio technologies and network techniques. Furthermore, with perfect integration of TAIDEN Conference Sign-in System and Central Control System, HCS-4800 takes the leadership in providing comprehensive and efficient digital conference system solutions.

"Closed Loop - Daisy Chain" connection technology, to connect all congress units and simplifying installation, as well as dual connection backup have been opted for.

By supporting 48 kHz audio sampling rate, all 64 channels feature a 20 Hz to 20 kHz frequency response.

● MCA-STREAM multi-channel audio digital transmitting technology

TAIDEN proprietary MCA-STREAM technology is the essential data transmission technology in the HCS-4800 system, e.g. transmitting up to 64 CHs high quality digital, control and other information data over a single dedicated 100 Mbps high speed 8-pin cable or cat5e cable with a drain wire. Every unit - congress main unit, congress unit, language distribution unit, interpreter unit - is equipped with a high performance CPU as the kernel of the advanced technology infrastructure.

By virtue of using the MCA-STREAM technology, HCS-4800 Series New Premium Digital Congress System carries out:

- ◆ Ease of system cabling and enhancement of system reliability by utilizing a single dedicated 8-pin cable or cat5e cable with a drain wire to transmit up to 64 CHs floor and interpretation language signals, avoiding the necessity to use complicated multi-core cables.
- ◆ Prevention of noise caused by the ground wire in stereo projects as well of interference brought by other equipment (such as stage lights, recording apparatus, etc.). SNR reaches 100 dB and isolation is better than 85 dB. The frequency response verges on 20 Hz to 20 kHz; making the system sound approaching CD quality.
- ◆ Provision of Hi-Fi sound quality, even in long range transmission, which makes the system widely suitable for various applications such as mini/medium type meeting rooms, large venues, stadiums, etc.

● HCS-4800 system hardware structure

HCS-4800 system hardware is an embedded structure based on dual high performance CPU. Even in stand-alone mode, HCS-4800 is competent for the management of various meetings via several

basic conference management facilities, such as basic microphone management, electronic voting, multilingual simultaneous interpretation, etc.

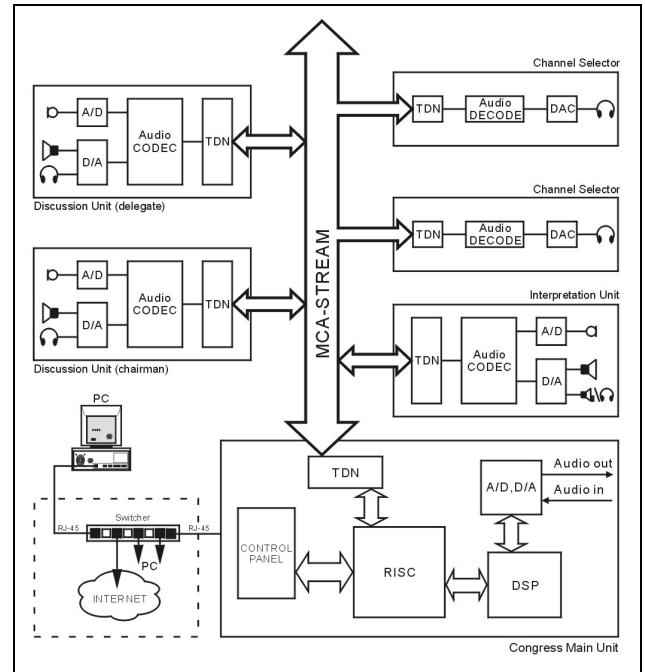

In the figure above:

- Audio CODEC: Dedicated audio coding and decoding chip of discussion unit and interpreter unit
- TDN: Dedicated digital communication chip for TAIDEN digital congress system networking
- DAC: Digital-to-analog conversion chip
- RISC: Central processing chipset of congress main unit, controlling the DSP and AD/DA conversion IC to provide 2-channel audio line in/out and record in/out facilities

Based on advanced hardware, HCS-4800 system features high security software, easy to operate, convenient to maintain and to upgrade. The meeting is fully controlled and monitored by the operator.

● Modular system structure

Any kind of configuration can be set up just by daisy-chaining HCS-4800 congress units. The modular system structure of HCS-4800 is applicable to any kind of conference and provides an accurate and efficient solution. Additional congress units can be added when needed. More system functions are available in connection with a PC and control software.

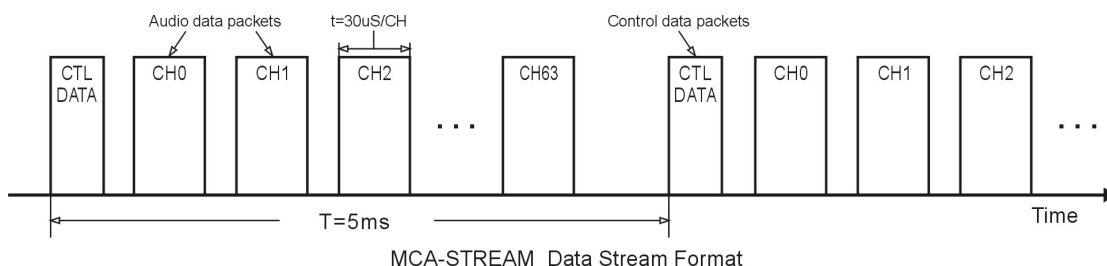

● Dual Congress main unit Hot Spare Module

HCS-4800 dual main unit hot spare is a disaster protective structure. Besides the main unit, the user can set another CMU as backup CMU and connect it to the system. If the main unit breaks down during the conference, the backup main unit substitutes the main unit and the system software will connect to backup CMU automatically, ensuring the consistency of the conference.

● HCS-4800 system software infrastructure

HCS-4800 system software is designed for the prevalent Client/Server structure. Client and server communicate with each other by using TCP/IP network protocol, ensuring both data security and transmission efficiency. Client and server software can run on the same computer as well as on different computers in the same LAN, enabling the operator to manage the conference more flexibly. HCS-4800 system software imports the hot-spare dual server structure by using a main server and a back-up server. While the main server is processing, data are stored real time on the back-up server to prevent conference related information from loss in case of a crash of the main server. As a result, security and reliability of the conference system are improved vitally.

● Duplicate and backup connection via “Closed Loop - Daisy Chain” connection

For important meetings, especially those which consider connection reliability as their leading point, HCS-4800 Series New Premium Digital Congress System adopts advanced "Closed Loop - Daisy Chain" connection topology, connecting the last unit in the loop back to the congress main unit. Therefore, any congress unit in the loop has two connection paths to the congress main unit. As a result, breakdown or replacement of a congress unit and connection failure of a cable will not influence other congress units. As such the system features the advantages of a daisy-chain connection system with its simplicity of cabling as well as the improvement of the system reliability through duplicate and backup connection functions.

● Advanced TCP/IP communication protocol in PC control

In a PC controlled system, the congress main unit and the PC use the advanced TCP/IP protocol. Theoretically, the communication distance between the PC and the CMU can be infinite. This is decisively different to traditional RS232 connection modes where the distance between the PC and the CMU cannot exceed 15 meters. TCP/IP enables remote control, remote diagnosis and remote update.

By using network techniques, conference systems are tightly linked to the rapidly developing internet technology, computer science and communication technology. Users enjoy the convenience of the contemporary leading techniques, e.g. by using the compatible wireless LAN techniques (802.11) - such as PDAs - which can be used to control a conference system wirelessly. The import of network topology also makes the conference system merge with intelligent building networks.

● CMU and EMU

The congress main unit forms the core of the entire congress system. It provides power supply to all contribution units and serves as key component to link system hardware to application software. One CMU has two (8P-DIN) trunk-line cable outlets. If more congress units are needed, additional extension main units HCS-8600MEA or HCS-8300MEA2 are required, each EMU has

five (8P-DIN) trunk-line cable outlets. HCS-4800 system maximum capacity: 378 interpreter units (63 interpreter booths, 6 interpreter units in each), 4096 discussion/voting units and any number of channel selectors.

In stand-alone mode without a PC, the CMU carries out basic management facilities, simultaneous interpretation, electric voting and 64 CHs digital audio transmission. By operating HCS-4800 application software in PC-controlled mode, more comprehensive management facilities can be implemented.

● Contribution units

Contribution units are units used by participants to contribute to a conference and include: discussion unit (chairman/delegate), voting unit, interpreter unit, channel selector, etc. The basic contribution unit has discussion, voting or channel select facility. The upgraded units combine discussion, voting and channel select, furthermore built-in loudspeaker, IC-Card reader and graphic 256x32/256x64 LCD with back-lighting, forming a wide variety of product series. The chairman unit has microphone priority facility with a priority button to switch off or to mute speaking units. If required, different functions can be allocated to delegate stations, including listening, discussion, request to speak, voting, IC-Card sign-in, short message, information display, etc.

Depending on the option, congress units can be divided into tabletop, flush-mounted and component. Each style consists of various products, which significantly enriches users' choices.

Low power consumption design is adopted in HCS-8600 and HCS-4800 series congress units, convenient for wiring and installation.

All congress units of HCS-8600 and HCS-4800 series (except HCS-8368/8668/8638/8665 series) are supplied by the main unit's 8P-DIN interface. Since the power capacity of the 8P-DIN interface is limited, it must be ensured during installation that the added up values of a) the total power consumption of all congress units connected in each path and b) the power loss in extension cables do in no case exceed the maximum possible value delivered by each 8P-DIN interface. Otherwise the system will not work properly or automatic protection will be triggered.

● Application software

HCS-4800 application software is comprehensive, reliable and user-friendly. It is also an easy-care software system which helps the operator to manage the conference efficiently from the very beginning of a meeting until the post-meeting work. Once the PC installed and the HCS-4800 application software integrated into the HCS-4800 system, the operator manages all aspects of the conference centrally. The operation turns out to be easy and efficient.

HCS-4800 software applications have various parts: System Setup Management Software, Microphone Management Software, Voting Management Software, Simultaneous Interpretation Software, Intercom Software, Synchronous Audio Recording Management Software, Multi-User Conference Control Management Software, Dual PC Server Hot Spare Software, Agenda Control Software, Dual System Main Unit Hot Spare Software, etc.



● **Installation and transportation**

Easy installation is another important feature of HCS-4800 system. HCS-4800 digital congress units have a 1.5-meter 8P-DIN cable (with male connector) and a 0.6-meter 8P-DIN cable (with female connector) or have two RJ45 sockets (cat5e cable with a drain wire & RJ45 plug with metal shield for connection). All congress units are connected together in a daisy chain configuration and connected to the main unit by the dedicated extension cable.

Functions

Discussion

- ✧ "Active microphones" (1~8), sets the number of delegates permitted to speak at the same time, and sets speaking time limit function
- ✧ Five discussion modes:
 - "Open" mode, microphone On/Off button with request-to-speak registration (AUTO)
 - "Override" mode, microphone On/Off button control with override of the active microphones (FIFO)
 - "Voice" mode, acoustic active sensitivity and automatic switch-off time adjustable continuously, built-in "flash-on" technology, immediate microphone activation on speaking
 - "Request" mode, delegate requests to speak by pressing microphone On/Off button, delegate only speaks when operator or chairman approved his application
 - "PTT" mode, press microphone On/Off button to talk
- ✧ VIP unit configurable:
 - By using HCS-4800 application software, a maximum of 32 delegate units can be set as VIP units
 - VIP unit can be activated in any mode freely, as long as the total number of active microphones does not exceeded 8 (including chairman / delegate / VIP)
- ✧ Gain and EQ (5 band) of each microphone adjustable separately, fitting the individual orator's voice to achieve perfect speech pickup any time
- ✧ Integrated high-pass filter (low-cut switch) to cut low frequency elements from the audio when needed

● 64 CHs simultaneous interpretation

- ✧ Supporting 48 kHz audio sampling rate, all 64 channels perfectly reproducing audio frequencies between 20 Hz and 20 kHz
- ✧ HCS-4800 system can accommodate 378 simultaneous interpreter units (63 interpreter booths, 6 interpreter units in each), and provide 64 CHs (including floor language) simultaneous interpretation
- ✧ The interpreter unit is equipped with an uni-directional electret condenser microphone. Gain and EQ (5 band) of each microphone adjustable separately for different acoustic features to get perfect sound performance for different orators. It features also 5 pre-defined input channels and 3 output interpretation channels and their corresponding short keys, high lightness 256×64 graphic LCD with back-lighting, built-in IC-Card reader and audio record and playback function
- ✧ Delegates use channel select to listen to different languages. In cooperation with channel selectors and/or infrared language distribution system, a larger listening audience can join in the meeting

● Voting

- ✧ If the system is equipped with a chairman unit with a graphic LCD, parliamentary voting (YES/NO/ABSTAIN) can be implemented even without a PC. The result is displayed on the LCD of every contribution unit
- ✧ Dedicated software for more forms of voting:
 - For/Against
 - Parliamentary: YES/NO/ABSTAIN

- Questionnaire: 1/2/3/4/5
- Audience response: --/-/0/+/>++
- Parliamentary (NPPV): YES/NO/ABSTAIN/NPPV
- Appraisal:
 - ✧ Satisfied (four keys voting: perfectly satisfied/satisfied/basically satisfied/unsatisfied) (three keys voting: satisfied/basically satisfied/unsatisfied) (two keys voting: satisfied/unsatisfied)
 - ✧ Qualified (four/three/two keys voting)
 - ✧ Competent (four/three/two keys voting)

● Information display

- ✧ By using the information display module of the HCS-4800 application software, conference title, content, conference related information as well as meeting related notice can be displayed on large screen display (or projector).
- ✧ Contribution units equipped with graphic 256x32 LCD show:
 - Active microphone amount, request amount, delegates' signed-in and voting results, etc.
 - Messages (messages from system administrator to all or part of participants)
 - Multilingual (simplified/traditional Chinese and English, etc.) menu
- ✧ Contribution units equipped with 128x36 OLED show:
 - English menu
 - Channel number and language name

● Automatic video tracking system

Automatic video tracking can be carried out with video switch unit and camera.

● Remote control and remote diagnosis

Using advanced TCP/IP network protocol in communication between PC and CMU - to implement remote control, remote diagnosis and remote update for the conference system - for easy central control of a multi-room configuration.

● Intercom

The built-in intercom facility allows bidirectional vocal communication between conference participants, interpreters and operators, if an operator unit is in the system. Extra equipment is not required.

● Multi-room configuration function

Several main units can constitute several independent conference systems, or can be combined together easily as a large multi-room conference system configuration.

● Integrated optical fiber interface

Optical fiber interface is integrated into HCS-4800MA congress main unit, in cooperation with HCS-8600 series extension main unit, audio input & output device. Thus several mutually distant conference rooms can be combined and be operated as one venue. HCS-4800MA congress main unit and HCS-8600 series extension main unit can be connected by optical fiber or Cat.5e cable.

● Seamlessly Integrated with conference sign-in system and central control system

The seamless integration of HCS-4800 Series New Premium Digital

Congress System, TAIDEN conference sign-in system and central control system provides comprehensive conference system solutions. Besides the basic conference management (discussion, voting, simultaneous interpretation, video tracking, etc.), it also provides conference sign-in and access control for the conference participants. Furthermore, it gives complete facilities to manage conference system power supply and peripheral multimedia equipment, surrounding lights, projector display and sound equipment. The easy incorporation of peripheral components upgrades the system into an advanced intelligent conference system with integrated solutions for conferencing, audio, lighting control, etc.

- **Fully compatible with TAIDEN HCS-8600 Series Paperless Multi-media Congress System**

Fully compatible with TAIDEN HCS-8600 Series Paperless Multimedia Congress System: HCS-8600 series congress units can be connected to the HCS-4800 system, and HCS-4800 series congress units can be connected to the HCS-8600 system (exclusive functions only available with HCS-8600 contribution units).

- **Other facilities**

- ◇ With the multi-channel audio input & output device (several units cascable), multi-channel audio signals are available as output signals for infrared language distribution system or recording
- ◇ Built-in self-detecting functions in each contribution unit for automatic detection of microphone and keys

Features

● System reliability

System reliability, as described below, has always been the guiding principle while designing HCS-4800 series fully digital conference system:

- ✧ Dual congress main unit hot spare
- ✧ System software imports the hot-spare dual server structure by operating the main server and the back-up server at the same time
- ✧ Dual connection backup is implemented between HCS-4800MA congress main unit and HCS-8600MEA extension main unit via optical fiber and Cat.5 cable
- ✧ "Closed Loop - Daisy Chain" connection topology, breakdown or replacement of a congress unit and connection failure of a cable will not influence other congress units
- ✧ Built-in communication auto termination function to prevent system collapse if the TCP/IP cable is pulled out
- ✧ Auto recovery function, supports "PnP"
- ✧ If PC malfunction happens, CMU will return to control status automatically and take over control of the meeting, ensuring continuation of the meeting process

● System technological progress

HCS-4800 Series New Premium Digital Congress System - based on TAIDEN originated independent intellectual property rights digital processing and transmitting technologies MCA-STREAM - adopts embedded hardware structure based on high performance dual CPU. HCS-4800 application software is based on Client/Server and hot-spare dual server structure. CMU and PC use advanced TCP/IP protocol for communication, perfectly integrated to benefit from modern technologies.

Furthermore, conference sign-in system and central control system can be integrated into TAIDEN HCS-4800 Series New Premium Digital Congress System to provide the first complete and efficient solution in the world.

● System operability

CMU controls efficiently: basic microphone control, simultaneous interpretation, video tracking, voting - without the intervention of an operator.

With a PC and HCS-4800 application software, more functions can be achieved, including enhanced microphone control, simultaneous interpretation, delegate information management, sign-in control, meeting data management and distribution, voting control and output audio processing. HCS-4800 application software can also be set up according to user requirements.

HCS-4800 application software adopts Client/Server structure - the process of the meeting is controlled by the operator from any PC within the same LAN. If PC malfunction occurs, CMU will return to control status automatically and take over control of the meeting, ensuring continuation of the meeting.

● Fine extensibility

The interpreter unit of HCS-4800 has a maximum of 64 channels (including floor channel) and satisfies the requirements of large-scale international meetings: allocating a language for each channel, selecting a channel, interlock facility. To avoid reciprocal interference and crosstalk the language of each channel can be

released separately. The system supports a maximum of 4096 congress units and an infinite number of channel selectors.

HCS-4800 system is modular just daisy-chain HCS-4800 units to set-up a configuration. If extra system capacity is needed, units can be connected easily, starting from any access point.

● Economical and convenient installation

In virtue of the fully digital techniques of HCS-4800 system, system installation becomes simple and economical, especially in conjunction with the economical and durable HCS-4800 system dedicated 8-PIN cable or cat5e cable with a drain wire. The cable, suitable for the requirements of any kind of meeting, transmits up to 64 high quality audio signals, control data and information simultaneously.

An ID can be assigned by default or manually to each conference unit bearing a unique serial number for convenient maintenance.

System connection reliability is improved by the professional 8P-DIN standard plug and clasp which facilitates system installation as well as disassembly. Cat5e Ethernet cable with a drain wire can be used as connection cable and extension cable. As a result of the daisy-chain design of the contribution units, insertion into the system can be done at any desired point, simplifying equipment extension and maintenance significantly.

● System maintenance

TAIDEN application software provides testing functions for online testing the operating conditions such as validity of the keys, LCD and microphones.

A detailed test report is issued for quick and simple maintenance of the system device.

System environmental conditions

- **Temperature range:**
 - ✧ Transport: -40 °C ~ +70 °C
 - ✧ Operating: 0 °C ~ +45 °C
- **Humidity range:**
 - ✧ Max. relative humidity: <95%
- **Safety: Compliant to EN60065**
- **EMC emission: Compliant to EN55022**
- **EMC immunity: Compliant to EN 55024**
- **EMC approvals: CE, FCC**
- **Power harmonics: Compliant to EN61000-3-2**
- **Voltage fluctuations and flicker: EN61000-3-3**

Acquired certifications

- **UK royalty UKAS ISO9001:2015 quality system authentication**
- **CE authentication (safety and electromagnetic compatibility)**
- **FCC authentication**

HCS-4890NCVSE/80 Chairman Unit with Voting and Channel Selection



Features

- Elegant and ergonomic design
- Exquisite and delicate tabletop design for ease of use and transport
- Cable coming out of the base for a tidier wiring
- Hi-Fi loudspeaker
- Priority button
- Pluggable microphone
- 5 voting keys
- Exquisite and sleek 4.3" touch screen for information display of meeting proceedings
- Supports custom boot screen and background picture
- "Closed Loop - Daisy Chain" connection topology
- Intuitive language list and volume control for quick channel switch and volume adjustment on the screen
- Transmitting up to 64 CHs high quality digital audio signals on a dedicated 8-pin cable
- Supporting 48 kHz audio sampling rate, all 64 channels perfectly reproducing audio frequencies between 20 Hz and 20 kHz
- Excellent immunity to RF interference from mobile phones
- Separate adjustment of gain and EQ (5 band) of each microphone for the perfect sound
- Supporting "PnP" (plug and play)
- Built-in contactless IC-Card reader
- Braille is present for all physical buttons

The stylish and ergonomically designed chairman unit has all the necessary facilities to enable the user to chair a conference. It has excellent immunity to RF interference from mobile phones. Similar in appearance to HCS-4890NDVSE/80 Delegate Unit, the HCS-4890NCVSE/80 Chairman Unit includes a microphone priority button. When pressed, the priority button causes all currently active delegate microphones to be switched off temporarily or permanently, allowing the chairman to take control of the meeting. A 4.3" touch screen can display speaking list, sign-in and voting information, channel number and language name, operation menu, etc. Channel selection is automatically limited to the number of language channels available. The loudspeaker offers superior acoustics with minimal feedback for enhanced intelligibility.

Functions

- Compliant to ISO 22259
- "Closed Loop - Daisy Chain" connection topology for a high operational system reliability: breakdown or replacement of a congress unit and connection failure of a cable will not influence other congress units
- Based on TAIDEN originated MCA-STREAM digital audio processing and transmitting technologies
- Proprietary MCA-STREAM technology used to transmit fully digital audio between the congress units as well as between congress units and main unit(s)
- Audio signals processed by high performance DSP: sound quality approaching CD quality
- Gain and EQ (5 band) of each microphone adjustable separately, fitting the individual orator's voice to achieve perfect speech pickup any time
- Transmitting up to 64 CHs high quality digital audio signals on a dedicated 8-pin cable (general cat5e cable with a drain wire substitutable)
- Supports up to 64 (1+63) CHs simultaneous interpretation
- Supports 48 kHz audio sampling, and all 64 channels perfectly reproducing audio frequencies between 20 Hz and 20 kHz
- Intuitive language list and volume control for quick channel switch and volume adjustment on the screen
- Integrated high-pass filter (low-cut switch) to cut low frequency elements from the audio when needed
- Automatic system recovery and "PnP" (plug and play)
- Stem microphone can be unplugged during adjournment, easy to maintain
- Mini-microphone, with foam windshield
- Hi-Fi loudspeaker, minimal feedback, mutes automatically when microphone is active
- Excellent immunity to RF interference from mobile phones and comparable devices
- Microphone On/Off button, 5 voting keys
- An ID can be assigned by default or manually to each conference unit bearing a unique serial number for convenient maintenance
- Facilities in independent operation from computer:
 - ◆ Set the number of delegates permitted to speak at the same time
 - ◆ Speak mode: Open/Override/Voice/Request/PTT
 - "Open" mode, microphone On/Off button with request-to-speak registration (AUTO)
 - "Override" mode, microphone On/Off button control with override of the active microphones (FIFO)
 - "Voice" mode, acoustic active sensitivity and automatic switch-off time adjustable continuously, built-in "flash-on" technology, immediate microphone activation on speaking
 - "Request" mode, delegate requests to speak by pressing microphone On/Off button, delegate only speaks when operator or chairman approved his application
 - "PTT" mode, press microphone On/Off button to talk
 - ◆ Simultaneous interpretation
- Multifunction voting function can be implemented in combination with the corresponding software
- Key-press sign-in, contactless IC-Card sign-in
- Built-in contactless IC-Card slot to place the IC card, while automatically logout once the card is taken out from the slot

- Braille is present for all physical buttons
- Automatic video tracking implementation when cooperating with cameras & video switcher unit; preset positions on PC
- Activation at any time (if the amount of active microphones in the system is less than 8)
- Priority button to switch off or to mute the delegate units (except VIP units) according to preset
- Approves/denies delegates' speaking request
- System supports up to 100 chairman units, while all or part chairman units have the control facilities listed above (set by software or main unit)

Controls and Indicators

- 4.3" touch screen for displaying:
 - ◆ Speaking list, timing speaking information, delegate information
 - ◆ Sign-in and voting information
 - ◆ Language channel and earphone volume adjustment
 - ◆ Screen brightness, system language and unit information
- Built-in channel selector with channel selection function
- Uni-directional electret condenser microphone with bi-color illuminated ring
- Headphones volume control
- Five voting keys
- Microphone On/Off button with indicator
- Priority button

Interconnections

- Socket for pluggable microphone
- Ø 3.5 mm stereo headphone jack
- Contactless IC-Card slot
- 1.5 m cable with 8P-DIN plug
- 0.6 m cable with 8P-DIN socket

Technical Specifications

Electrical

Max. consumption.....3.6 W

Headphone connection

Frequency response.....20 Hz to 20 kHz

Earphone load impedance.....>16 Ohm

Earphone output.....10 mW

LCD

Dimension.....4:3

Resolution.....800×480

Contrast.....800:1

Recommended microphone type

Transducer.....Electret-condenser

Polar pattern.....Uni-directional

Operating voltage.....5 VDC

Sensitivity.....-46 dBV/Pa

Frequency response.....50 Hz to 20 kHz

Input impedance.....2 kOhm

Directivity 0°/180°.....> 20 dB (1 kHz)

Equivalent noise.....20 dBA (SPL)

Maximum sound pressure level.....125 dB (THD<3%)

Interface data

Connector.....Ø 3.5 mm stereo jack for headphone

Mechanical

Mounting.....Tabletop

Dimensions (h x w x d) (w/o stem microphone).....60 x 240 x 101 mm

Weight (incl. stem microphone).....1.1 kg

Color.....Black (PANTONE 419 C)

Stem length.....330 mm, 410 mm (standard version), 470 mm

Ordering Information

HCS-4890NCVSE_B/80...Fully Digital Congress System Chairman Unit (tabletop, discussion, 5 voting keys, built-in contactless IC-Card slot, 64 CHs, 4.3" touch screen, Braille, black)

HCS-4890NDVSE/80 Delegate Unit with Voting and Channel Selection



Features

- Elegant and ergonomic design
- Exquisite and delicate tabletop design for ease of use and transport
- Cable coming out of the base for a tidier wiring
- Hi-Fi loudspeaker
- Pluggable microphone
- 5 voting keys
- Exquisite and sleek 4.3" touch screen for information display of meeting proceedings
- Supports custom boot screen and background picture
- "Closed Loop - Daisy Chain" connection topology
- Intuitive language list and volume control for quick channel switch and volume adjustment on the screen
- Transmitting up to 64 CHs high quality digital audio signals on a dedicated 8-pin cable
- Supporting 48 kHz audio sampling rate, all 64 channels perfectly reproducing audio frequencies between 20 Hz and 20 kHz
- Excellent immunity to RF interference from mobile phones
- Separate adjustment of gain and EQ (5 band) of each microphone for the perfect sound
- Supporting "PnP" (plug and play)
- Built-in contactless IC-Card reader
- Braille is present for all physical buttons

The multi-functional delegate unit meets the demands of even the largest conferences. It provides facilities for speaking, registering a request-to-speak, listening, voting, selecting language channels and IC-Card sign-in. Excellent immunity to RF interference from mobile phones. A 4.3" touch screen can display speaking list, sign-in and voting information, channel number and language name, operation menu, etc. Channel selection is automatically limited to the number of language channels available.

The loudspeaker offers superior acoustics with minimal feedback for enhanced intelligibility.

Functions

- Compliant to ISO 22259
- "Closed Loop - Daisy Chain" connection topology for a high operational system reliability: breakdown or replacement of a congress unit and connection failure of a cable will not influence other congress units
- Based on TAIDEN originated MCA-STREAM digital audio processing and transmitting technologies
- Proprietary MCA-STREAM technology used to transmit fully digital audio between the congress units as well as between congress units and main unit(s)
- Audio signals processed by high performance DSP: sound quality approaching CD quality
- Gain and EQ (5 band) of each microphone adjustable separately, fitting the individual orator's voice to achieve perfect speech pickup any time
- Transmitting up to 64 CHs high quality digital audio signals on a dedicated 8-pin cable (general cat5e cable with a drain wire substitutable)
- Supports up to 64 (1+63) CHs simultaneous interpretation
- Supports 48 kHz audio sampling, and all 64 channels perfectly reproducing audio frequencies between 20 Hz and 20 kHz
- Intuitive language list and volume control for quick channel switch and volume adjustment on the screen
- Integrated high-pass filter (low-cut switch) to cut low frequency elements from the audio when needed
- Automatic system recovery and "PnP" (plug and play)
- Stem microphone can be unplugged during adjournment, easy to maintain
- Mini-microphone, with foam windshield
- Hi-Fi loudspeaker, minimal feedback, mutes automatically when microphone is active
- Excellent immunity to RF interference from mobile phones and comparable devices
- Microphone On/Off button, 5 voting keys
- An ID can be assigned by default or manually to each conference unit bearing a unique serial number for convenient maintenance
- Facilities in independent operation from computer:
 - ◆ Set the number of delegates permitted to speak at the same time
 - ◆ Speak mode: Open/Override/Voice/Request/PTT
 - "Open" mode, microphone On/Off button with request-to-speak registration (AUTO)
 - "Override" mode, microphone On/Off button control with override of the active microphones (FIFO)
 - "Voice" mode, acoustic active sensitivity and automatic switch-off time adjustable continuously, built-in "flash-on" technology, immediate microphone activation on speaking
 - "Request" mode, delegate requests to speak by pressing microphone On/Off button, delegate only speaks when operator or chairman approved his application
 - "PTT" mode, press microphone On/Off button to talk
 - ◆ Simultaneous interpretation
- Multifunction voting function can be implemented in combination with the corresponding software
- Key-press sign-in, contactless IC-Card sign-in

- Built-in contactless IC-Card slot to place the IC card, while automatically logout once the card is taken out from the slot
- Braille is present for all physical buttons
- Automatic video tracking implementation when cooperating with cameras & video switcher unit; preset positions on PC
- Set any delegate unit to be VIP unit
 - ◆ Up to 32 units can be set as VIP in one system via application software
 - ◆ VIP unit can be activated as long as the total of active microphones is not beyond 8 (incl. chairman/delegate/VIP unit)

Controls and Indicators

- 4.3" touch screen for displaying:
 - ◆ Speaking list, timing speaking information, delegate information
 - ◆ Sign-in and voting information
 - ◆ Language channel and earphone volume adjustment
 - ◆ Screen brightness, system language and unit information
- Built-in channel selector with channel selection function
- Uni-directional electret condenser microphone with bi-color illuminated ring
- Headphones volume control
- Five voting keys
- Microphone On/Off button with indicator

Interconnections

- Socket for pluggable microphone
- Ø 3.5 mm stereo headphone jack
- Contactless IC-Card slot
- 1.5 m cable with 8P-DIN plug
- 0.6 m cable with 8P-DIN socket

Technical Specifications

Electrical

Max. consumption.....3.6 W

Headphone connection

Frequency response.....20 Hz to 20 kHz

Earphone load impedance.....>16 Ohm

Earphone output.....10 mW

LCD

Dimension.....4:3

Resolution.....800×480

Contrast.....800:1

Recommended microphone type

Transducer.....Electret-condenser

Polar pattern.....Uni-directional

Operating voltage.....5 VDC

Sensitivity.....-46 dBV/Pa

Frequency response.....50 Hz to 20 kHz

Input impedance.....2 kOhm

Directivity 0°/180°.....> 20 dB (1 kHz)

Equivalent noise.....20 dBA (SPL)

Maximum sound pressure level.....125 dB (THD<3%)

Interface data

Connector.....Ø 3.5 mm stereo jack for headphone

Mechanical

Mounting.....Tabletop

Dimensions (h x w x d) (w/o stem microphone).....60 x 240 x 101 mm

Weight (incl. stem microphone).....1.1 kg

Color.....Black (PANTONE 419 C)

Stem length.....330 mm, 410 mm (standard version), 470 mm

Ordering Information

HCS-4890NDVSE_B/80.....Fully Digital Congress System Delegate Unit (tabletop, discussion, 5 voting keys, built-in contactless IC-Card slot, 64 CHs, 4.3" touch screen, Braille, black)

HCS-4890NCS/80 Chairman Unit with Channel Selection



Features

- **Elegant and ergonomic design**
- **Exquisite and delicate tabletop design for ease of use and transport**
- **Cable coming out of the base for a tidier wiring**
- **Hi-Fi loudspeaker**
- **Priority button**
- **Pluggable microphone**
- **Exquisite and sleek 4.3" touch screen for information display of meeting proceedings**
- **Supports custom boot screen and background picture**
- **"Closed Loop - Daisy Chain" connection topology**
- **Intuitive language list and volume control for quick channel switch and volume adjustment on the screen**
- **Transmitting up to 64 CHs high quality digital audio signals on a dedicated 8-pin cable**
- **Supporting 48 kHz audio sampling rate, all 64 channels perfectly reproducing audio frequencies between 20 Hz and 20 kHz**
- **Excellent immunity to RF interference from mobile phones**
- **Separate adjustment of gain and EQ (5 band) of each microphone for the perfect sound**
- **Supporting "PnP" (plug and play)**

The stylish and ergonomically designed chairman unit has all the necessary facilities to enable the user to chair a conference. It has excellent immunity to RF interference from mobile phones. Similar in appearance to HCS-4890NDS/80 Delegate Unit, the HCS-4890NCS/80 Chairman Unit includes a microphone priority button. When pressed, the priority button causes all currently active delegate microphones to be switched off temporarily or permanently, allowing the chairman to take control of the meeting. A 4.3" touch screen can display speaking list, channel number and language name, operation menu, etc. Channel selection is automatically limited to the number of language channels available. The loudspeaker offers superior acoustics with minimal feedback for enhanced intelligibility.

Functions

- Compliant to ISO 22259
- "Closed Loop - Daisy Chain" connection topology for a high operational system reliability: breakdown or replacement of a congress unit and connection failure of a cable will not influence other congress units
- Based on TAIDEN originated MCA-STREAM digital audio processing and transmitting technologies
- Proprietary MCA-STREAM technology used to transmit fully digital audio between the congress units as well as between congress units and main unit(s)
- Audio signals processed by high performance DSP: sound quality approaching CD quality
- Gain and EQ (5 band) of each microphone adjustable separately, fitting the individual orator's voice to achieve perfect speech pickup any time
- Transmitting up to 64 CHs high quality digital audio signals on a dedicated 8-pin cable (general cat5e cable with a drain wire substitutable)
- Supports up to 64 (1+63) CHs simultaneous interpretation
- Supports 48 kHz audio sampling, and all 64 channels perfectly reproducing audio frequencies between 20 Hz and 20 kHz
- Intuitive language list and volume control for quick channel switch and volume adjustment on the screen
- Integrated high-pass filter (low-cut switch) to cut low frequency elements from the audio when needed
- Automatic system recovery and "PnP" (plug and play)
- Stem microphone can be unplugged during adjournment, easy to maintain
- Mini-microphone, with foam windshield
- Hi-Fi loudspeaker, minimal feedback, mutes automatically when microphone is active
- Excellent immunity to RF interference from mobile phones and comparable devices
- Microphone On/Off button
- An ID can be assigned by default or manually to each conference unit bearing a unique serial number for convenient maintenance
- Facilities in independent operation from computer:
 - ◆ Set the number of delegates permitted to speak at the same time
 - ◆ Speak mode: Open/Override/Voice/Request/PTT
 - "Open" mode, microphone On/Off button with request-to-speak registration (AUTO)
 - "Override" mode, microphone On/Off button control with override of the active microphones (FIFO)
 - "Voice" mode, acoustic active sensitivity and automatic switch-off time adjustable continuously, built-in "flash-on" technology, immediate microphone activation on speaking
 - "Request" mode, delegate requests to speak by pressing microphone On/Off button, delegate only speaks when operator or chairman approved his application
 - "PTT" mode, press microphone On/Off button to talk
 - ◆ Simultaneous interpretation
- Braille is present for all physical buttons
- Automatic video tracking implementation when cooperating with cameras & video switcher unit; preset positions on PC

- Activation at any time (if the amount of active microphones in the system is less than 8)
- Priority button to switch off or to mute the delegate units (except VIP units) according to preset
- Approves/denies delegates' speaking request
- System supports up to 100 chairman units, while all or part chairman units have the control facilities listed above (set by software or main unit)

Controls and Indicators

- 4.3" touch screen for displaying:
 - ◆ Speaking list, timing speaking information, delegate information
 - ◆ Language channel and earphone volume adjustment
 - ◆ Screen brightness, system language and unit information
- Built-in channel selector with channel selection function
- Uni-directional electret condenser microphone with bi-color illuminated ring
- Headphones volume control
- Microphone On/Off button with indicator
- Priority button

Interconnections

- Socket for pluggable microphone
- Ø 3.5 mm stereo headphone jack
- 1.5 m cable with 8P-DIN plug
- 0.6 m cable with 8P-DIN socket

Technical Specifications

Electrical

Max. consumption.....3.6 W

Headphone connection

Frequency response.....20 Hz to 20 kHz

Earphone load impedance.....>16 Ohm

Earphone output.....10 mW

LCD

Dimension.....4:3

Resolution.....800×480

Contrast.....800:1

Recommended microphone type

Transducer.....Electret-condenser

Polar pattern.....Uni-directional

Operating voltage.....5 VDC

Sensitivity.....-46 dBV/Pa

Frequency response.....50 Hz to 20 kHz

Input impedance.....2 kOhm

Directivity 0°/180°.....> 20 dB (1 kHz)

Equivalent noise.....20 dBA (SPL)

Maximum sound pressure level.....125 dB (THD<3%)

Interface data

Connector.....Ø 3.5 mm stereo jack for headphone

Mechanical

Mounting.....Tabletop

Dimensions (h x w x d) (w/o stem microphone).....60 x 240 x 101 mm

Weight (incl. stem microphone).....1.1 kg

Color.....Black (PANTONE 419 C)

Stem length.....330 mm, 410 mm (standard version), 470 mm

Ordering Information

HCS-4890NCS_B/80.....Fully Digital Congress System Chairman Unit (tabletop, discussion, 64 CHs, 4.3" touch screen, Braille, black)

HCS-4890NDS/80 Delegate Unit with Channel Selection



Features

- **Elegant and ergonomic design**
- **Exquisite and delicate tabletop design for ease of use and transport**
- **Cable coming out of the base for a tidier wiring**
- **Hi-Fi loudspeaker**
- **Pluggable microphone**
- **Exquisite and sleek 4.3" touch screen for information display of meeting proceedings**
- **Supports custom boot screen and background picture**
- **"Closed Loop - Daisy Chain" connection topology**
- **Intuitive language list and volume control for quick channel switch and volume adjustment on the screen**
- **Transmitting up to 64 CHs high quality digital audio signals on a dedicated 8-pin cable**
- **Supporting 48 kHz audio sampling rate, all 64 channels perfectly reproducing audio frequencies between 20 Hz and 20 kHz**
- **Excellent immunity to RF interference from mobile phones**
- **Separate adjustment of gain and EQ (5 band) of each microphone for the perfect sound**
- **Supporting "PnP" (plug and play)**

The multi-functional delegate unit meets the demands of even the largest conferences. It provides facilities for speaking, registering a request-to-speak, listening, selecting language channels. Excellent immunity to RF interference from mobile phones. A 4.3" touch screen can display speaking list, channel number and language name, operation menu, etc. Channel selection is automatically limited to the number of language channels available.

The loudspeaker offers superior acoustics with minimal feedback for enhanced intelligibility.

Functions

- Compliant to ISO 22259
- "Closed Loop - Daisy Chain" connection topology for a high operational system reliability: breakdown or replacement of a congress unit and connection failure of a cable will not influence other congress units
- Based on TAIDEN originated MCA-STREAM digital audio processing and transmitting technologies
- Proprietary MCA-STREAM technology used to transmit fully digital audio between the congress units as well as between congress units and main unit(s)
- Audio signals processed by high performance DSP: sound quality approaching CD quality
- Gain and EQ (5 band) of each microphone adjustable separately, fitting the individual orator's voice to achieve perfect speech pickup any time
- Transmitting up to 64 CHs high quality digital audio signals on a dedicated 8-pin cable (general cat5e cable with a drain wire substitutable)
- Supports up to 64 (1+63) CHs simultaneous interpretation
- Supports 48 kHz audio sampling, and all 64 channels perfectly reproducing audio frequencies between 20 Hz and 20 kHz
- Intuitive language list and volume control for quick channel switch and volume adjustment on the screen
- Integrated high-pass filter (low-cut switch) to cut low frequency elements from the audio when needed
- Automatic system recovery and "PnP" (plug and play)
- Stem microphone can be unplugged during adjournment, easy to maintain
- Mini-microphone, with foam windshield
- Hi-Fi loudspeaker, minimal feedback, mutes automatically when microphone is active
- Excellent immunity to RF interference from mobile phones and comparable devices
- Microphone On/Off button
- Hand up button (discussion mode)
- An ID can be assigned by default or manually to each conference unit bearing a unique serial number for convenient maintenance
- Facilities in independent operation from computer:
 - ◆ Set the number of delegates permitted to speak at the same time
 - ◆ Speak mode: Open/Override/Voice/Request/PTT
 - "Open" mode, microphone On/Off button with request-to-speak registration (AUTO)
 - "Override" mode, microphone On/Off button control with override of the active microphones (FIFO)
 - "Voice" mode, acoustic active sensitivity and automatic switch-off time adjustable continuously, built-in "flash-on" technology, immediate microphone activation on speaking
 - "Request" mode, delegate requests to speak by pressing microphone On/Off button, delegate only speaks when operator or chairman approved his application
 - "PTT" mode, press microphone On/Off button to talk
 - ◆ Simultaneous interpretation
- Braille is present for all physical buttons
- Automatic video tracking implementation when cooperating with cameras & video switcher unit; preset positions on PC

- Set any delegate unit to be VIP unit
 - ◆ Up to 32 units can be set as VIP in one system via application software
 - ◆ VIP unit can be activated as long as the total of active microphones is not beyond 8 (incl. chairman/delegate/VIP unit)

Controls and Indicators

- 4.3" touch screen for displaying:
 - ◆ Speaking list, timing speaking information, delegate information
 - ◆ Language channel and earphone volume adjustment
 - ◆ Screen brightness, system language and unit information
- Built-in channel selector with channel selection function
- Uni-directional electret condenser microphone with bi-color illuminated ring
- Headphones volume control
- Microphone On/Off button with indicator

Interconnections

- Socket for pluggable microphone
- Ø 3.5 mm stereo headphone jack
- 1.5 m cable with 8P-DIN plug
- 0.6 m cable with 8P-DIN socket

Technical Specifications

Electrical

Max. consumption.....3.6 W

Headphone connection

Frequency response.....20 Hz to 20 kHz

Earphone load impedance.....>16 Ohm

Earphone output.....10 mW

LCD

Dimension.....4:3

Resolution.....800×480

Contrast.....800:1

Recommended microphone type

Transducer.....Electret-condenser

Polar pattern.....Uni-directional

Operating voltage.....5 VDC

Sensitivity.....-46 dBV/Pa

Frequency response.....50 Hz to 20 kHz

Input impedance.....2 kOhm

Directivity 0°/180°.....> 20 dB (1 kHz)

Equivalent noise.....20 dBA (SPL)

Maximum sound pressure level.....125 dB (THD<3%)

Interface data

Connector.....Ø 3.5 mm stereo jack for headphone

Mechanical

Mounting.....Tabletop

Dimensions (h x w x d) (w/o stem microphone)...60 x 240 x 101 mm

Weight (incl. stem microphone).....1.1 kg

Color.....Black (PANTONE 419 C)

Stem length.....330 mm, 410 mm (standard version), 470 mm

Ordering Information

HCS-4890NDS_B/80.....Fully Digital Congress System Delegate Unit (tabletop, discussion, 64 CHs, 4.3" touch screen, Braille, black)

HCS-4890NCVSE/FM/80 Chairman Unit with Voting and Channel Selection



Features

- Flush-mounting, elegant and ergonomic design
- Hi-Fi loudspeaker
- Priority button
- Pluggable microphone
- 5 voting keys
- Exquisite and sleek 4.3" touch screen for information display of meeting proceedings
- Supports custom boot screen and background picture
- "Closed Loop - Daisy Chain" connection topology
- Intuitive language list and volume control for quick channel switch and volume adjustment on the screen
- Transmitting up to 64 CHs high quality digital audio signals on a dedicated cable
- Supporting 48 kHz audio sampling rate, all 64 channels perfectly reproducing audio frequencies between 20 Hz and 20 kHz
- Excellent immunity to RF interference from mobile phones
- Separate adjustment of gain and EQ (5 band) of each microphone for the perfect sound
- Supporting "PnP" (plug and play)
- Built-in contactless IC-Card reader

The stylish and ergonomically designed chairman unit has all the necessary facilities to enable the user to chair a conference. It has excellent immunity to RF interference from mobile phones. Similar in appearance to HCS-4890NDVSE/FM/80 Delegate Unit, the HCS-4890NCVSE/FM/80 Chairman Unit includes a microphone priority button. When pressed, the priority button causes all currently active delegate microphones to be switched off temporarily or permanently, allowing the chairman to take control of the meeting. A 4.3" touch screen can display speaking list, sign-in and voting information, channel number and language name, operation menu, etc. Channel selection is automatically limited to the number of language channels available.

The loudspeaker offers superior acoustics with minimal feedback for enhanced intelligibility.

Functions

- Compliant to ISO 22259
- "Closed Loop - Daisy Chain" connection topology for a high operational system reliability: breakdown or replacement of a congress unit and connection failure of a cable will not influence other congress units
- Based on TAIDEN originated MCA-STREAM digital audio processing and transmitting technologies
- Proprietary MCA-STREAM technology used to transmit fully digital audio between the congress units as well as between congress units and main unit(s)
- Audio signals processed by high performance DSP: sound quality approaching CD quality
- Gain and EQ (5 band) of each microphone adjustable separately, fitting the individual orator's voice to achieve perfect speech pickup any time
- Transmitting up to 64 CHs high quality digital audio signals on a dedicated cable (recommended use of cat5e cable with a drain wire)
- Supports up to 64 (1+63) CHs simultaneous interpretation
- Supports 48 kHz audio sampling, and all 64 channels perfectly reproducing audio frequencies between 20 Hz and 20 kHz
- Intuitive language list and volume control for quick channel switch and volume adjustment on the screen
- Integrated high-pass filter (low-cut switch) to cut low frequency elements from the audio when needed
- Automatic system recovery and "PnP" (plug and play)
- Stem microphone can be unplugged during adjournment, easy to maintain
- Mini-microphone, built-in foam windshield
- Hi-Fi loudspeaker, minimal feedback, mutes automatically when microphone is active
- Excellent immunity to RF interference from mobile phones and comparable devices
- Microphone On/Off button, 5 voting keys
- An ID can be assigned by default or manually to each conference unit bearing a unique serial number for convenient maintenance
- Facilities in independent operation from computer:
 - ◆ Set the number of delegates permitted to speak at the same time
 - ◆ Speak mode: Open/Override/Voice/Request/PTT
 - "Open" mode, microphone On/Off button with request-to-speak registration (AUTO)
 - "Override" mode, microphone On/Off button control with override of the active microphones (FIFO)
 - "Voice" mode, acoustic active sensitivity and automatic switch-off time adjustable continuously, built-in "flash-on" technology, immediate microphone activation on speaking
 - "Request" mode, delegate requests to speak by pressing microphone On/Off button, delegate only speaks when operator or chairman approved his application
 - "PTT" mode, press microphone On/Off button to talk
 - ◆ Simultaneous interpretation
- Multiform voting function can be implemented in combination with the corresponding software
- Key-press sign-in, contactless IC-Card sign-in

- Built-in contactless IC-Card slot to place the IC card, while automatically logout once the card is taken out from the slot
- Automatic video tracking implementation when cooperating with cameras & video switcher unit; preset positions on PC
- Activation at any time (if the amount of active microphones in the system is less than 8)
- Priority button to switch off or to mute the delegate units (except VIP units) according to preset
- Approves/denies delegates' speaking request
- System supports up to 100 chairman units, while all or part chairman units have the control facilities listed above (set by software or main unit)

Controls and Indicators

- 4.3" touch screen for displaying:
 - ◆ Speaking list, timing speaking information, delegate information
 - ◆ Sign-in and voting information
 - ◆ Language channel and earphone volume adjustment
 - ◆ Screen brightness, system language and unit information
- Built-in channel selector with channel selection function
- Uni-directional electret condenser microphone with bi-color illuminated ring
- Headphones volume control
- Five voting keys
- Microphone On/Off button with indicator
- Priority button

Interconnections

- Socket for pluggable microphone
- Ø 3.5 mm stereo headphone jack
- Contactless IC-Card slot
- 1.5 m cable with 8P-DIN plug
- 0.6 m cable with 8P-DIN socket

Technical Specifications

Electrical

Max. consumption.....3.6 W

Headphone connection

Frequency response.....20 Hz to 20 kHz

Earphone load impedance.....>16 Ohm

Earphone output.....10 mW

LCD

Dimension.....4:3

Resolution.....800×480

Contrast.....800:1

Recommended microphone type

Transducer.....Electret-condenser

Polar pattern.....Uni-directional

Operating voltage.....5 VDC

Sensitivity.....-46 dBV/Pa

Frequency response.....50 Hz to 20 kHz

Input impedance.....2 kOhm

Directivity 0°/180°.....> 20 dB (1 kHz)

Equivalent noise.....20 dBA (SPL)

Maximum sound pressure level.....125 dB (THD<3%)

Interface data

Connector.....Ø 3.5 mm stereo jack for headphone

Mechanical

Mounting.....Flush-mounting

Dimensions (h x w x d) (w/o stem microphone).....90 x 240 x 112 mm

Weight (incl. stem microphone).....0.9 kg

Color.....Black (PANTONE 419 C)

Stem length.....330 mm, 410 mm (standard version), 470 mm

Ordering Information

HCS-4890NCVSE/FM_B/80...Fully Digital Congress System
 Chairman Unit (flush-mounting, discussion, 5 voting keys, built-in contactless IC-Card slot, 64 CHs, 4.3" touch screen, black)

HCS-4890NDVSE/FM/80 Delegate Unit with Voting and Channel Selection



Features

- **Elegant and ergonomic design**
- **Hi-Fi loudspeaker**
- **Pluggable microphone**
- **5 voting keys**
- **Exquisite and sleek 4.3" touch screen for information display of meeting proceedings**
- **Supports custom boot screen and background picture**
- **"Closed Loop - Daisy Chain" connection topology**
- **Intuitive language list and volume control for quick channel switch and volume adjustment on the screen**
- **Transmitting up to 64 CHs high quality digital audio signals on a dedicated cable**
- **Supporting 48 kHz audio sampling rate, all 64 channels perfectly reproducing audio frequencies between 20 Hz and 20 kHz**
- **Excellent immunity to RF interference from mobile phones**
- **Separate adjustment of gain and EQ (5 band) of each microphone for the perfect sound**
- **Supporting "PnP" (plug and play)**
- **Built-in contactless IC-Card reader**

The multi-functional delegate unit meets the demands of even the largest conferences. It provides facilities for speaking, registering a request-to-speak, listening, voting, selecting language channels and IC-Card sign-in. Excellent immunity to RF interference from mobile phones. A 4.3" touch screen can display speaking list, sign-in and voting information, channel number and language name, operation menu, etc. Channel selection is automatically limited to the number of language channels available.

The loudspeaker offers superior acoustics with minimal feedback for enhanced intelligibility.

Functions

- Compliant to ISO 22259
- "Closed Loop - Daisy Chain" connection topology for a high operational system reliability: breakdown or replacement of a congress unit and connection failure of a cable will not influence other congress units
- Based on TAIDEN originated MCA-STREAM digital audio processing and transmitting technologies
- Proprietary MCA-STREAM technology used to transmit fully digital audio between the congress units as well as between congress units and main unit(s)
- Audio signals processed by high performance DSP: sound quality approaching CD quality
- Gain and EQ (5 band) of each microphone adjustable separately, fitting the individual orator's voice to achieve perfect speech pickup any time
- Transmitting up to 64 CHs high quality digital audio signals on a dedicated cable (recommended use of cat5e cable with a drain wire)
- Supports up to 64 (1+63) CHs simultaneous interpretation
- Supports 48 kHz audio sampling, and all 64 channels perfectly reproducing audio frequencies between 20 Hz and 20 kHz
- Intuitive language list and volume control for quick channel switch and volume adjustment on the screen
- Integrated high-pass filter (low-cut switch) to cut low frequency elements from the audio when needed
- Automatic system recovery and "PnP" (plug and play)
- Stem microphone can be unplugged during adjournment, easy to maintain
- Mini-microphone, built-in foam windshield
- Hi-Fi loudspeaker, minimal feedback, mutes automatically when microphone is active
- Excellent immunity to RF interference from mobile phones and comparable devices
- Microphone On/Off button, 5 voting keys
- An ID can be assigned by default or manually to each conference unit bearing a unique serial number for convenient maintenance
- Facilities in independent operation from computer:
 - ◆ Set the number of delegates permitted to speak at the same time
 - ◆ Speak mode: Open/Override/Voice/Request/PTT
 - "Open" mode, microphone On/Off button with request-to-speak registration (AUTO)
 - "Override" mode, microphone On/Off button control with override of the active microphones (FIFO)
 - "Voice" mode, acoustic active sensitivity and automatic switch-off time adjustable continuously, built-in "flash-on" technology, immediate microphone activation on speaking
 - "Request" mode, delegate requests to speak by pressing microphone On/Off button, delegate only speaks when operator or chairman approved his application
 - "PTT" mode, press microphone On/Off button to talk
 - ◆ Simultaneous interpretation
- Multifunction voting function can be implemented in combination with the corresponding software
- Key-press sign-in, contactless IC-Card sign-in

- Built-in contactless IC-Card slot to place the IC card, while automatically logout once the card is taken out from the slot
- Automatic video tracking implementation when cooperating with cameras & video switcher unit; preset positions on PC
- Set any delegate unit to be VIP unit
 - ◆ Up to 32 units can be set as VIP in one system via application software
 - ◆ VIP unit can be activated as long as the total of active microphones is not beyond 8 (incl. chairman/delegate/VIP unit)

Controls and Indicators

- 4.3" touch screen for displaying:
 - ◆ Speaking list, timing speaking information, delegate information
 - ◆ Sign-in and voting information
 - ◆ Language channel and earphone volume adjustment
 - ◆ Screen brightness, system language and unit information
- Built-in channel selector with channel selection function
- Uni-directional electret condenser microphone with bi-color illuminated ring
- Headphones volume control
- Five voting keys
- Microphone On/Off button with indicator

Interconnections

- Socket for pluggable microphone
- Ø 3.5 mm stereo headphone jack
- Contactless IC-Card slot
- 1.5 m cable with 8P-DIN plug
- 0.6 m cable with 8P-DIN socket

Technical Specifications

Electrical

Max. consumption.....3.6 W

Headphone connection

Frequency response.....20 Hz to 20 kHz

Earphone load impedance.....>16 Ohm

Earphone output.....10 mW

LCD

Dimension.....4:3

Resolution.....800×480

Contrast.....800:1

Recommended microphone type

Transducer.....Electret-condenser

Polar pattern.....Uni-directional

Operating voltage.....5 VDC

Sensitivity.....-46 dBV/Pa

Frequency response.....50 Hz to 20 kHz

Input impedance.....2 kOhm

Directivity 0°/180°.....> 20 dB (1 kHz)

Equivalent noise.....20 dBA (SPL)

Maximum sound pressure level.....125 dB (THD<3%)

Interface data

Connector.....Ø 3.5 mm stereo jack for headphone

Mechanical

Mounting.....Flush-mounting

Dimensions (h x w x d) (w/o stem microphone).....90 x 240 x 112 mm

Weight (incl. stem microphone).....0.9 kg

Color.....Black (PANTONE 419 C)

Stem length.....330 mm, 410 mm (standard version), 470 mm

Ordering Information

HCS-4890NDVSE/FM_B/80.....Fully Digital Congress System
 Delegate Unit (flush-mounting, discussion, 5 voting keys, built-in contactless IC-Card slot, 64 CHs, 4.3" touch screen, black)

User interface

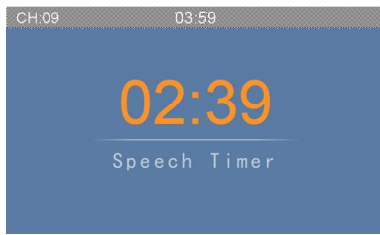

Timing speaking

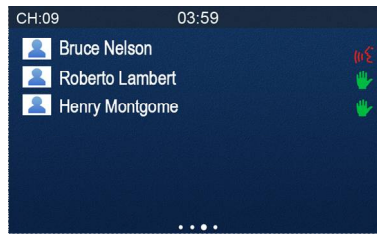

Speaking list

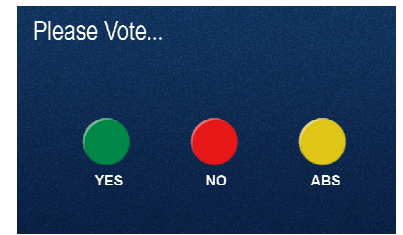

Voting

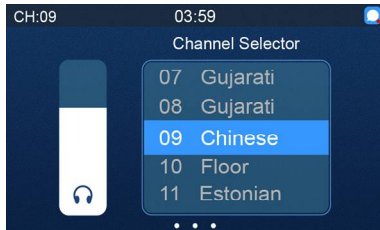

Simultaneous interpretation

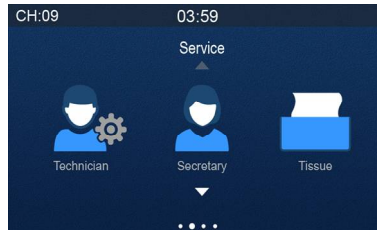

Service

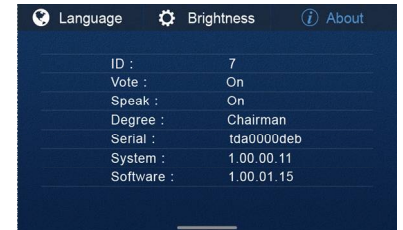

About

Function list

Model No.	Type	Speech	Voting	SI	4.3" touch screen	IC card	Speaker	Main unit	Cable
HCS-4890NCVS/80	Chairman	√	5-key	64CHs	√	√	√	HCS-4800MA/20	8-pin dedicated cable
HCS-4890NDVS/80	Delegate	√	5-key	64CHs	√	√	√		
HCS-4890NCS/80	Chairman	√		64CHs	√		√		
HCS-4890NDS/80	Delegate	√		64CHs	√		√		
HCS-4890NCVSE/FM/80	Chairman	√	5-key	64CHs	√	√	√		
HCS-4890NDVSE/FM/80	Delegate	√	5-key	64CHs	√	√	√		

HCS-4891CVS/80 Chairman Unit with Voting and Channel Selection



Features

- Elegant and ergonomic design
- Exquisite and delicate tabletop design for ease of use and transport
- Cable coming out of the base for a tidier wiring
- Priority button
- Pluggable microphone
- 5-key voting
- Exquisite and sleek 4.3" touch screen for information display of meeting proceedings
- Supports custom boot screen and background picture
- "Closed Loop - Daisy Chain" connection topology
- 64 CHs×2 interpretation with independent volume control. Two delegates may share one unit thus cutting the facility cost by half
- Transmitting up to 64 CHs high quality digital audio signals on a dedicated 8-pin cable
- Supporting 48 kHz audio sampling rate, all 64 channels perfectly reproducing audio frequencies between 20 Hz and 20 kHz
- Water resistant and noise-free button with long service life
- Excellent immunity to RF interference from mobile phones
- Separate adjustment of gain and EQ (5 band) of each microphone for the perfect sound
- Supporting "PnP" (plug and play)

The stylish and ergonomically designed chairman unit has all the necessary facilities to enable the user to chair a conference. It has excellent immunity to RF interference from mobile phones. Similar in appearance to HCS-4891DVS/80 Delegate Unit, the HCS-4891CVS/80 Chairman Unit includes a microphone priority button. When pressed, the priority button causes all currently active delegate microphones to be switched off temporarily or permanently, allowing the chairman to take control of the meeting. A 4.3" touch screen can display speaking list, sign-in and voting information, channel number and language name, operation menu, etc. Channel selection is automatically limited to the number of language channels available.

Functions

- "Closed Loop - Daisy Chain" connection topology for a high operational system reliability: breakdown or replacement of a congress unit and connection failure of a cable will not influence other congress units
- Based on TAIDEN originated MCA-STREAM digital audio processing and transmitting technologies
- Proprietary MCA-STREAM technology used to transmit fully digital audio between the congress units as well as between congress units and main unit(s)
- Audio signals processed by high performance DSP: sound quality approaching CD quality
- Gain and EQ (5 band) of each microphone adjustable separately, fitting the individual orator's voice to achieve perfect speech pickup any time
- Transmitting up to 64 CHs high quality digital audio signals on a dedicated 8-pin cable (general cat5e cable with a drain wire substitutable)
- Supports up to 64 (1+63) CHs simultaneous interpretation
- Supports 48 kHz audio sampling, and all 64 channels perfectly reproducing audio frequencies between 20 Hz and 20 kHz
- 64 CHs×2 interpretation with volume control. Two delegates may share one unit thus cutting the cost by half (earphone needed)
- Integrated high-pass filter (low-cut switch) to cut low frequency elements from the audio when needed
- Automatic system recovery and "PnP" (plug and play)
- Stem microphone can be unplugged during adjournment, easy to maintain
- Mini-microphone, built-in foam windshield
- Excellent immunity to RF interference from mobile phones and comparable devices
- Microphone On/Off button, 5-key voting
- Hand up button (discussion mode)
- An ID can be assigned by default or manually to each conference unit bearing a unique serial number for convenient maintenance
- Facilities in independent operation from computer:
 - ◆ Set the number of delegates permitted to speak at the same time
 - ◆ Speak mode: Open/Override/Voice/Request/PTT
 - "Open" mode, microphone On/Off button with request-to-speak registration (AUTO)
 - "Override" mode, microphone On/Off button control with override of the active microphones (FIFO)
 - "Voice" mode, acoustic active sensitivity and automatic switch-off time adjustable continuously, built-in "flash-on" technology, immediate microphone activation on speaking
 - "Request" mode, delegate requests to speak by pressing microphone On/Off button, delegate only speaks when operator or chairman approved his application
 - "PTT" mode, press microphone On/Off button to talk
 - ◆ Simultaneous interpretation
- Multifunction voting function can be implemented in combination with the corresponding software
- Key-press sign-in
- Automatic video tracking implementation when cooperating with cameras & video switcher unit; preset positions on PC

- Activation at any time (if the amount of active microphones in the system is less than 8)
- Priority button to switch off or to mute the delegate units (except VIP units) according to preset
- Approves/denies delegates' speaking request
- System supports up to 100 chairman units, while all or part chairman units have the control facilities listed above (set by software or main unit)

Color.....Black (PANTONE 419 C)
 Stem length.....330 mm, 410 mm (standard version), 470 mm

Controls and Indicators

- 4.3" touch screen for displaying:
 - ◆ Speaking list, timing speaking information, delegate information
 - ◆ Sign-in and voting information
 - ◆ Language channel and earphone volume adjustment
 - ◆ Screen brightness, system language and unit information
- Built-in channel selector with channel selection function
- Uni-directional electret condenser microphone with bi-color illuminated ring
- Headphones volume control
- Five virtual voting buttons
- Microphone On/Off button with indicator
- Priority button

Interconnections

- Socket for pluggable microphone
- 2×Ø 3.5 mm stereo headphone jacks
- 1.5 m cable with 8P-DIN plug
- 0.6 m cable with 8P-DIN socket

Technical Specifications

Electrical

Max. consumption.....2.4 W

LCD

Dimension.....4:3

Resolution.....800×480

Contrast.....800:1

Headphone connection

Frequency response.....20 Hz to 20 kHz

Earphone load impedance.....>16 Ohm

Earphone output.....10 mW

Recommended microphone type

Transducer.....Electret-condenser

Polar pattern.....Uni-directional

Operating voltage.....5 VDC

Sensitivity.....-46 dBV/Pa

Frequency response.....50 Hz to 20 kHz

Input impedance.....2 kOhm

Directivity 0°/180°.....> 20 dB (1 kHz)

Equivalent noise.....20 dBA (SPL)

Maximum sound pressure level.....125 dB (THD<3%)

Interface data

Connector.....2×Ø 3.5 mm stereo jacks for headphones

Mechanical

Mounting.....Tabletop

Dimensions (h x w x d) (w/o stem microphone).....68 x 99 x 145 mm

Weight (incl. stem microphone).....1.0 kg

Ordering Information

HCS-4891CVS_B/80.....Fully Digital Congress System Chairman Unit (tabletop, discussion, 5-key voting, 64 CHs×2, 4.3" touch screen, black)

HCS-4891DVS/80 Delegate Unit with Voting and Channel Selection



Features

- Elegant and ergonomic design
- Exquisite and delicate tabletop design for ease of use and transport
- Cable coming out of the base for a tidier wiring
- Pluggable microphone
- 5-key voting
- Exquisite and sleek 4.3" touch screen for information display of meeting proceedings
- Supports custom boot screen and background picture
- "Closed Loop - Daisy Chain" connection topology
- 64 CHs×2 interpretation with independent volume control. Two delegates may share one unit thus cutting the facility cost by half
- Transmitting up to 64 CHs high quality digital audio signals on a dedicated 8-pin cable
- Supporting 48 kHz audio sampling rate, all 64 channels perfectly reproducing audio frequencies between 20 Hz and 20 kHz
- Water resistant and noise-free button with long service life
- Excellent immunity to RF interference from mobile phones
- Separate adjustment of gain and EQ (5 band) of each microphone for the perfect sound
- Supporting "PnP" (plug and play)

The multi-functional delegate unit meets the demands of even the largest conferences. It provides facilities for speaking, registering a request-to-speak, listening, voting, selecting language channels and IC-Card sign-in. Excellent immunity to RF interference from mobile phones. A 4.3" touch screen can display speaking list, sign-in and voting information, channel number and language name, operation menu, etc. Channel selection is automatically limited to the number of language channels available.

Functions

- "Closed Loop - Daisy Chain" connection topology for a high operational system reliability: breakdown or replacement of a congress unit and connection failure of a cable will not influence other congress units
- Based on TAIDEN originated MCA-STREAM digital audio processing and transmitting technologies
- Proprietary MCA-STREAM technology used to transmit fully digital audio between the congress units as well as between congress units and main unit(s)
- Audio signals processed by high performance DSP: sound quality approaching CD quality
- Gain and EQ (5 band) of each microphone adjustable separately, fitting the individual orator's voice to achieve perfect speech pickup any time
- Transmitting up to 64 CHs high quality digital audio signals on a dedicated 8-pin cable (general cat5e cable with a drain wire substitutable)
- Supports up to 64 (1+63) CHs simultaneous interpretation
- Supports 48 kHz audio sampling, and all 64 channels perfectly reproducing audio frequencies between 20 Hz and 20 kHz
- 64 CHs×2 interpretation with volume control. Two delegates may share one unit thus cutting the cost by half (earphone needed)
- Integrated high-pass filter (low-cut switch) to cut low frequency elements from the audio when needed
- Automatic system recovery and "PnP" (plug and play)
- Stem microphone can be unplugged during adjournment, easy to maintain
- Mini-microphone, built-in foam windshield
- Excellent immunity to RF interference from mobile phones and comparable devices
- Microphone On/Off button, 3 voting keys
- Hand up button (discussion mode)
- An ID can be assigned by default or manually to each conference unit bearing a unique serial number for convenient maintenance
- Facilities in independent operation from computer:
 - ◆ Set the number of delegates permitted to speak at the same time
 - ◆ Speak mode: Open/Override/Voice/Request/PTT
 - "Open" mode, microphone On/Off button with request-to-speak registration (AUTO)
 - "Override" mode, microphone On/Off button control with override of the active microphones (FIFO)
 - "Voice" mode, acoustic active sensitivity and automatic switch-off time adjustable continuously, built-in "flash-on" technology, immediate microphone activation on speaking
 - "Request" mode, delegate requests to speak by pressing microphone On/Off button, delegate only speaks when operator or chairman approved his application
 - "PTT" mode, press microphone On/Off button to talk
 - ◆ Simultaneous interpretation
- Multifunction voting function can be implemented in combination with the corresponding software
- Key-press sign-in
- Automatic video tracking implementation when cooperating with cameras & video switcher unit; preset positions on PC

- Set any delegate unit to be VIP unit
 - ◆ Up to 32 units can be set as VIP in one system via application software
 - ◆ VIP unit can be activated as long as the total of active microphones is not beyond 8 (incl. chairman/delegate/VIP unit)

Controls and Indicators

- 4.3" touch screen for displaying:
 - ◆ Speaking list, timing speaking information, delegate information
 - ◆ Sign-in and voting information
 - ◆ Language channel and earphone volume adjustment
 - ◆ Screen brightness, system language and unit information
- Built-in channel selector with channel selection function
- Uni-directional electret condenser microphone with bi-color illuminated ring
- Headphones volume control
- Five virtual voting buttons
- Microphone On/Off button with indicator

Interconnections

- Socket for pluggable microphone
- 2×Ø 3.5 mm stereo headphone jacks
- 1.5 m cable with 8P-DIN plug
- 0.6 m cable with 8P-DIN socket

Technical Specifications

Electrical

Max. consumption.....2.4 W

LCD

Dimension.....4:3

Resolution.....800×480

Contrast.....800:1

Headphone connection

Frequency response.....20 Hz to 20 kHz

Earphone load impedance.....>16 Ohm

Earphone output.....10 mW

Recommended microphone type

Transducer.....Electret-condenser

Polar pattern.....Uni-directional

Operating voltage.....5 VDC

Sensitivity.....-46 dBV/Pa

Frequency response.....50 Hz to 20 kHz

Input impedance.....2 kOhm

Directivity 0°/180°.....> 20 dB (1 kHz)

Equivalent noise.....20 dBA (SPL)

Maximum sound pressure level.....125 dB (THD<3%)

Interface data

Connector.....2×Ø 3.5 mm stereo jacks for headphones

Mechanical

Mounting.....Tabletop

Dimensions (h x w x d) (w/o stem microphone).....68 x 99 x 145 mm

Weight (incl. stem microphone).....1.0 kg

Color.....Black (PANTONE 419 C)

Stem length.....330 mm, 410 mm (standard version), 470 mm

Ordering Information

HCS-4891DVS_B/80.....Fully Digital Congress System Delegate Unit (tabletop, discussion, 5-key voting, 64 CHs×2, 4.3" touch screen, black)

HCS-4891C/80 Chairman Unit



Features

- **Elegant and ergonomic design**
- **Exquisite and delicate tabletop design for ease of use and transport**
- **Cable coming out of the base for a tidier wiring**
- **Priority button**
- **Pluggable microphone**
- **Exquisite and sleek 4.3" touch screen for information display of meeting proceedings**
- **Supports custom boot screen and background picture**
- **"Closed Loop - Daisy Chain" connection topology**
- **Supporting 48 kHz audio sampling rate**
- **Water resistant and noise-free button with long service life**
- **Excellent immunity to RF interference from mobile phones**
- **Separate adjustment of gain and EQ (5 band) of each microphone for the perfect sound**
- **Supporting "PnP" (plug and play)**

The stylish and ergonomically designed chairman unit has all the necessary facilities to enable the user to chair a conference. It has excellent immunity to RF interference from mobile phones. Similar in appearance to HCS-4891D/80 Delegate Unit, the HCS-4891C/80 Chairman Unit includes a microphone priority button. When pressed, the priority button causes all currently active delegate microphones to be switched off temporarily or permanently, allowing the chairman to take control of the meeting. A 4.3" touch screen can display speaking list, operation menu, etc.

Functions

- "Closed Loop - Daisy Chain" connection topology for a high operational system reliability: breakdown or replacement of a congress unit and connection failure of a cable will not influence other congress units
- Based on TAIDEN originated MCA-STREAM digital audio processing and transmitting technologies
- Proprietary MCA-STREAM technology used to transmit fully digital audio between the congress units as well as between congress units and main unit(s)
- Audio signals processed by high performance DSP: sound quality approaching CD quality

- Gain and EQ (5 band) of each microphone adjustable separately, fitting the individual orator's voice to achieve perfect speech pickup any time
- Supporting 48 kHz audio sampling rate
- Integrated high-pass filter (low-cut switch) to cut low frequency elements from the audio when needed
- Automatic system recovery and "PnP" (plug and play)
- Stem microphone can be unplugged during adjournment, easy to maintain
- Mini-microphone, built-in foam windshield
- Excellent immunity to RF interference from mobile phones and comparable devices
- Microphone On/Off button
- Hand up button (discussion mode)
- An ID can be assigned by default or manually to each conference unit bearing a unique serial number for convenient maintenance
- Facilities in independent operation from computer:
 - ◆ Set the number of delegates permitted to speak at the same time
 - ◆ Speak mode: Open/Override/Voice/Request/PTT
 - "Open" mode, microphone On/Off button with request-to-speak registration (AUTO)
 - "Override" mode, microphone On/Off button control with override of the active microphones (FIFO)
 - "Voice" mode, acoustic active sensitivity and automatic switch-off time adjustable continuously, built-in "flash-on" technology, immediate microphone activation on speaking
 - "Request" mode, delegate requests to speak by pressing microphone On/Off button, delegate only speaks when operator or chairman approved his application
 - "PTT" mode, press microphone On/Off button to talk
- Automatic video tracking implementation when cooperating with cameras & video switcher unit; preset positions on PC
- Activation at any time (if the amount of active microphones in the system is less than 8)
- Priority button to switch off or to mute the delegate units (except VIP units) according to preset
- Approves/denies delegates' speaking request
- System supports up to 100 chairman units, while all or part chairman units have the control facilities listed above (set by software or main unit)

Controls and Indicators

- 4.3" touch screen for displaying:
 - ◆ Speaking list, timing speaking information, delegate information
 - ◆ Screen brightness, system language and unit information
- Uni-directional electret condenser microphone with bi-color illuminated ring
- Headphones volume control
- Microphone On/Off button with indicator
- Priority button

Interconnections

- Socket for pluggable microphone
- 2×Ø 3.5 mm stereo headphone jacks
- 1.5 m cable with 8P-DIN plug
- 0.6 m cable with 8P-DIN socket

Technical Specifications

Electrical

Max. consumption.....2.4 W

LCD

Dimension.....4:3

Resolution.....800×480

Contrast.....800:1

Headphone connection

Frequency response.....20 Hz to 20 kHz

Earphone load impedance.....>16 Ohm

Earphone output.....10 mW

Recommended microphone type

Transducer.....Electret-condenser

Polar pattern.....Uni-directional

Operating voltage.....5 VDC

Sensitivity.....-46 dBV/Pa

Frequency response.....50 Hz to 20 kHz

Input impedance.....2 kOhm

Directivity 0°/180°.....> 20 dB (1 kHz)

Equivalent noise.....20 dBA (SPL)

Maximum sound pressure level.....125 dB (THD<3%)

Interface data

Connector.....2×Ø 3.5 mm stereo jacks for headphones

Mechanical

Mounting.....Tabletop

Dimensions (h x w x d) (w/o stem microphone).....68 x 99 x 145 mm

Weight (incl. stem microphone).....1.0 kg

Color.....Black (PANTONE 419 C)

Stem length.....330 mm, 410 mm (standard version), 470 mm

Ordering Information

HCS-4891C_B/80.....Fully Digital Congress System Chairman
Unit (tabletop, discussion, 4.3" touch
screen, black)

HCS-4891D/80 Delegate Unit



Features

- **Elegant and ergonomic design**
- **Exquisite and delicate tabletop design for ease of use and transport**
- **Cable coming out of the base for a tidier wiring**
- **Pluggable microphone**
- **Exquisite and sleek 4.3" touch screen for information display of meeting proceedings**
- **Supports custom boot screen and background picture**
- **"Closed Loop - Daisy Chain" connection topology**
- **Supporting 48 kHz audio sampling rate**
- **Water resistant and noise-free button with long service life**
- **Excellent immunity to RF interference from mobile phones**
- **Separate adjustment of gain and EQ (5 band) of each microphone for the perfect sound**
- **Supporting "PnP" (plug and play)**

The multi-functional delegate unit meets the demands of even the largest conferences. It provides facilities for speaking, registering a request-to-speak, listening. Excellent immunity to RF interference from mobile phones. A 4.3" touch screen can display speaking list, operation menu, etc.

Functions

- "Closed Loop - Daisy Chain" connection topology for a high operational system reliability: breakdown or replacement of a congress unit and connection failure of a cable will not influence other congress units
- Based on TAIDEN originated MCA-STREAM digital audio processing and transmitting technologies
- Proprietary MCA-STREAM technology used to transmit fully digital audio between the congress units as well as between congress units and main unit(s)
- Audio signals processed by high performance DSP: sound quality approaching CD quality
- Gain and EQ (5 band) of each microphone adjustable separately, fitting the individual orator's voice to achieve perfect speech pickup any time
- Supporting 48 kHz audio sampling rate
- Integrated high-pass filter (low-cut switch) to cut low frequency elements from the audio when needed
- Automatic system recovery and "PnP" (plug and play)

- Stem microphone can be unplugged during adjournment, easy to maintain
- Mini-microphone, built-in foam windshield
- Excellent immunity to RF interference from mobile phones and comparable devices
- Microphone On/Off button
- Hand up button (discussion mode)
- An ID can be assigned by default or manually to each conference unit bearing a unique serial number for convenient maintenance
- Facilities in independent operation from computer:
 - ◆ Set the number of delegates permitted to speak at the same time
 - ◆ Speak mode: Open/Override/Voice/Request/PTT
 - "Open" mode, microphone On/Off button with request-to-speak registration (AUTO)
 - "Override" mode, microphone On/Off button control with override of the active microphones (FIFO)
 - "Voice" mode, acoustic active sensitivity and automatic switch-off time adjustable continuously, built-in "flash-on" technology, immediate microphone activation on speaking
 - "Request" mode, delegate requests to speak by pressing microphone On/Off button, delegate only speaks when operator or chairman approved his application
 - "PTT" mode, press microphone On/Off button to talk
- Automatic video tracking implementation when cooperating with cameras & video switcher unit; preset positions on PC
- Set any delegate unit to be VIP unit
 - ◆ Up to 32 units can be set as VIP in one system via application software
 - ◆ VIP unit can be activated as long as the total of active microphones is not beyond 8 (incl. chairman/delegate/VIP unit)

Controls and Indicators

- 4.3" touch screen for displaying:
 - ◆ Speaking list, timing speaking information, delegate information
 - ◆ Screen brightness, system language and unit information
- Uni-directional electret condenser microphone with bi-color illuminated ring
- Headphones volume control
- Microphone On/Off button with indicator

Interconnections

- Socket for pluggable microphone
- 2×Ø 3.5 mm stereo headphone jacks
- 1.5 m cable with 8P-DIN plug
- 0.6 m cable with 8P-DIN socket

Technical Specifications

Electrical

Max. consumption.....2.4 W

LCD

Dimension..... 4:3

Resolution.....800×480

Contrast.....800:1

Headphone connection

Frequency response.....20 Hz to 20 kHz
 Earphone load impedance.....>16 Ohm
 Earphone output.....10 mW

Recommended microphone type

Transducer.....Electret-condenser
 Polar pattern.....Uni-directional
 Operating voltage.....5 VDC
 Sensitivity.....-46 dBV/Pa
 Frequency response.....50 Hz to 20 kHz
 Input impedance.....2 kOhm
 Directivity 0°/180°.....> 20 dB (1 kHz)
 Equivalent noise.....20 dBA (SPL)
 Maximum sound pressure level.....125 dB (THD<3%)

Interface data

Connector.....2×Ø 3.5 mm stereo jacks for headphones

Mechanical

Mounting.....Tabletop
 Dimensions (h x w x d) (w/o stem microphone).....68 x 99 x 145 mm
 Weight (incl. stem microphone).....1.0 kg
 Color.....Black (PANTONE 419 C)
 Stem length.....330 mm, 410 mm (standard version), 470 mm

Ordering Information

HCS-4891D_B/80.....Fully Digital Congress System Delegate
 Unit (tabletop, discussion, 4.3" touch
 screen, black)

Function list

Model No.	Type	Speech	Voting	SI	4.3" touch screen	Main unit	Cable
HCS-4891CVS/80	Chairman	√	5-key	64CHs×2	√	HCS-4800MA/20	8-pin dedicated cable
HCS-4891DVS/80	Delegate	√	5-key	64CHs×2	√		
HCS-4891C/80	Chairman	√			√	HCS-4800MA/20 HCS-4800MB/20	
HCS-4891D/80	Delegate	√			√	HCS-4800MC	

HCS-4891RCVS/80 Chairman Unit with Voting and Channel Selection



Features

- **Elegant and ergonomic design**
- **Exquisite and delicate tabletop design for ease of use and transport**
- **Cable coming out of the base for a tidier wiring**
- **Priority button**
- **Rectangular columnar microphone, the pitching angle of the microphone is adjustable**
- **5-key voting**
- **Exquisite and sleek 4.3" touch screen for information display of meeting proceedings**
- **Supports custom boot screen and background picture**
- **"Closed Loop - Daisy Chain" connection topology**
- **64 CHs×2 interpretation with independent volume control. Two delegates may share one unit thus cutting the facility cost by half**
- **Transmitting up to 64 CHs high quality digital audio signals on a dedicated 8-pin cable**
- **Supporting 48 kHz audio sampling rate, all 64 channels perfectly reproducing audio frequencies between 20 Hz and 20 kHz**
- **Water resistant and noise-free button with long service life**
- **Excellent immunity to RF interference from mobile phones**
- **Separate adjustment of gain and EQ (5 band) of each microphone for the perfect sound**
- **Supporting "PnP" (plug and play)**

The stylish and ergonomically designed chairman unit has all the necessary facilities to enable the user to chair a conference. It has excellent immunity to RF interference from mobile phones. Similar in appearance to HCS-4891RDVS/80 Delegate Unit, the HCS-4891RCVS/80 Chairman Unit includes a microphone priority button. When pressed, the priority button causes all currently active delegate microphones to be switched off temporarily or permanently, allowing the chairman to take control of the meeting. A 4.3" touch screen can display speaking list, sign-in and voting information, channel number and language name, operation menu, etc. Channel selection is automatically limited to the number of language channels available.

Functions

- Compliant to ISO 22259
- "Closed Loop - Daisy Chain" connection topology for a high operational system reliability: breakdown or replacement of a congress unit and connection failure of a cable will not influence other congress units
- Based on TAIDEN originated MCA-STREAM digital audio processing and transmitting technologies
- Proprietary MCA-STREAM technology used to transmit fully digital audio between the congress units as well as between congress units and main unit(s)
- Audio signals processed by high performance DSP: sound quality approaching CD quality
- Hypercardioid uni-directional electret condenser microphone with bi-color illuminated ring
- Rectangular columnar microphone, the pitching angle of the microphone is adjustable
- Gain and EQ (5 band) of each microphone adjustable separately, fitting the individual orator's voice to achieve perfect speech pickup any time
- Transmitting up to 64 CHs high quality digital audio signals on a dedicated 8-pin cable (general cat5e cable with a drain wire substitutable)
- Supports up to 64 (1+63) CHs simultaneous interpretation
- Supports 48 kHz audio sampling, and all 64 channels perfectly reproducing audio frequencies between 20 Hz and 20 kHz
- 64 CHs×2 interpretation with volume control. Two delegates may share one unit thus cutting the cost by half (earphone needed)
- Integrated high-pass filter (low-cut switch) to cut low frequency elements from the audio when needed
- Automatic system recovery and "PnP" (plug and play)
- Excellent immunity to RF interference from mobile phones and comparable devices
- Microphone On/Off button, 5-key voting
- Hand up button (discussion mode)
- An ID can be assigned by default or manually to each conference unit bearing a unique serial number for convenient maintenance
- Facilities in independent operation from computer:
 - ◆ Set the number of delegates permitted to speak at the same time
 - ◆ Speak mode: Open/Override/Voice/Request/PTT
 - "Open" mode, microphone On/Off button with request-to-speak registration (AUTO)
 - "Override" mode, microphone On/Off button control with override of the active microphones (FIFO)
 - "Voice" mode, acoustic active sensitivity and automatic switch-off time adjustable continuously, built-in "flash-on" technology, immediate microphone activation on speaking
 - "Request" mode, delegate requests to speak by pressing microphone On/Off button, delegate only speaks when operator or chairman approved his application
 - "PTT" mode, press microphone On/Off button to talk
 - ◆ Simultaneous interpretation
- Multifunction voting function can be implemented in combination with the corresponding software
- Key-press sign-in

- Automatic video tracking implementation when cooperating with cameras & video switcher unit; preset positions on PC
- Activation at any time (if the amount of active microphones in the system is less than 8)
- Priority button to switch off or to mute the delegate units (except VIP units) according to preset
- Approves/denies delegates' speaking request
- System supports up to 100 chairman units, while all or part chairman units have the control facilities listed above (set by software or main unit)

Controls and Indicators

- 4.3" touch screen for displaying:
 - ◆ Speaking list, timing speaking information, delegate information
 - ◆ Sign-in and voting information
 - ◆ Language channel and earphone volume adjustment
 - ◆ Screen brightness, system language and unit information
- Built-in channel selector with channel selection function
- Hypercardioid uni-directional electret condenser microphone with bi-color illuminated ring
- Headphones volume control
- Five virtual voting buttons
- Microphone On/Off button with indicator
- Priority button

Interconnections

- 2×Ø 3.5 mm stereo headphone jacks
- 1.5 m cable with 8P-DIN plug
- 0.6 m cable with 8P-DIN socket

Technical Specifications

Electrical

Max. consumption.....2.4 W

LCD

Dimension.....4:3

Resolution.....800×480

Contrast.....800:1

Headphone connection

Frequency response.....20 Hz to 20 kHz

Earphone load impedance.....>16 Ohm

Earphone output.....10 mW

Recommended microphone type

Transducer.....Electret-condenser

Polar pattern.....Hypercardioid uni-directional
.....14mm gold-plating capacitance sound head

Operating voltage.....5 VDC

Sensitivity.....-37dBV/Pa

Frequency response.....20 Hz to 20 kHz

Input impedance.....2 kOhm

Directivity 0°/135°.....> 20 dB (1 kHz)

Directivity 0°/180°.....> 15 dB (1 kHz)

Equivalent noise.....20 dBA (SPL)

Maximum sound pressure level.....139 dB (THD<3%)

Interface data

Connector.....2×Ø 3.5 mm stereo jacks for headphones

Mechanical

Mounting.....Tabletop

Dimensions (h x w x d).....68 x 99 x 145 mm (base)

.....37 x 37 x 241 mm (microphone)

Weight (incl. microphone).....1.4 kg

Color.....Silver (PANTONE 401 C) microphone +
black (PANTONE 419 C) base

Ordering Information

HCS-4891RCVS_S/80....Fully Digital Congress System Chairman Unit (tabletop, discussion, 5-key voting, 64 CHs×2, 4.3" touch screen, rectangular columnar metal microphone, silver microphone + black base)

HCS-4891RDVS/80 Delegate Unit with Voting and Channel Selection



Features

- **Elegant and ergonomic design**
- **Exquisite and delicate tabletop design for ease of use and transport**
- **Cable coming out of the base for a tidier wiring**
- **Rectangular columnar microphone, the pitching angle of the microphone is adjustable**
- **5-key voting**
- **Exquisite and sleek 4.3" touch screen for information display of meeting proceedings**
- **Supports custom boot screen and background picture**
- **"Closed Loop - Daisy Chain" connection topology**
- **64 CHs×2 interpretation with independent volume control. Two delegates may share one unit thus cutting the facility cost by half**
- **Transmitting up to 64 CHs high quality digital audio signals on a dedicated 8-pin cable**
- **Supporting 48 kHz audio sampling rate, all 64 channels perfectly reproducing audio frequencies between 20 Hz and 20 kHz**
- **Water resistant and noise-free button with long service life**
- **Excellent immunity to RF interference from mobile phones**
- **Separate adjustment of gain and EQ (5 band) of each microphone for the perfect sound**
- **Supporting "PnP" (plug and play)**

The multi-functional delegate unit meets the demands of even the largest conferences. It provides facilities for speaking, registering a request-to-speak, listening, voting, selecting language channels and IC-Card sign-in. Excellent immunity to RF interference from mobile phones. A 4.3" touch screen can display speaking list, sign-in and voting information, channel number and language name, operation menu, etc. Channel selection is automatically limited to the number of language channels available.

Functions

- Compliant to ISO 22259
- "Closed Loop - Daisy Chain" connection topology for a high operational system reliability: breakdown or replacement of a congress unit and connection failure of a cable will not influence other congress units
- Based on TAIDEN originated MCA-STREAM digital audio processing and transmitting technologies
- Proprietary MCA-STREAM technology used to transmit fully digital audio between the congress units as well as between congress units and main unit(s)
- Audio signals processed by high performance DSP: sound quality approaching CD quality
- Hypercardioid uni-directional electret condenser microphone with bi-color illuminated ring
- Rectangular columnar microphone, the pitching angle of the microphone is adjustable
- Gain and EQ (5 band) of each microphone adjustable separately, fitting the individual orator's voice to achieve perfect speech pickup any time
- Transmitting up to 64 CHs high quality digital audio signals on a dedicated 8-pin cable (general cat5e cable with a drain wire substitutable)
- Supports up to 64 (1+63) CHs simultaneous interpretation
- Supports 48 kHz audio sampling, and all 64 channels perfectly reproducing audio frequencies between 20 Hz and 20 kHz
- 64 CHs×2 interpretation with volume control. Two delegates may share one unit thus cutting the cost by half (earphone needed)
- Integrated high-pass filter (low-cut switch) to cut low frequency elements from the audio when needed
- Automatic system recovery and "PnP" (plug and play)
- Excellent immunity to RF interference from mobile phones and comparable devices
- Microphone On/Off button, 5-key voting
- Hand up button (discussion mode)
- An ID can be assigned by default or manually to each conference unit bearing a unique serial number for convenient maintenance
- Facilities in independent operation from computer:
 - ◆ Set the number of delegates permitted to speak at the same time
 - ◆ Speak mode: Open/Override/Voice/Request/PTT
 - "Open" mode, microphone On/Off button with request-to-speak registration (AUTO)
 - "Override" mode, microphone On/Off button control with override of the active microphones (FIFO)
 - "Voice" mode, acoustic active sensitivity and automatic switch-off time adjustable continuously, built-in "flash-on" technology, immediate microphone activation on speaking
 - "Request" mode, delegate requests to speak by pressing microphone On/Off button, delegate only speaks when operator or chairman approved his application
 - "PTT" mode, press microphone On/Off button to talk
 - ◆ Simultaneous interpretation
- Multifunction voting function can be implemented in combination with the corresponding software
- Key-press sign-in

- Automatic video tracking implementation when cooperating with cameras & video switcher unit; preset positions on PC
- Set any delegate unit to be VIP unit
 - ◆ Up to 32 units can be set as VIP in one system via application software
 - ◆ VIP unit can be activated as long as the total of active microphones is not beyond 8 (incl. chairman/delegate/VIP unit)

Color.....Silver (PANTONE 401 C) microphone + black (PANTONE 419 C) base

Controls and Indicators

- 4.3" touch screen for displaying:
 - ◆ Speaking list, timing speaking information, delegate information
 - ◆ Sign-in and voting information
 - ◆ Language channel and earphone volume adjustment
 - ◆ Screen brightness, system language and unit information
- Built-in channel selector with channel selection function
- Hypercardioid uni-directional electret condenser microphone with bi-color illuminated ring
- Headphones volume control
- Five virtual voting buttons
- Microphone On/Off button with indicator

Ordering Information

HCS-4891RDVS_S/80.....Fully Digital Congress System Delegate Unit (tabletop, discussion, 5-key voting, 64 CHs×2, 4.3" touch screen, rectangular columnar metal microphone, silver microphone + black base)

Interconnections

- 2×Ø 3.5 mm stereo headphone jacks
- 1.5 m cable with 8P-DIN plug
- 0.6 m cable with 8P-DIN socket

Technical Specifications

Electrical

Max. consumption.....2.4 W

LCD

Dimension.....4:3

Resolution.....800×480

Contrast.....800:1

Headphone connection

Frequency response.....20 Hz to 20 kHz

Earphone load impedance.....>16 Ohm

Earphone output.....10 mW

Recommended microphone type

Transducer.....Electret-condenser

Polar pattern.....Hypercardioid uni-directional
.....14mm gold-plating capacitance sound head

Operating voltage.....5 VDC

Sensitivity.....-37 dBV/Pa

Frequency response.....20 Hz to 20 kHz

Input impedance.....2 kOhm

Directivity 0°/135°.....> 20 dB (1 kHz)

Directivity 0°/180°.....> 15 dB (1 kHz)

Equivalent noise.....20 dBA (SPL)

Maximum sound pressure level.....139 dB (THD<3%)

Interface data

Connector.....2×Ø 3.5 mm stereo jacks for headphones

Mechanical

Mounting.....Tabletop

Dimensions (h x w x d).....68 x 99 x 145 mm (base)

.....37 x 37 x 241 mm (microphone)

Weight (incl. microphone).....1.4 kg

HCS-4891RC/80 Chairman Unit



Features

- Elegant and ergonomic design
- Exquisite and delicate tabletop design for ease of use and transport
- Cable coming out of the base for a tidier wiring
- Priority button
- Rectangular columnar microphone, the pitching angle of the microphone is adjustable
- Exquisite and sleek 4.3" touch screen for information display of meeting proceedings
- Supports custom boot screen and background picture
- "Closed Loop - Daisy Chain" connection topology
- Supporting 48 kHz audio sampling rate
- Water resistant and noise-free button with long service life
- Excellent immunity to RF interference from mobile phones
- Separate adjustment of gain and EQ (5 band) of each microphone for the perfect sound
- Supporting "PnP" (plug and play)

The stylish and ergonomically designed chairman unit has all the necessary facilities to enable the user to chair a conference. It has excellent immunity to RF interference from mobile phones. Similar in appearance to HCS-4891RD/80 Delegate Unit, the HCS-4891RC/80 Chairman Unit includes a microphone priority button. When pressed, the priority button causes all currently active delegate microphones to be switched off temporarily or permanently, allowing the chairman to take control of the meeting. A 4.3" touch screen can display speaking list, operation menu, etc.

Functions

- Compliant to ISO 22259
- "Closed Loop - Daisy Chain" connection topology for a high operational system reliability: breakdown or replacement of a congress unit and connection failure of a cable will not influence other congress units
- Based on TAIDEN originated MCA-STREAM digital audio processing and transmitting technologies
- Proprietary MCA-STREAM technology used to transmit fully digital audio between the congress units as well as between congress units and main unit(s)

- Audio signals processed by high performance DSP: sound quality approaching CD quality
- Hypercardioid uni-directional electret condenser microphone with bi-color illuminated ring
- Rectangular columnar microphone, the pitching angle of the microphone is adjustable
- Gain and EQ (5 band) of each microphone adjustable separately, fitting the individual orator's voice to achieve perfect speech pickup any time
- Supporting 48 kHz audio sampling rate
- Integrated high-pass filter (low-cut switch) to cut low frequency elements from the audio when needed
- Automatic system recovery and "PnP" (plug and play)
- Excellent immunity to RF interference from mobile phones and comparable devices
- Microphone On/Off button
- Hand up button (discussion mode)
- An ID can be assigned by default or manually to each conference unit bearing a unique serial number for convenient maintenance
- Facilities in independent operation from computer:
 - ◆ Set the number of delegates permitted to speak at the same time
 - ◆ Speak mode: Open/Override/Voice/Request/PTT
 - "Open" mode, microphone On/Off button with request-to-speak registration (AUTO)
 - "Override" mode, microphone On/Off button control with override of the active microphones (FIFO)
 - "Voice" mode, acoustic active sensitivity and automatic switch-off time adjustable continuously, built-in "flash-on" technology, immediate microphone activation on speaking
 - "Request" mode, delegate requests to speak by pressing microphone On/Off button, delegate only speaks when operator or chairman approved his application
 - "PTT" mode, press microphone On/Off button to talk
- Automatic video tracking implementation when cooperating with cameras & video switcher unit; preset positions on PC
- Activation at any time (if the amount of active microphones in the system is less than 8)
- Priority button to switch off or to mute the delegate units (except VIP units) according to preset
- Approves/denies delegates' speaking request
- System supports up to 100 chairman units, while all or part chairman units have the control facilities listed above (set by software or main unit)

Controls and Indicators

- 4.3" touch screen for displaying:
 - ◆ Speaking list, timing speaking information, delegate information
 - ◆ Screen brightness, system language and unit information
- Hypercardioid uni-directional electret condenser microphone with bi-color illuminated ring
- Headphones volume control
- Microphone On/Off button with indicator
- Priority button

Interconnections

- 2×Ø 3.5 mm stereo headphone jacks
- 1.5 m cable with 8P-DIN plug
- 0.6 m cable with 8P-DIN socket

Technical Specifications

Electrical

Max. consumption.....2.4 W

LCD

Dimension.....4:3

Resolution.....800×480

Contrast.....800:1

Headphone connection

Frequency response.....20 Hz to 20 kHz

Earphone load impedance.....>16 Ohm

Earphone output.....10 mW

Recommended microphone type

Transducer.....Electret-condenser

Polar pattern.....Hypercardioid uni-directional

.....14mm gold-plating capacitance sound head

Operating voltage.....5 VDC

Sensitivity.....-37 dBV/Pa

Frequency response.....20 Hz to 20 kHz

Input impedance.....2 kOhm

Directivity 0°/135°.....> 20 dB (1 kHz)

Directivity 0°/180°.....> 15 dB (1 kHz)

Equivalent noise.....20 dBA (SPL)

Maximum sound pressure level.....139 dB (THD<3%)

Interface data

Connector.....2×Ø 3.5 mm stereo jacks for headphones

Mechanical

Mounting.....Tabletop

Dimensions (h x w x d).....68 x 99 x 145 mm (base)

.....37 x 37 x 241 mm (microphone)

Weight (incl. microphone).....1.4 kg

Color.....Silver (PANTONE 401 C) microphone +
black (PANTONE 419 C) base

Ordering Information

HCS-4891RC_S/80.....Fully Digital Congress System Chairman
Unit (tabletop, discussion, 4.3" touch
screen, rectangular columnar metal
microphone, silver microphone + black
base)

HCS-4891RD/80 Delegate Unit



Features

- Elegant and ergonomic design
- Exquisite and delicate tabletop design for ease of use and transport
- Cable coming out of the base for a tidier wiring
- Rectangular columnar microphone, the pitching angle of the microphone is adjustable
- Exquisite and sleek 4.3" touch screen for information display of meeting proceedings
- Supports custom boot screen and background picture
- "Closed Loop - Daisy Chain" connection topology
- Supporting 48 kHz audio sampling rate
- Water resistant and noise-free button with long service life
- Excellent immunity to RF interference from mobile phones
- Separate adjustment of gain and EQ (5 band) of each microphone for the perfect sound
- Supporting "PnP" (plug and play)

The multi-functional delegate unit meets the demands of even the largest conferences. It provides facilities for speaking, registering a request-to-speak, listening. Excellent immunity to RF interference from mobile phones. A 4.3" touch screen can display speaking list, operation menu, etc.

Functions

- Compliant to ISO 22259
- "Closed Loop - Daisy Chain" connection topology for a high operational system reliability: breakdown or replacement of a congress unit and connection failure of a cable will not influence other congress units
- Based on TAIDEN originated MCA-STREAM digital audio processing and transmitting technologies
- Proprietary MCA-STREAM technology used to transmit fully digital audio between the congress units as well as between congress units and main unit(s)
- Audio signals processed by high performance DSP: sound quality approaching CD quality
- Hypercardioid uni-directional electret condenser microphone with bi-color illuminated ring
- Rectangular columnar microphone, the pitching angle of the microphone is adjustable
- Gain and EQ (5 band) of each microphone adjustable separately, fitting the individual orator's voice to achieve perfect speech pickup any time
- Supporting 48 kHz audio sampling rate
- Integrated high-pass filter (low-cut switch) to cut low frequency elements from the audio when needed
- Automatic system recovery and "PnP" (plug and play)
- Excellent immunity to RF interference from mobile phones and comparable devices
- Microphone On/Off button
- Hand up button (discussion mode)
- An ID can be assigned by default or manually to each conference unit bearing a unique serial number for convenient maintenance
- Facilities in independent operation from computer:
 - ◆ Set the number of delegates permitted to speak at the same time
 - ◆ Speak mode: Open/Override/Voice/Request/PTT
 - "Open" mode, microphone On/Off button with request-to-speak registration (AUTO)
 - "Override" mode, microphone On/Off button control with override of the active microphones (FIFO)
 - "Voice" mode, acoustic active sensitivity and automatic switch-off time adjustable continuously, built-in "flash-on" technology, immediate microphone activation on speaking
 - "Request" mode, delegate requests to speak by pressing microphone On/Off button, delegate only speaks when operator or chairman approved his application
 - "PTT" mode, press microphone On/Off button to talk
- Automatic video tracking implementation when cooperating with cameras & video switcher unit; preset positions on PC
- Set any delegate unit to be VIP unit
 - ◆ Up to 32 units can be set as VIP in one system via application software
 - ◆ VIP unit can be activated as long as the total of active microphones is not beyond 8 (incl. chairman/delegate/VIP unit)

Controls and Indicators

- 4.3" touch screen for displaying:
 - ◆ Speaking list, timing speaking information, delegate information
 - ◆ Screen brightness, system language and unit information
- Hypercardioid uni-directional electret condenser microphone with bi-color illuminated ring
- Headphones volume control
- Microphone On/Off button with indicator

Interconnections

- 2×Ø 3.5 mm stereo headphone jacks
- 1.5 m cable with 8P-DIN plug
- 0.6 m cable with 8P-DIN socket

Technical Specifications

Electrical

Max. consumption.....2.4 W

LCD

Dimension.....4:3

Resolution.....800×480

Contrast.....800:1

Headphone connection

Frequency response.....20 Hz to 20 kHz

Earphone load impedance.....>16 Ohm

Earphone output.....10 mW

Recommended microphone type

Transducer.....Electret-condenser

Polar pattern.....Hypercardioid uni-directional
.....14mm gold-plating capacitance sound head

Operating voltage.....5 VDC

Sensitivity.....-37 dBV/Pa

Frequency response.....20 Hz to 20 kHz

Input impedance.....2 kOhm

Directivity 0°/135°.....> 20 dB (1 kHz)

Directivity 0°/180°.....> 15 dB (1 kHz)

Equivalent noise.....20 dBA (SPL)

Maximum sound pressure level.....139 dB (THD<3%)

Interface data

Connector.....2×Ø 3.5 mm stereo jacks for headphones

Mechanical

Mounting.....Tabletop

Dimensions (h x w x d).....68 x 99 x 145 mm (base)

.....37 x 37 x 241 mm (microphone)

Weight (incl. microphone).....1.4 kg

Color.....Silver (PANTONE 401 C) microphone +
.....black (PANTONE 419 C) base

Ordering Information

HCS-4891RD_S/80.....Fully Digital Congress System Delegate Unit
(tabletop, discussion, 4.3" touch screen,
rectangular columnar metal microphone,
silver microphone + black base)

User interface

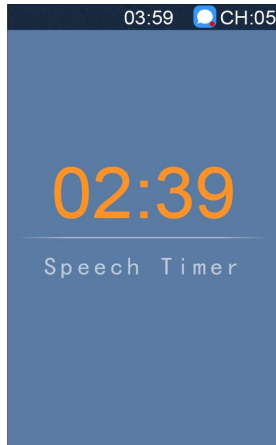

Speech Timer



Speaking list

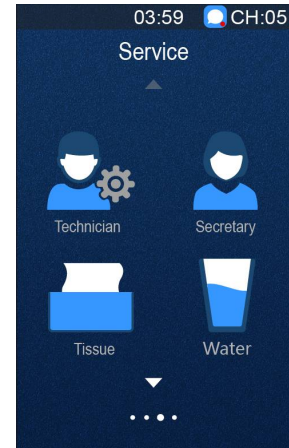

Service

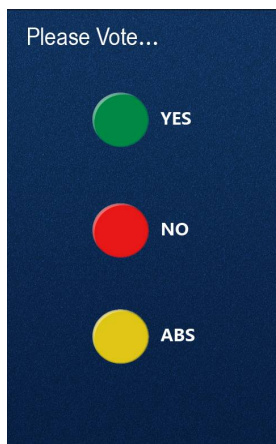

Voting

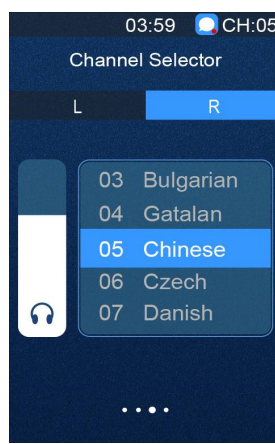

Simultaneous interpretation

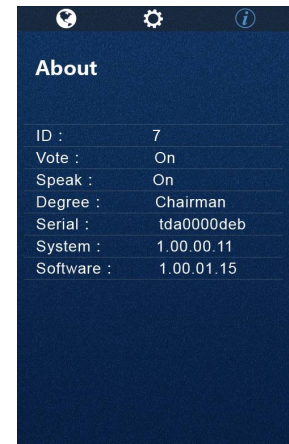

About

Function list

Model No.	Type	Speech	Voting	SI	4.3" touch screen	Main unit	Cable
HCS-4891RCVS/80	Chairman	√	5-key	64CHs×2	√	HCS-4800MA	8-pin dedicated cable
HCS-4891RDVS/80	Delegate	√	5-key	64CHs×2	√		
HCS-4891RC/80	Chairman	√			√	HCS-4800MA/20 HCS-4800MB/20	
HCS-4891RD/80	Delegate	√			√	HCS-4800MC	

HCS-4891RCVS/80/2M Chairman Unit with Voting and Channel Selection



Features

- **Elegant and ergonomic design**
- **Exquisite and delicate tabletop design for ease of use and transport**
- **Cable coming out of the base for a tidier wiring**
- **Priority button**
- **Rectangular columnar microphone, the pitching angle of the microphone is adjustable**
- **Built-in isolated main microphone and backup microphone**
- **5-key voting**
- **Exquisite and sleek 4.3" touch screen for information display of meeting proceedings**
- **Supports custom boot screen and background picture**
- **"Closed Loop - Daisy Chain" connection topology**
- **64 CHs×2 interpretation with independent volume control. Two delegates may share one unit thus cutting the facility cost by half**
- **Transmitting up to 64 CHs high quality digital audio signals on a dedicated 8-pin cable**
- **Supporting 48 kHz audio sampling rate, all 64 channels perfectly reproducing audio frequencies between 20 Hz and 20 kHz**
- **Water resistant and noise-free button with long service life**
- **Excellent immunity to RF interference from mobile phones**
- **Separate adjustment of gain and EQ (5 band) of each microphone for the perfect sound**
- **Supporting "PnP" (plug and play)**

The stylish and ergonomically designed chairman unit has all the necessary facilities to enable the user to chair a conference. It has excellent immunity to RF interference from mobile phones. Similar in appearance to HCS-4891RDVS/80/2M Delegate Unit, the HCS-4891RCVS/80/2M Chairman Unit includes a microphone priority button. When pressed, the priority button causes all currently active delegate microphones to be switched off temporarily or permanently, allowing the chairman to take control of the meeting. A 4.3" touch screen can display speaking list, sign-in and voting information, channel number and language name, operation menu, etc. Channel selection is automatically limited to the number of language channels available.

Functions

- Compliant to ISO 22259
- "Closed Loop - Daisy Chain" connection topology for a high operational system reliability: breakdown or replacement of a congress unit and connection failure of a cable will not influence other congress units
- Based on TAIDEN originated MCA-STREAM digital audio processing and transmitting technologies
- Proprietary MCA-STREAM technology used to transmit fully digital audio between the congress units as well as between congress units and main unit(s)
- Audio signals processed by high performance DSP: sound quality approaching CD quality
- Hypercardioid uni-directional electret condenser microphone with bi-color illuminated ring
- Rectangular columnar microphone, the pitching angle of the microphone is adjustable
- Built-in an electrets main microphone and a backup microphone both with hypercardioid polar pattern. In case the main microphone system malfunctions, the backup microphone system can take over to ensure an uninterrupted meeting flow
- Gain and EQ (5 band) of each microphone adjustable separately, fitting the individual orator's voice to achieve perfect speech pickup any time
- Transmitting up to 64 CHs high quality digital audio signals on a dedicated 8-pin cable (general cat5e cable with a drain wire substitutable)
- Supports up to 64 (1+63) CHs simultaneous interpretation
- Supports 48 kHz audio sampling, and all 64 channels perfectly reproducing audio frequencies between 20 Hz and 20 kHz
- 64 CHs×2 interpretation with volume control. Two delegates may share one unit thus cutting the cost by half (earphone needed)
- Integrated high-pass filter (low-cut switch) to cut low frequency elements from the audio when needed
- Automatic system recovery and "PnP" (plug and play)
- Excellent immunity to RF interference from mobile phones and comparable devices
- Microphone On/Off button, 5-key voting
- Hand up button (discussion mode)
- An ID can be assigned by default or manually to each conference unit bearing a unique serial number for convenient maintenance
- Facilities in independent operation from computer:
 - ◆ Set the number of delegates permitted to speak at the same time
 - ◆ Speak mode: Open/Override/Voice/Request/PTT
 - "Open" mode, microphone On/Off button with request-to-speak registration (AUTO)
 - "Override" mode, microphone On/Off button control with override of the active microphones (FIFO)
 - "Voice" mode, acoustic active sensitivity and automatic switch-off time adjustable continuously, built-in "flash-on" technology, immediate microphone activation on speaking
 - "Request" mode, delegate requests to speak by pressing microphone On/Off button, delegate only speaks when operator or chairman approved his application
 - "PTT" mode, press microphone On/Off button to talk
 - ◆ Simultaneous interpretation

- Multiform voting function can be implemented in combination with the corresponding software
- Key-press sign-in
- Automatic video tracking implementation when cooperating with cameras & video switcher unit; preset positions on PC
- Activation at any time (if the amount of active microphones in the system is less than 8)
- Priority button to switch off or to mute the delegate units (except VIP units) according to preset
- Approves/denies delegates' speaking request
- System supports up to 100 chairman units, while all or part chairman units have the control facilities listed above (set by software or main unit)

Controls and Indicators

- 4.3" touch screen for displaying:
 - ◆ Speaking list, timing speaking information, delegate information
 - ◆ Sign-in and voting information
 - ◆ Language channel and earphone volume adjustment
 - ◆ Screen brightness, system language and unit information
- Built-in channel selector with channel selection function
- Hypercardioid uni-directional electret condenser microphone with bi-color illuminated ring
- Headphones volume control
- Five virtual voting buttons
- Microphone On/Off button with indicator
- Priority button

Interconnections

- 2×Ø 3.5 mm stereo headphone jacks
- 1.5 m cable with 8P-DIN plug
- 0.6 m cable with 8P-DIN socket

Technical Specifications

Electrical

Max. consumption.....2.4 W

LCD

Dimension.....4:3

Resolution.....800×480

Contrast.....800:1

Headphone connection

Frequency response.....20 Hz to 20 kHz

Earphone load impedance.....>16 Ohm

Earphone output.....10 mW

Main microphone type

Transducer.....Electret-condenser

Polar pattern.....Hypercardioid uni-directional

Operating voltage.....5 VDC

Sensitivity.....-37 dBV/Pa

Frequency response.....20 Hz to 20 kHz

Input impedance.....2 kOhm

Directivity 0°/135°.....> 20 dB (1 kHz)

Directivity 0°/180°.....> 15 dB (1 kHz)

Equivalent noise.....20 dBA (SPL)

Maximum sound pressure level.....139 dB (THD<3%)

Backup microphone type

Transducer.....Electret-condenser

Polar pattern.....Hypercardioid uni-directional

.....14mm gold-plating capacitance sound head

Phantom power.....11~52 VDC, 2 mA

Sensitivity.....-37 dBV/Pa

Frequency response.....20 Hz to 20 kHz

Output impedance.....280 Ohm

Directivity 0°/135°.....> 20 dB (1 kHz)

Directivity 0°/180°.....> 15 dB (1 kHz)

Equivalent noise.....20 dBA (SPL)

Maximum sound pressure level.....139 dB (THD<3%)

Connection.....XLRM-type connector

Interface data

Connector.....2×Ø 3.5 mm stereo jacks for headphones

Mechanical

Mounting.....Tabletop

Dimensions (h x w x d).....68 x 99 x 145 mm (base)

.....37 x 37 x 249 mm (microphone)

Weight (incl. microphone).....1.5 kg

Color.....Silver (PANTONE 401 C) microphone +

black (PANTONE 419 C) base

Ordering Information

HCS-4891RCVS_S/80/2M...Fully Digital Congress System
 Chairman Unit (tabletop, discussion,
 5-key voting, 64 CHs×2, 4.3" touch
 screen, rectangular columnar metal
 microphone, main microphone +
 backup microphone, silver
 microphone + black base)

HCS-4891RDVS/80/2M Delegate Unit with Voting and Channel Selection



Features

- **Elegant and ergonomic design**
- **Exquisite and delicate tabletop design for ease of use and transport**
- **Cable coming out of the base for a tidier wiring**
- **Rectangular columnar microphone, the pitching angle of the microphone is adjustable**
- **Built-in isolated main microphone and backup microphone**
- **5-key voting**
- **Exquisite and sleek 4.3" touch screen for information display of meeting proceedings**
- **Supports custom boot screen and background picture**
- **"Closed Loop - Daisy Chain" connection topology**
- **64 CHs×2 interpretation with independent volume control. Two delegates may share one unit thus cutting the facility cost by half**
- **Transmitting up to 64 CHs high quality digital audio signals on a dedicated 8-pin cable**
- **Supporting 48 kHz audio sampling rate, all 64 channels perfectly reproducing audio frequencies between 20 Hz and 20 kHz**
- **Water resistant and noise-free button with long service life**
- **Excellent immunity to RF interference from mobile phones**
- **Separate adjustment of gain and EQ (5 band) of each microphone for the perfect sound**
- **Supporting "PnP" (plug and play)**

The multi-functional delegate unit meets the demands of even the largest conferences. It provides facilities for speaking, registering a request-to-speak, listening, voting, selecting language channels and IC-Card sign-in. Excellent immunity to RF interference from mobile phones. A 4.3" touch screen can display speaking list, sign-in and voting information, channel number and language name, operation menu, etc. Channel selection is automatically limited to the number of language channels available.

Functions

- Compliant to ISO 22259
- "Closed Loop - Daisy Chain" connection topology for a high operational system reliability: breakdown or replacement of a congress unit and connection failure of a cable will not influence other congress units
- Based on TAIDEN originated MCA-STREAM digital audio processing and transmitting technologies
- Proprietary MCA-STREAM technology used to transmit fully digital audio between the congress units as well as between congress units and main unit(s)
- Audio signals processed by high performance DSP: sound quality approaching CD quality
- Hypercardioid uni-directional electret condenser microphone with bi-color illuminated ring
- Rectangular columnar microphone, the pitching angle of the microphone is adjustable
- Built-in an electrets main microphone and a backup microphone both with hypercardioid polar pattern. In case the main microphone system malfunctions, the backup microphone system can take over to ensure an uninterrupted meeting flow
- Gain and EQ (5 band) of each microphone adjustable separately, fitting the individual orator's voice to achieve perfect speech pickup any time
- Transmitting up to 64 CHs high quality digital audio signals on a dedicated 8-pin cable (general cat5e cable with a drain wire substitutable)
- Supports up to 64 (1+63) CHs simultaneous interpretation
- Supports 48 kHz audio sampling, and all 64 channels perfectly reproducing audio frequencies between 20 Hz and 20 kHz
- 64 CHs×2 interpretation with volume control. Two delegates may share one unit thus cutting the cost by half (earphone needed)
- Integrated high-pass filter (low-cut switch) to cut low frequency elements from the audio when needed
- Automatic system recovery and "PnP" (plug and play)
- Excellent immunity to RF interference from mobile phones and comparable devices
- Microphone On/Off button, 5-key voting
- Hand up button (discussion mode)
- An ID can be assigned by default or manually to each conference unit bearing a unique serial number for convenient maintenance
- Facilities in independent operation from computer:
 - ◆ Set the number of delegates permitted to speak at the same time
 - ◆ Speak mode: Open/Override/Voice/Request/PTT
 - "Open" mode, microphone On/Off button with request-to-speak registration (AUTO)
 - "Override" mode, microphone On/Off button control with override of the active microphones (FIFO)
 - "Voice" mode, acoustic active sensitivity and automatic switch-off time adjustable continuously, built-in "flash-on" technology, immediate microphone activation on speaking
 - "Request" mode, delegate requests to speak by pressing microphone On/Off button, delegate only speaks when operator or chairman approved his application
 - "PTT" mode, press microphone On/Off button to talk
 - ◆ Simultaneous interpretation

- Multiform voting function can be implemented in combination with the corresponding software
- Key-press sign-in
- Automatic video tracking implementation when cooperating with cameras & video switcher unit; preset positions on PC
- Set any delegate unit to be VIP unit
 - ◆ Up to 32 units can be set as VIP in one system via application software
 - ◆ VIP unit can be activated as long as the total of active microphones is not beyond 8 (incl. chairman/delegate/VIP unit)

Controls and Indicators

- 4.3" touch screen for displaying:
 - ◆ Speaking list, timing speaking information, delegate information
 - ◆ Sign-in and voting information
 - ◆ Language channel and earphone volume adjustment
 - ◆ Screen brightness, system language and unit information
- Built-in channel selector with channel selection function
- Hypercardioid uni-directional electret condenser microphone with bi-color illuminated ring
- Headphones volume control
- Five virtual voting buttons
- Microphone On/Off button with indicator

Interconnections

- 2×Ø 3.5 mm stereo headphone jacks
- 1.5 m cable with 8P-DIN plug
- 0.6 m cable with 8P-DIN socket

Sensitivity.....	-37 dBV/Pa
Frequency response.....	20 Hz to 20 kHz
Output impedance.....	280 Ohm
Directivity 0°/135°.....	> 20 dB (1 kHz)
Directivity 0°/180°.....	> 15 dB (1 kHz)
Equivalent noise.....	20 dBA (SPL)
Maximum sound pressure level.....	139 dB (THD<3%)
Connection.....	XLRM-type connector

Interface data

Connector.....2×Ø 3.5 mm stereo jacks for headphones

Mechanical

Mounting.....	Tabletop
Dimensions (h x w x d).....	68 x 99 x 145 mm (base)
.....	37 x 37 x 249 mm (microphone)
Weight (incl. microphone).....	1.5 kg
Color.....	Silver (PANTONE 401 C) microphone + black (PANTONE 419 C) base

Ordering Information

HCS-4891RDVS_S/80/2M.....Fully Digital Congress System Delegate Unit (tabletop, discussion, 5-key voting, 64 CHs×2, 4.3" touch screen, rectangular columnar metal microphone, main microphone + backup microphone, silver microphone + black base)

Technical Specifications

Electrical

Max. consumption.....2.4 W

LCD

Dimension.....	4:3
Resolution.....	800×480
Contrast.....	800:1

Headphone connection

Frequency response.....	20 Hz to 20 kHz
Earphone load impedance.....	>16 Ohm
Earphone output.....	10 mW

Main microphone type

Transducer.....	Electret-condenser
Polar pattern.....	Hypercardioid uni-directional

Operating voltage.....	5 VDC
Sensitivity.....	-37 dBV/Pa
Frequency response.....	20 Hz to 20 kHz
Input impedance.....	2 kOhm
Directivity 0°/135°.....	> 20 dB (1 kHz)
Directivity 0°/180°.....	> 15 dB (1 kHz)
Equivalent noise.....	20 dBA (SPL)
Maximum sound pressure level.....	139 dB (THD<3%)

Backup microphone type

Transducer.....	Electret-condenser
Polar pattern.....	Hypercardioid uni-directional
Phantom power.....	11~52 VDC, 2 mA

HCS-4891RC/80/2M Chairman Unit



Features

- **Elegant and ergonomic design**
- **Exquisite and delicate tabletop design for ease of use and transport**
- **Cable coming out of the base for a tidier wiring**
- **Priority button**
- **Rectangular columnar microphone, the pitching angle of the microphone is adjustable**
- **Built-in isolated main microphone and backup microphone**
- **Exquisite and sleek 4.3" touch screen for information display of meeting proceedings**
- **Supports custom boot screen and background picture**
- **"Closed Loop - Daisy Chain" connection topology**
- **Supporting 48 kHz audio sampling rate**
- **Water resistant and noise-free button with long service life**
- **Excellent immunity to RF interference from mobile phones**
- **Separate adjustment of gain and EQ (5 band) of each microphone for the perfect sound**
- **Supporting "PnP" (plug and play)**
- **Audio signals processed by high performance DSP: sound quality approaching CD quality**
- **Hypercardioid uni-directional electret condenser microphone with bi-color illuminated ring**
- **Rectangular columnar microphone, the pitching angle of the microphone is adjustable**
- **Built-in an electrets main microphone and a backup microphone both with hypercardioid polar pattern. In case the main microphone system malfunctions, the backup microphone system can take over to ensure an uninterrupted meeting flow**
- **Gain and EQ (5 band) of each microphone adjustable separately, fitting the individual orator's voice to achieve perfect speech pickup any time**
- **Supporting 48 kHz audio sampling rate**
- **Integrated high-pass filter (low-cut switch) to cut low frequency elements from the audio when needed**
- **Automatic system recovery and "PnP" (plug and play)**
- **Excellent immunity to RF interference from mobile phones and comparable devices**
- **Microphone On/Off button**
- **Hand up button (discussion mode)**
- **An ID can be assigned by default or manually to each conference unit bearing a unique serial number for convenient maintenance**
- **Facilities in independent operation from computer:**
 - ◆ **Set the number of delegates permitted to speak at the same time**
 - ◆ **Speak mode: Open/Override/Voice/Request/PTT**
 - "Open" mode, microphone On/Off button with request-to-speak registration (AUTO)
 - "Override" mode, microphone On/Off button control with override of the active microphones (FIFO)
 - "Voice" mode, acoustic active sensitivity and automatic switch-off time adjustable continuously, built-in "flash-on" technology, immediate microphone activation on speaking
 - "Request" mode, delegate requests to speak by pressing microphone On/Off button, delegate only speaks when operator or chairman approved his application
 - "PTT" mode, press microphone On/Off button to talk
- **Automatic video tracking implementation when cooperating with cameras & video switcher unit; preset positions on PC**
- **Activation at any time (if the amount of active microphones in the system is less than 8)**
- **Priority button to switch off or to mute the delegate units (except VIP units) according to preset**
- **Approves/denies delegates' speaking request**
- **System supports up to 100 chairman units, while all or part chairman units have the control facilities listed above (set by software or main unit)**

The stylish and ergonomically designed chairman unit has all the necessary facilities to enable the user to chair a conference. It has excellent immunity to RF interference from mobile phones. Similar in appearance to HCS-4891RD/80/2M Delegate Unit, the HCS-4891RC/80/2M Chairman Unit includes a microphone priority button. When pressed, the priority button causes all currently active delegate microphones to be switched off temporarily or permanently, allowing the chairman to take control of the meeting. A 4.3" touch screen can display speaking list, operation menu, etc.

Functions

- **Compliant to ISO 22259**
- **"Closed Loop - Daisy Chain" connection topology for a high operational system reliability: breakdown or replacement of a congress unit and connection failure of a cable will not influence other congress units**
- **Based on TAIDEN originated MCA-STREAM digital audio processing and transmitting technologies**
- **Proprietary MCA-STREAM technology used to transmit fully digital audio between the congress units as well as between congress units and main unit(s)**

Controls and Indicators

- **4.3" touch screen for displaying:**
 - ◆ **Speaking list, timing speaking information, delegate information**
 - ◆ **Screen brightness, system language and unit information**
- **Hypercardioid uni-directional electret condenser microphone with bi-color illuminated ring**
- **Headphones volume control**
- **Microphone On/Off button with indicator**
- **Priority button**

Interconnections

- 2×Ø 3.5 mm stereo headphone jacks
- 1.5 m cable with 8P-DIN plug
- 0.6 m cable with 8P-DIN socket

Technical Specifications

Electrical

Max. consumption.....2.4 W

LCD

Dimension.....4:3

Resolution.....800×480

Contrast.....800:1

Headphone connection

Frequency response.....20 Hz to 20 kHz

Earphone load impedance.....>16 Ohm

Earphone output.....10 mW

Main microphone type

Transducer.....Electret-condenser

Polar pattern.....Hypercardioid uni-directional

Operating voltage.....5 VDC

Sensitivity.....-38 dBV/Pa

Frequency response.....20 Hz to 20 kHz

Input impedance.....2 kOhm

Directivity 0°/135°.....> 20 dB (1 kHz)

Directivity 0°/180°.....> 15 dB (1 kHz)

Equivalent noise.....20 dBA (SPL)

Maximum sound pressure level.....139 dB (THD<3%)

Backup microphone type

Transducer.....Electret-condenser

Polar pattern.....Hypercardioid uni-directional

.....14mm gold-plating capacitance sound head

Phantom power.....11~52 VDC, 2 mA

Sensitivity.....-37 dBV/Pa

Frequency response.....20 Hz to 20 kHz

Output impedance.....280 Ohm

Directivity 0°/135°.....> 20 dB (1 kHz)

Directivity 0°/180°.....> 15 dB (1 kHz)

Equivalent noise.....20 dBA (SPL)

Maximum sound pressure level.....139 dB (THD<3%)

Connection.....XLRM-type connector

Interface data

Connector.....2×Ø 3.5 mm stereo jacks for headphones

Mechanical

Mounting.....Tabletop

Dimensions (h x w x d).....68 x 99 x 145 mm (base)

.....37 x 37 x 249 mm (microphone)

Weight (incl. microphone).....1.5 kg

Color.....Silver (PANTONE 401 C) microphone +
black (PANTONE 419 C) base

Ordering Information

HCS-4891RC_S/80/2M.....Fully Digital Congress System Chairman
Unit (tabletop, discussion, 4.3" touch
screen, rectangular columnar metal
microphone, main microphone + backup
microphone, silver microphone + black
base)

HCS-4891RD/80/2M Delegate Unit



Features

- Elegant and ergonomic design
- Exquisite and delicate tabletop design for ease of use and transport
- Cable coming out of the base for a tidier wiring
- Rectangular columnar microphone, the pitching angle of the microphone is adjustable
- Built-in isolated main microphone and backup microphone
- Exquisite and sleek 4.3" touch screen for information display of meeting proceedings
- Supports custom boot screen and background picture
- "Closed Loop - Daisy Chain" connection topology
- Supporting 48 kHz audio sampling rate
- Water resistant and noise-free button with long service life
- Excellent immunity to RF interference from mobile phones
- Separate adjustment of gain and EQ (5 band) of each microphone for the perfect sound
- Supporting "PnP" (plug and play)

The multi-functional delegate unit meets the demands of even the largest conferences. It provides facilities for speaking, registering a request-to-speak, listening. Excellent immunity to RF interference from mobile phones. A 4.3" touch screen can display speaking list, operation menu, etc.

Functions

- Compliant to ISO 22259
- "Closed Loop - Daisy Chain" connection topology for a high operational system reliability: breakdown or replacement of a congress unit and connection failure of a cable will not influence other congress units
- Based on TAIDEN originated MCA-STREAM digital audio processing and transmitting technologies
- Proprietary MCA-STREAM technology used to transmit fully digital audio between the congress units as well as between congress units and main unit(s)
- Audio signals processed by high performance DSP: sound quality approaching CD quality
- Hypercardioid uni-directional electret condenser microphone with bi-color illuminated ring
- Rectangular columnar microphone, the pitching angle of the microphone is adjustable
- Built-in an electrets main microphone and a backup microphone both with hypercardioid polar pattern. In case the main microphone system malfunctions, the backup microphone system can take over to ensure an uninterrupted meeting flow
- Gain and EQ (5 band) of each microphone adjustable separately, fitting the individual orator's voice to achieve perfect speech pickup any time
- Supporting 48 kHz audio sampling rate
- Integrated high-pass filter (low-cut switch) to cut low frequency elements from the audio when needed
- Automatic system recovery and "PnP" (plug and play)
- Excellent immunity to RF interference from mobile phones and comparable devices
- Microphone On/Off button
- Hand up button (discussion mode)
- An ID can be assigned by default or manually to each conference unit bearing a unique serial number for convenient maintenance
- Facilities in independent operation from computer:
 - ◆ Set the number of delegates permitted to speak at the same time
 - ◆ Speak mode: Open/Override/Voice/Request/PTT
 - "Open" mode, microphone On/Off button with request-to-speak registration (AUTO)
 - "Override" mode, microphone On/Off button control with override of the active microphones (FIFO)
 - "Voice" mode, acoustic active sensitivity and automatic switch-off time adjustable continuously, built-in "flash-on" technology, immediate microphone activation on speaking
 - "Request" mode, delegate requests to speak by pressing microphone On/Off button, delegate only speaks when operator or chairman approved his application
 - "PTT" mode, press microphone On/Off button to talk
- Automatic video tracking implementation when cooperating with cameras & video switcher unit; preset positions on PC
- Set any delegate unit to be VIP unit
 - ◆ Up to 32 units can be set as VIP in one system via application software
 - ◆ VIP unit can be activated as long as the total of active microphones is not beyond 8 (incl. chairman/delegate/VIP unit)

Controls and Indicators

- 4.3" touch screen for displaying:
 - ◆ Speaking list, timing speaking information, delegate information
 - ◆ Screen brightness, system language and unit information
- Hypercardioid uni-directional electret condenser microphone with bi-color illuminated ring
- Headphones volume control
- Microphone On/Off button with indicator

Interconnections

- 2×Ø 3.5 mm stereo headphone jacks
- 1.5 m cable with 8P-DIN plug
- 0.6 m cable with 8P-DIN socket

Technical Specifications

Electrical

Max. consumption.....2.4 W

LCD

Dimension.....4:3

Resolution.....800×480

Contrast.....800:1

Headphone connection

Frequency response.....20 Hz to 20 kHz

Earphone load impedance.....>16 Ohm

Earphone output.....10 mW

Main microphone type

Transducer.....Electret-condenser

Polar pattern.....Hypercardioid uni-directional

Operating voltage.....5 VDC

Sensitivity.....-37 dBV/Pa

Frequency response.....20 Hz to 20 kHz

Input impedance.....2 kOhm

Directivity 0°/135°.....> 20 dB (1 kHz)

Directivity 0°/180°.....> 15 dB (1 kHz)

Equivalent noise.....20 dBA (SPL)

Maximum sound pressure level.....139 dB (THD<3%)

Backup microphone type

Transducer.....Electret-condenser

Polar pattern.....Hypercardioid uni-directional

.....14mm gold-plating capacitance sound head

Phantom power.....11~52 VDC, 2 mA

Sensitivity.....-37 dBV/Pa

Frequency response.....20 Hz to 20 kHz

Output impedance.....280 Ohm

Directivity 0°/135°.....> 20 dB (1 kHz)

Directivity 0°/180°.....> 15 dB (1 kHz)

Equivalent noise.....20 dBA (SPL)

Maximum sound pressure level.....139 dB (THD<3%)

Connection.....XLRM-type connector

Interface data

Connector.....2×Ø 3.5 mm stereo jacks for headphones

Mechanical

Mounting.....Tabletop

Dimensions (h x w x d).....68 x 99 x 145 mm (base)

.....37 x 37 x 249 mm (microphone)

Weight (incl. microphone).....1.5 kg

Color.....Silver (PANTONE 401 C) microphone + black (PANTONE 419 C) base

Ordering Information

HCS-4891RD_S/80/2M.....Fully Digital Congress System Delegate Unit (tabletop, discussion, 4.3" touch screen, rectangular columnar metal microphone, main microphone + backup microphone, silver microphone + black base)

User interface

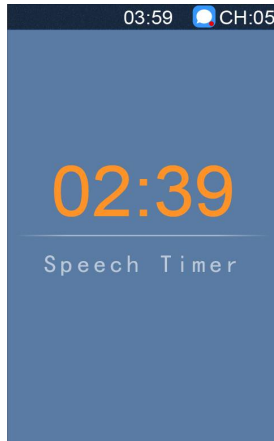

Speech Timer



Speaking list

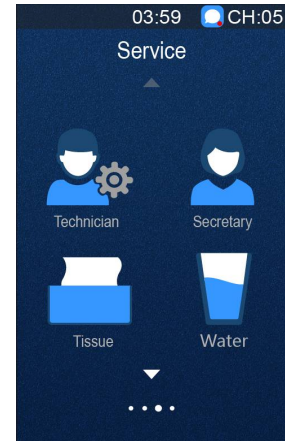

Service

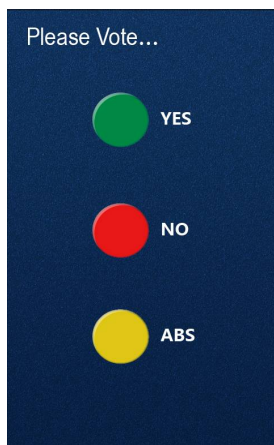

Voting

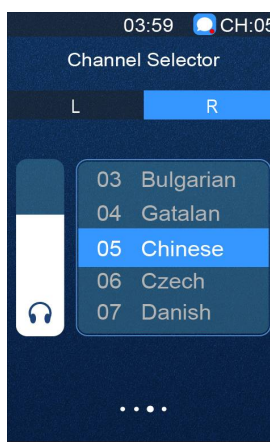

Simultaneous interpretation

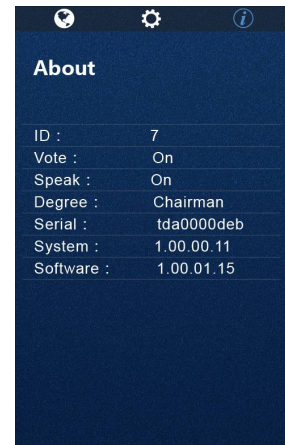

About

Function list

Model No.	Type	Speech	Voting	SI	4.3" touch screen	Main unit	Cable
HCS-4891RCVS/80/2M	Chairman	√	5-key	64CHs×2	√	HCS-4800MA/20	8-pin dedicated cable
HCS-4891RDVS/80/2M	Delegate	√	5-key	64CHs×2	√		
HCS-4891RC/80/2M	Chairman	√			√	HCS-4800MA/20	
HCS-4891RD/80/2M	Delegate	√			√	HCS-4800MB/20 HCS-4800MC/20	

HCS-4838CS/80 Chairman Unit with Channel Selection



Features

- **Elegant and ergonomic design**
- **Exquisite and delicate tabletop design for ease of use and transport**
- **Cable coming out of the base for a tidier wiring**
- **Hi-Fi loudspeaker**
- **Priority button**
- **Microphone On/Off button**
- **Braille is present for physical buttons**
- **Pluggable microphone**
- **OLED screen with high brightness and contrast, wide viewing angle and low power consumption**
- **“Closed Loop - Daisy Chain” connection topology**
- **Transmitting up to 64 CHs high quality digital audio signals on a dedicated 8-pin cable**
- **Supporting 48 kHz audio sampling rate, all 64 channels perfectly reproducing audio frequencies between 20 Hz and 20 kHz**
- **Excellent immunity to RF interference from mobile phones**
- **Separate adjustment of gain and EQ (5 band) of each microphone for the perfect sound**
- **Supporting “PnP” (plug and play)**

The stylish and ergonomically designed chairman unit has all the necessary facilities to enable the user to chair a conference. It has excellent immunity to RF interference from mobile phones. Similar in appearance to HCS-4838DS Delegate Unit, the HCS-4838CS/80 Chairman Unit includes a microphone priority button. When pressed, the priority button causes all currently active delegate microphones to be switched off temporarily or permanently, allowing the chairman to take control of the meeting. A graphic OLED can display channel number and language name. Channel selection is automatically limited to the number of language channels available.

The loudspeaker offers superior acoustics with minimal feedback for enhanced intelligibility.

Functions

- Compliant to ISO 22259
- “Closed Loop - Daisy Chain” connection topology for a high operational system reliability: breakdown or replacement of a congress unit and connection failure of a cable will not influence other congress units
- Based on TAIDEN originated MCA-STREAM digital audio processing and transmitting technologies
- Proprietary MCA-STREAM technology used to transmit fully digital audio between the congress units as well as between congress units and main unit(s)
- Audio signals processed by high performance DSP: sound quality approaching CD quality
- Gain and EQ (5 band) of each microphone adjustable separately, fitting the individual orator's voice to achieve perfect speech pickup any time
- Transmitting up to 64 CHs high quality digital audio signals on a dedicated 8-pin cable (general cat5e cable with a drain wire substitutable)
- Supports up to 64 (1+63) CHs simultaneous interpretation
- Supports 48 kHz audio sampling, and all 64 channels perfectly reproducing audio frequencies between 20 Hz and 20 kHz
- Integrated high-pass filter (low-cut switch) to cut low frequency elements from the audio when needed
- Automatic system recovery and “PnP” (plug and play)
- Stem microphone can be unplugged during adjournment, easy to maintain
- Mini-microphone, with foam windshield
- Hi-Fi loudspeaker, minimal feedback, mutes automatically when microphone is active
- Excellent immunity to RF interference from mobile phones and comparable devices
- Priority button
- Microphone On/Off button
- Braille is present for physical buttons
- An ID can be assigned by default or manually to each conference unit bearing a unique serial number for convenient maintenance
- Facilities in independent operation from computer:
 - ◆ Set the number of delegates permitted to speak at the same time
 - ◆ Speak mode: Open/Override/Voice/Request/PTT
 - “Open” mode, microphone On/Off button with request-to-speak registration (AUTO)
 - “Override” mode, microphone On/Off button control with override of the active microphones (FIFO)
 - “Voice” mode, acoustic active sensitivity and automatic switch-off time adjustable continuously, built-in “flash-on” technology, immediate microphone activation on speaking
 - “Request” mode, delegate requests to speak by pressing microphone On/Off button, delegate only speaks when operator or chairman approved his application
 - “PTT” mode, press microphone On/Off button to talk
 - ◆ Simultaneous interpretation
- Automatic video tracking implementation when cooperating with cameras & video switcher unit; preset positions on PC
- Activation at any time (if the amount of active microphones in the system is less than 8)

- Priority button to switch off or to mute the delegate units (except VIP units) according to preset
- Approves/denies delegates' speaking request
- System supports up to 100 chairman units, while all or part chairman units have the control facilities listed above (set by software or main unit)

Controls and Indicators

- Graphic 128x36 OLED for displaying Channel number and language name
- Built-in channel selector with channel selection function
- Uni-directional electret condenser microphone with bi-color illuminated ring
- Headphones volume control
- Microphone On/Off button with indicator
- Priority button with indicator

Interconnections

- Socket for pluggable microphone
- Ø 3.5 mm stereo headphone jack
- 1.5 m cable with 8P-DIN plug
- 0.6 m cable with 8P-DIN socket

Technical Specifications

Electrical

Max. consumption.....1.8 W

Headphone connection

Frequency response.....20 Hz to 20 kHz

Earphone load impedance.....>16 Ohm

Earphone output.....10 mW

Recommended microphone type

Transducer.....Electret-condenser

Polar pattern.....Uni-directional

Operating voltage.....5 VDC

Sensitivity.....-46 dBV/Pa

Frequency response.....50 Hz to 20 kHz

Input impedance.....2 kOhm

Directivity 0°/180°.....> 20 dB (1 kHz)

Equivalent noise.....20 dBA (SPL)

Maximum sound pressure level.....125 dB (THD<3%)

Interface data

Connector.....Ø 3.5 mm stereo jacks for headphones

Mechanical

Mounting.....Tabletop

Dimensions (h x w x d) (w/o stem microphone).....66 x 99 x 143 mm

Weight (incl. stem microphone).....0.9 kg

Color.....Charcoal gray (PANTONE Cool Gray 11 C)

Stem length.....330 mm, 410 mm (standard version), 470 mm

Ordering Information

HCS-4838CS/80.....Fully Digital Congress System
 Chairman Unit (tabletop, discussion, 64
 CHs, OLED, Braille, charcoal gray)

HCS-4838DS/80 Delegate Unit with Channel Selection



Features

- **Elegant and ergonomic design**
- **Exquisite and delicate tabletop design for ease of use and transport**
- **Cable coming out of the base for a tidier wiring**
- **Hi-Fi loudspeaker**
- **Request button**
- **Microphone On/Off button**
- **Braille is present for physical buttons**
- **Pluggable microphone**
- **OLED screen with high brightness and contrast, wide viewing angle and low power consumption**
- **“Closed Loop - Daisy Chain” connection topology**
- **Transmitting up to 64 CHs high quality digital audio signals on a dedicated 8-pin cable**
- **Supporting 48 kHz audio sampling rate, all 64 channels perfectly reproducing audio frequencies between 20 Hz and 20 kHz**
- **Excellent immunity to RF interference from mobile phones**
- **Separate adjustment of gain and EQ (5 band) of each microphone for the perfect sound**
- **Supporting “PnP” (plug and play)**

The multi-functional delegate unit meets the demands of even the largest conferences. It provides facilities for speaking, registering a request-to-speak, listening. Excellent immunity to RF interference from mobile phones. A graphic OLED screen can display operation menu, channel number and language name. Channel selection is automatically limited to the number of language channels available. The loudspeaker offers superior acoustics with minimal feedback for enhanced intelligibility.

Functions

- Compliant to ISO 22259
- “Closed Loop - Daisy Chain” connection topology for a high operational system reliability: breakdown or replacement of a congress unit and connection failure of a cable will not influence other congress units

- Based on TAIDEN originated MCA-STREAM digital audio processing and transmitting technologies
- Proprietary MCA-STREAM technology used to transmit fully digital audio between the congress units as well as between congress units and main unit(s)
- Audio signals processed by high performance DSP: sound quality approaching CD quality
- Gain and EQ (5 band) of each microphone adjustable separately, fitting the individual orator's voice to achieve perfect speech pickup any time
- Transmitting up to 64 CHs high quality digital audio signals on a dedicated 8-pin cable (general cat5e cable with a drain wire substitutable)
- Supports up to 64 (1+63) CHs simultaneous interpretation
- Supports 48 kHz audio sampling, and all 64 channels perfectly reproducing audio frequencies between 20 Hz and 20 kHz
- Integrated high-pass filter (low-cut switch) to cut low frequency elements from the audio when needed
- Automatic system recovery and “PnP” (plug and play)
- Stem microphone can be unplugged during adjournment, easy to maintain
- Mini-microphone, with foam windshield
- Hi-Fi loudspeaker, minimal feedback, mutes automatically when microphone is active
- Excellent immunity to RF interference from mobile phones and comparable devices
- Request button: the delegate can press the "Request" button to request to speak and his/her name will appear in the request list (effective in "Discussion" mode)
- Microphone On/Off button
- Braille is present for physical button
- An ID can be assigned by default or manually to each conference unit bearing a unique serial number for convenient maintenance
- Facilities in independent operation from computer:
 - ◆ Set the number of delegates permitted to speak at the same time
 - ◆ Speak mode: Open/Override/Voice/Request/PTT
 - "Open" mode, microphone On/Off button with request-to-speak registration (AUTO)
 - "Override" mode, microphone On/Off button control with override of the active microphones (FIFO)
 - "Voice" mode, acoustic active sensitivity and automatic switch-off time adjustable continuously, built-in "flash-on" technology, immediate microphone activation on speaking
 - "Request" mode, delegate requests to speak by pressing microphone On/Off button, delegate only speaks when operator or chairman approved his application
 - "PTT" mode, press microphone On/Off button to talk
 - ◆ Simultaneous interpretation
- Automatic video tracking implementation when cooperating with cameras & video switcher unit; preset positions on PC
- Set any delegate unit to be VIP unit
 - ◆ Up to 32 units can be set as VIP in one system via application software
 - ◆ VIP unit can be activated as long as the total of active microphones is not beyond 8 (incl. chairman/delegate/VIP unit)

Controls and Indicators

- Graphic 128x36 OLED for displaying Channel number and language name
- Built-in channel selector with channel selection function
- Uni-directional electret condenser microphone with bi-color illuminated ring
- Headphones volume control
- Microphone On/Off button with indicator
- Request button with indicator

Interconnections

- Socket for pluggable microphone
- Ø 3.5 mm stereo headphone jack
- 1.5 m cable with 8P-DIN plug
- 0.6 m cable with 8P-DIN socket

Technical Specifications

Electrical

Max. consumption.....1.8 W

Headphone connection

Frequency response.....20 Hz to 20 kHz

Earphone load impedance.....>16 Ohm

Earphone output.....10 mW

Recommended microphone type

Transducer.....Electret-condenser

Polar pattern.....Uni-directional

Operating voltage.....5 VDC

Sensitivity.....-46 dBV/Pa

Frequency response.....50 Hz to 20 kHz

Input impedance.....2 kOhm

Directivity 0°/180°.....> 20 dB (1 kHz)

Equivalent noise.....20 dBA (SPL)

Maximum sound pressure level.....125 dB (THD<3%)

Interface data

Connector.....Ø 3.5 mm stereo jacks for headphones

Mechanical

Mounting.....Tabletop

Dimensions (h x w x d) (w/o stem microphone).....66 x 99 x 143 mm

Weight (incl. stem microphone).....0.9 kg

Color.....Charcoal gray (PANTONE Cool Gray 11 C)

Stem length.....330 mm, 410 mm (standard version), 470 mm

Ordering Information

HCS-4838DS/80..... Fully Digital Congress System Delegate Unit (tabletop, discussion, 64 CHs, OLED, Braille, charcoal gray)

HCS-4838C Chairman Unit



Features

- **Elegant and ergonomic design**
- **Exquisite and delicate tabletop design for ease of use and transport**
- **Cable coming out of the base for a tidier wiring**
- **Hi-Fi loudspeaker**
- **Priority button**
- **Microphone On/Off button**
- **Braille is present for physical buttons**
- **Pluggable microphone**
- **“Closed Loop - Daisy Chain” connection topology**
- **Supporting 48 kHz audio sampling rate**
- **Excellent immunity to RF interference from mobile phones**
- **Separate adjustment of gain and EQ (5 band) of each microphone for the perfect sound**
- **Supporting “PnP” (plug and play)**

The stylish and ergonomically designed chairman unit has all the necessary facilities to enable the user to chair a conference. It has excellent immunity to RF interference from mobile phones. Similar in appearance to HCS-4838D Delegate Unit, the HCS-4838C Chairman Unit includes a microphone priority button. When pressed, the priority button causes all currently active delegate microphones to be switched off temporarily or permanently, allowing the chairman to take control of the meeting. The loudspeaker offers superior acoustics with minimal feedback for enhanced intelligibility.

Functions

- Compliant to ISO 22259
- “Closed Loop - Daisy Chain” connection topology for a high operational system reliability: breakdown or replacement of a congress unit and connection failure of a cable will not influence other congress units
- Based on TAIDEN originated MCA-STREAM digital audio processing and transmitting technologies
- Proprietary MCA-STREAM technology used to transmit fully digital audio between the congress units as well as between congress units and main unit(s)
- Audio signals processed by high performance DSP: sound quality approaching CD quality

- Gain and EQ (5 band) of each microphone adjustable separately, fitting the individual orator's voice to achieve perfect speech pickup any time
- Supporting 48 kHz audio sampling rate
- Integrated high-pass filter (low-cut switch) to cut low frequency elements from the audio when needed
- Automatic system recovery and “PnP” (plug and play)
- Stem microphone can be unplugged during adjournment, easy to maintain
- Mini-microphone, with foam windshield
- Hi-Fi loudspeaker, minimal feedback, mutes automatically when microphone is active
- Excellent immunity to RF interference from mobile phones and comparable devices
- Priority button
- Microphone On/Off button
- Braille is present for physical buttons
- An ID can be assigned by default or manually to each conference unit bearing a unique serial number for convenient maintenance
- Facilities in independent operation from computer:
 - ◆ Set the number of delegates permitted to speak at the same time
 - ◆ Speak mode: Open/Override/Voice/Request/PTT
 - “Open” mode, microphone On/Off button with request-to-speak registration (AUTO)
 - “Override” mode, microphone On/Off button control with override of the active microphones (FIFO)
 - “Voice” mode, acoustic active sensitivity and automatic switch-off time adjustable continuously, built-in “flash-on” technology, immediate microphone activation on speaking
 - “Request” mode, delegate requests to speak by pressing microphone On/Off button, delegate only speaks when operator or chairman approved his application
 - “PTT” mode, press microphone On/Off button to talk
- Automatic video tracking implementation when cooperating with cameras & video switcher unit; preset positions on PC
- Activation at any time (if the amount of active microphones in the system is less than 8)
- Priority button to switch off or to mute the delegate units (except VIP units) according to preset
- Approves/denies delegates' speaking request
- System supports up to 100 chairman units, while all or part chairman units have the control facilities listed above (set by software or main unit)

Controls and Indicators

- Uni-directional electret condenser microphone with bi-color illuminated ring
- Headphones volume control
- Microphone On/Off button with indicator
- Priority button with indicator

Interconnections

- Socket for pluggable microphone
- Ø 3.5 mm stereo headphone jacks
- 1.5 m cable with 8P-DIN plug
- 0.6 m cable with 8P-DIN socket

Technical Specifications

Electrical

Max. consumption.....1.8 W

Headphone connection

Frequency response.....20 Hz to 20 kHz

Earphone load impedance.....>16 Ohm

Earphone output.....10 mW

Recommended microphone type

Transducer.....Electret-condenser

Polar pattern.....Uni-directional

Operating voltage.....5 VDC

Sensitivity.....-46 dBV/Pa

Frequency response.....50 Hz to 20 kHz

Input impedance.....2 kOhm

Directivity 0°/180°.....> 20 dB (1 kHz)

Equivalent noise.....20 dBA (SPL)

Maximum sound pressure level.....125 dB (THD<3%)

Interface data

Connector.....Ø 3.5 mm stereo jacks for headphone

Mechanical

Mounting.....Tabletop

Dimensions (h x w x d) (w/o stem microphone).....66 x 99 x 143 mm

Weight (incl. stem microphone).....0.9 kg

Color.....Charcoal gray (PANTONE Cool Gray 11 C)

Stem length.....330 mm, 410 mm (standard version), 470 mm

Ordering Information

HCS-4838C.....Fully Digital Congress System Chairman Unit
(tabletop, discussion, Braille, charcoal gray)

HCS-4838D Delegate Unit



Features

- **Elegant and ergonomic design**
- **Exquisite and delicate tabletop design for ease of use and transport**
- **Cable coming out of the base for a tidier wiring**
- **Hi-Fi loudspeaker**
- **Microphone On/Off button**
- **Braille is present for physical buttons**
- **Pluggable microphone**
- **“Closed Loop - Daisy Chain” connection topology**
- **Supporting 48 kHz audio sampling rate**
- **Excellent immunity to RF interference from mobile phones**
- **Separate adjustment of gain and EQ (5 band) of each microphone for the perfect sound**
- **Supporting “PnP” (plug and play)**

The multi-functional delegate unit meets the demands of even the largest conferences. It provides facilities for speaking, registering a request-to-speak, listening. Excellent immunity to RF interference from mobile phones. The loudspeaker offers superior acoustics with minimal feedback for enhanced intelligibility.

Functions

- Compliant to ISO 22259
- “Closed Loop - Daisy Chain” connection topology for a high operational system reliability: breakdown or replacement of a congress unit and connection failure of a cable will not influence other congress units
- Based on TAIDEN originated MCA-STREAM digital audio processing and transmitting technologies
- Proprietary MCA-STREAM technology used to transmit fully digital audio between the congress units as well as between congress units and main unit(s)
- Audio signals processed by high performance DSP: sound quality approaching CD quality
- Gain and EQ (5 band) of each microphone adjustable separately, fitting the individual orator’s voice to achieve perfect speech pickup any time
- Supporting 48 kHz audio sampling rate
- Integrated high-pass filter (low-cut switch) to cut low frequency elements from the audio when needed

- Automatic system recovery and “PnP” (plug and play)
- Stem microphone can be unplugged during adjournment, easy to maintain
- Mini-microphone, with foam windshield
- Hi-Fi loudspeaker, minimal feedback, mutes automatically when microphone is active
- Excellent immunity to RF interference from mobile phones and comparable devices
- Microphone On/Off button
- Braille is present for physical button
- An ID can be assigned by default or manually to each conference unit bearing a unique serial number for convenient maintenance
- Facilities in independent operation from computer:
 - ◆ Set the number of delegates permitted to speak at the same time
 - ◆ Speak mode: Open/Override/Voice/Request/PTT
 - “Open” mode, microphone On/Off button with request-to-speak registration (AUTO)
 - “Override” mode, microphone On/Off button control with override of the active microphones (FIFO)
 - “Voice” mode, acoustic active sensitivity and automatic switch-off time adjustable continuously, built-in “flash-on” technology, immediate microphone activation on speaking
 - “Request” mode, delegate requests to speak by pressing microphone On/Off button, delegate only speaks when operator or chairman approved his application
 - “PTT” mode, press microphone On/Off button to talk
- Automatic video tracking implementation when cooperating with cameras & video switcher unit; preset positions on PC
- Set any delegate unit to be VIP unit
 - ◆ Up to 32 units can be set as VIP in one system via application software
 - ◆ VIP unit can be activated as long as the total of active microphones is not beyond 8 (incl. chairman/delegate/VIP unit)

Controls and Indicators

- Uni-directional electret condenser microphone with bi-color illuminated ring
- Headphones volume control
- Microphone On/Off button with indicator

Interconnections

- Socket for pluggable microphone
- Ø 3.5 mm stereo headphone jack
- 1.5 m cable with 8P-DIN plug
- 0.6 m cable with 8P-DIN socket

Technical Specifications

Electrical

Max. consumption.....1.8 W

Headphone connection

Frequency response.....20 Hz to 20 kHz

Earphone load impedance.....>16 Ohm

Earphone output.....10 mW

Recommended microphone type

Transducer..... Electret-condenser
 Polar pattern..... Uni-directional
 Operating voltage..... 5 VDC
 Sensitivity..... -46 dBV/Pa
 Frequency response..... 50 Hz to 20 kHz
 Input impedance..... 2 kOhm
 Directivity 0°/180°..... > 20 dB (1 kHz)
 Equivalent noise..... 20 dBA (SPL)
 Maximum sound pressure level..... 125 dB (THD<3%)

Interface data

Connector..... ∅ 3.5 mm stereo jacks for headphones

Mechanical

Mounting..... Tabletop
 Dimensions (h x w x d) (w/o stem microphone)..... 66 x 99 x 143 mm
 Weight (incl. stem microphone)..... 0.9 kg
 Color..... Charcoal gray (PANTONE Cool Gray 11 C)
 Stem length..... 330 mm, 410 mm (standard version), 470 mm

Ordering Information

HCS-4838D..... Fully Digital Congress System Delegate Unit
 (tabletop, discussion, Braille, charcoal gray)

Function list

Model No.	Type	Speech	SI	Main unit	Cable
HCS-4838CS/80	Chairman	√	64CHs	HCS-4800MA/20	8-pin dedicated cable
HCS-4838DS/80	Delegate	√	64CHs		
HCS-4838C	Chairman	√		HCS-4800M Series	
HCS-4838D	Delegate	√			

HCS-4838RCS/80 Chairman Unit with Channel Selection



Features

- **Elegant and ergonomic design**
- **Exquisite and delicate tabletop design for ease of use and transport**
- **Cable coming out of the base for a tidier wiring**
- **Hi-Fi loudspeaker**
- **Priority button**
- **Microphone On/Off button**
- **Braille is present for physical buttons**
- **Rectangular columnar microphone, the pitching angle of the microphone is adjustable**
- **OLED screen with high brightness and contrast, wide viewing angle and low power consumption**
- **“Closed Loop - Daisy Chain” connection topology**
- **Transmitting up to 64 CHs high quality digital audio signals on a dedicated 8-pin cable**
- **Supporting 48 kHz audio sampling rate, all 64 channels perfectly reproducing audio frequencies between 20 Hz and 20 kHz**
- **Excellent immunity to RF interference from mobile phones**
- **Separate adjustment of gain and EQ (5 band) of each microphone for the perfect sound**
- **Supporting “PnP” (plug and play)**

The stylish and ergonomically designed chairman unit has all the necessary facilities to enable the user to chair a conference. It has excellent immunity to RF interference from mobile phones. Similar in appearance to HCS-4838RDS Delegate Unit, the HCS-4838RCS Chairman Unit includes a microphone priority button. When pressed, the priority button causes all currently active delegate microphones to be switched off temporarily or permanently, allowing the chairman to take control of the meeting. A graphic OLED can display channel number and language name. Channel selection is automatically limited to the number of language channels available.

The loudspeaker offers superior acoustics with minimal feedback for enhanced intelligibility.

Functions

- Compliant to ISO 22259
- “Closed Loop - Daisy Chain” connection topology for a high operational system reliability: breakdown or replacement of a congress unit and connection failure of a cable will not influence other congress units
- Based on TAIDEN originated MCA-STREAM digital audio processing and transmitting technologies
- Proprietary MCA-STREAM technology used to transmit fully digital audio between the congress units as well as between congress units and main unit(s)
- Audio signals processed by high performance DSP: sound quality approaching CD quality
- Hypercardioid uni-directional electret condenser microphone with bi-color illuminated ring
- Rectangular columnar microphone, the pitching angle of the microphone is adjustable
- Gain and EQ (5 band) of each microphone adjustable separately, fitting the individual orator’s voice to achieve perfect speech pickup any time
- Transmitting up to 64 CHs high quality digital audio signals on a dedicated 8-pin cable (general cat5e cable with a drain wire substitutable)
- Supports up to 64 (1+63) CHs simultaneous interpretation
- Supports 48 kHz audio sampling, and all 64 channels perfectly reproducing audio frequencies between 20 Hz and 20 kHz
- Integrated high-pass filter (low-cut switch) to cut low frequency elements from the audio when needed
- Automatic system recovery and “PnP” (plug and play)
- Hi-Fi loudspeaker, minimal feedback, mutes automatically when microphone is active
- Excellent immunity to RF interference from mobile phones and comparable devices
- Priority button
- Microphone On/Off button
- Braille is present for physical buttons
- An ID can be assigned by default or manually to each conference unit bearing a unique serial number for convenient maintenance
- Facilities in independent operation from computer:
 - ◆ Set the number of delegates permitted to speak at the same time
 - ◆ Speak mode: Open/Override/Voice/Request/PTT
 - “Open” mode, microphone On/Off button with request-to-speak registration (AUTO)
 - “Override” mode, microphone On/Off button control with override of the active microphones (FIFO)
 - “Voice” mode, acoustic active sensitivity and automatic switch-off time adjustable continuously, built-in “flash-on” technology, immediate microphone activation on speaking
 - “Request” mode, delegate requests to speak by pressing microphone On/Off button, delegate only speaks when operator or chairman approved his application
 - “PTT” mode, press microphone On/Off button to talk
 - ◆ Simultaneous interpretation
- Automatic video tracking implementation when cooperating with cameras & video switcher unit; preset positions on PC

- Activation at any time (if the amount of active microphones in the system is less than 8)
- Priority button to switch off or to mute the delegate units (except VIP units) according to preset
- Approves/denies delegates' speaking request
- System supports up to 100 chairman units, while all or part chairman units have the control facilities listed above (set by software or main unit)

Controls and Indicators

- Graphic 128x36 OLED for displaying Channel number and language name
- Built-in channel selector with channel selection function
- Hypercardioid uni-directional electret condenser microphone with bi-color illuminated ring
- Headphones volume control
- Microphone On/Off button with indicator
- Priority button with indicator

Interconnections

- Ø 3.5 mm stereo headphone jack
- 1.5 m cable with 8P-DIN plug
- 0.6 m cable with 8P-DIN socket

Technical Specifications

Electrical

Max. consumption.....1.8 W

Headphone connection

Frequency response.....20 Hz to 20 kHz

Earphone load impedance.....>16 Ohm

Earphone output.....10 mW

Recommended microphone type

Transducer.....Electret-condenser

Polar pattern.....Hypercardioid uni-directional
.....14mm gold-plating capacitance sound head

Operating voltage.....5 VDC

Sensitivity.....-37 dBV/Pa

Frequency response.....20 Hz to 20 kHz

Input impedance.....2 kOhm

Directivity 0°/135°.....> 20 dB (1 kHz)

Directivity 0°/180°.....> 15 dB (1 kHz)

Equivalent noise.....20 dBA (SPL)

Maximum sound pressure level.....139 dB (THD<3%)

Interface data

Connector.....Ø 3.5 mm stereo jacks for headphones

Mechanical

Mounting.....Tabletop

Dimensions (h x w x d).....66 x 99 x 143 mm (base)

.....37 x 37 x 241 mm (microphone)

Weight1.4 kg

Color.....Black (PANTONE 419 C) microphone +
.....Charcoal gray (PANTONE Cool Gray 11 C)

Ordering Information

HCS-4838RCS/80.....Fully Digital Congress System

Chairman Unit(tabletop, discussion, 64 CHs, OLED, rectangular columnar metal microphone, Braille, black,

HCS-4838RDS/80 Delegate Unit with Channel Selection



Features

- Elegant and ergonomic design
- Exquisite and delicate tabletop design for ease of use and transport
- Cable coming out of the base for a tidier wiring
- Hi-Fi loudspeaker
- Request button
- Microphone On/Off button
- Braille is present for physical buttons
- Rectangular columnar microphone, the pitching angle of the microphone is adjustable
- OLED screen with high brightness and contrast, wide viewing angle and low power consumption
- "Closed Loop - Daisy Chain" connection topology
- Transmitting up to 64 CHs high quality digital audio signals on a dedicated 8-pin cable
- Supporting 48 kHz audio sampling rate, all 64 channels perfectly reproducing audio frequencies between 20 Hz and 20 kHz
- Excellent immunity to RF interference from mobile phones
- Separate adjustment of gain and EQ (5 band) of each microphone for the perfect sound
- Supporting "PnP" (plug and play)

The multi-functional delegate unit meets the demands of even the largest conferences. It provides facilities for speaking, registering a request-to-speak, listening. Excellent immunity to RF interference from mobile phones. A graphic OLED screen can display operation menu, channel number and language name. Channel selection is automatically limited to the number of language channels available. The loudspeaker offers superior acoustics with minimal feedback for enhanced intelligibility.

Functions

- Compliant to ISO 22259
- "Closed Loop - Daisy Chain" connection topology for a high operational system reliability: breakdown or replacement of a congress unit and connection failure of a cable will not influence other congress units
- Based on TAIDEN originated MCA-STREAM digital audio processing and transmitting technologies

- Proprietary MCA-STREAM technology used to transmit fully digital audio between the congress units as well as between congress units and main unit(s)
- Audio signals processed by high performance DSP: sound quality approaching CD quality
- Hypercardioid uni-directional electret condenser microphone with bi-color illuminated ring
- Rectangular columnar microphone, the pitching angle of the microphone is adjustable
- Gain and EQ (5 band) of each microphone adjustable separately, fitting the individual orator's voice to achieve perfect speech pickup any time
- Transmitting up to 64 CHs high quality digital audio signals on a dedicated 8-pin cable (general cat5e cable with a drain wire substitutable)
- Supports up to 64 (1+63) CHs simultaneous interpretation
- Supports 48 kHz audio sampling, and all 64 channels perfectly reproducing audio frequencies between 20 Hz and 20 kHz
- Integrated high-pass filter (low-cut switch) to cut low frequency elements from the audio when needed
- Automatic system recovery and "PnP" (plug and play)
- Hi-Fi loudspeaker, minimal feedback, mutes automatically when microphone is active
- Excellent immunity to RF interference from mobile phones and comparable devices
- Request button: the delegate can press the "Request" button to request to speak and his/her name will appear in the request list (effective in "Discussion" mode)
- Microphone On/Off button
- Braille is present for physical button
- An ID can be assigned by default or manually to each conference unit bearing a unique serial number for convenient maintenance
- Facilities in independent operation from computer:
 - ◆ Set the number of delegates permitted to speak at the same time
 - ◆ Speak mode: Open/Override/Voice/Request/PTT
 - "Open" mode, microphone On/Off button with request-to-speak registration (AUTO)
 - "Override" mode, microphone On/Off button control with override of the active microphones (FIFO)
 - "Voice" mode, acoustic active sensitivity and automatic switch-off time adjustable continuously, built-in "flash-on" technology, immediate microphone activation on speaking
 - "Request" mode, delegate requests to speak by pressing microphone On/Off button, delegate only speaks when operator or chairman approved his application
 - "PTT" mode, press microphone On/Off button to talk
 - ◆ Simultaneous interpretation
- Automatic video tracking implementation when cooperating with cameras & video switcher unit; preset positions on PC
- Set any delegate unit to be VIP unit
 - ◆ Up to 32 units can be set as VIP in one system via application software
 - ◆ VIP unit can be activated as long as the total of active microphones is not beyond 8 (incl. chairman/delegate/VIP unit)

Controls and Indicators

- Graphic 128x36 OLED for displaying Channel number and language name
- Built-in channel selector with channel selection function
- Hypercardioid uni-directional electret condenser microphone with bi-color illuminated ring
- Headphones volume control
- Microphone On/Off button with indicator
- Request button with indicator

Interconnections

- Ø 3.5 mm stereo headphone jack
- 1.5 m cable with 8P-DIN plug
- 0.6 m cable with 8P-DIN socket

Technical Specifications

Electrical

Max. consumption.....1.8 W

Headphone connection

Frequency response.....20 Hz to 20 kHz

Earphone load impedance.....>16 Ohm

Earphone output.....10 mW

Recommended microphone type

Transducer.....Electret-condenser

Polar pattern.....Hypercardioid uni-directional

.....14mm gold-plating capacitance sound head

Operating voltage.....5 VDC

Sensitivity.....-37 dBV/Pa

Frequency response.....20 Hz to 20 kHz

Input impedance.....2 kOhm

Directivity 0°/135°.....> 20 dB (1 kHz)

Directivity 0°/180°.....> 15 dB (1 kHz)

Equivalent noise.....20 dBA (SPL)

Maximum sound pressure level.....139 dB (THD<3%)

Interface data

Connector.....Ø 3.5 mm stereo jacks for headphones

Mechanical

Mounting.....Tabletop

Dimensions (h x w x d).....66 x 99 x 143 mm (base)

.....37 x 37 x 241 mm (microphone)

Weight.....1.4 kg

Color.....Black (PANTONE 419 C) microphone +

Charcoal gray (PANTONE Cool Gray 11 C)

Ordering Information

HCS-4838RDS/80..... Fully Digital Congress System Delegate
Unit(tabletop, discussion, 64 CHs, OLED,
rectangular columnar metal microphone,
Braille, black microphone +charcoal gray base)

HCS-4838RC Chairman Unit



Features

- **Elegant and ergonomic design**
- **Exquisite and delicate tabletop design for ease of use and transport**
- **Cable coming out of the base for a tidier wiring**
- **Hi-Fi loudspeaker**
- **Priority button**
- **Microphone On/Off button**
- **Braille is present for physical buttons**
- **Rectangular columnar microphone, the pitching angle of the microphone is adjustable**
- **“Closed Loop - Daisy Chain” connection topology**
- **Supporting 48 kHz audio sampling rate**
- **Excellent immunity to RF interference from mobile phones**
- **Separate adjustment of gain and EQ (5 band) of each microphone for the perfect sound**
- **Supporting “PnP” (plug and play)**

The stylish and ergonomically designed chairman unit has all the necessary facilities to enable the user to chair a conference. It has excellent immunity to RF interference from mobile phones. Similar in appearance to HCS-4838RD Delegate Unit, the HCS-4838RC Chairman Unit includes a microphone priority button. When pressed, the priority button causes all currently active delegate microphones to be switched off temporarily or permanently, allowing the chairman to take control of the meeting. The loudspeaker offers superior acoustics with minimal feedback for enhanced intelligibility.

Functions

- Compliant to ISO 22259
- “Closed Loop - Daisy Chain” connection topology for a high operational system reliability: breakdown or replacement of a congress unit and connection failure of a cable will not influence other congress units
- Based on TAIDEN originated MCA-STREAM digital audio processing and transmitting technologies
- Proprietary MCA-STREAM technology used to transmit fully digital audio between the congress units as well as between congress units and main unit(s)
- Audio signals processed by high performance DSP: sound quality approaching CD quality

- Hypercardioid uni-directional electret condenser microphone with bi-color illuminated ring
- Rectangular columnar microphone, the pitching angle of the microphone is adjustable
- Gain and EQ (5 band) of each microphone adjustable separately, fitting the individual orator’s voice to achieve perfect speech pickup any time
- Supporting 48 kHz audio sampling rate
- Integrated high-pass filter (low-cut switch) to cut low frequency elements from the audio when needed
- Automatic system recovery and “PnP” (plug and play)
- Hi-Fi loudspeaker, minimal feedback, mutes automatically when microphone is active
- Excellent immunity to RF interference from mobile phones and comparable devices
- Priority button
- Microphone On/Off button
- Braille is present for physical buttons
- An ID can be assigned by default or manually to each conference unit bearing a unique serial number for convenient maintenance
- Facilities in independent operation from computer:
 - ◆ Set the number of delegates permitted to speak at the same time
 - ◆ Speak mode: Open/Override/Voice/Request/PTT
 - “Open” mode, microphone On/Off button with request-to-speak registration (AUTO)
 - “Override” mode, microphone On/Off button control with override of the active microphones (FIFO)
 - “Voice” mode, acoustic active sensitivity and automatic switch-off time adjustable continuously, built-in “flash-on” technology, immediate microphone activation on speaking
 - “Request” mode, delegate requests to speak by pressing microphone On/Off button, delegate only speaks when operator or chairman approved his application
 - “PTT” mode, press microphone On/Off button to talk
- Automatic video tracking implementation when cooperating with cameras & video switcher unit; preset positions on PC
- Activation at any time (if the amount of active microphones in the system is less than 8)
- Priority button to switch off or to mute the delegate units (except VIP units) according to preset
- Approves/denies delegates’ speaking request
- System supports up to 100 chairman units, while all or part chairman units have the control facilities listed above (set by software or main unit)

Controls and Indicators

- Hypercardioid uni-directional electret condenser microphone with bi-color illuminated ring
- Headphones volume control
- Microphone On/Off button with indicator
- Priority button with indicator

Interconnections

- Ø 3.5 mm stereo headphone jack
- 1.5 m cable with 8P-DIN plug
- 0.6 m cable with 8P-DIN socket

Technical Specifications

Electrical

Max. consumption.....1.8 W

Headphone connection

Frequency response.....20 Hz to 20 kHz

Earphone load impedance.....>16 Ohm

Earphone output.....10 mW

Recommended microphone type

Transducer.....Electret-condenser

Polar pattern.....Hypercardioid uni-directional
.....14mm gold-plating capacitance sound head

Operating voltage.....5 VDC

Sensitivity.....-37 dBV/Pa

Frequency response.....20 Hz to 20 kHz

Input impedance.....2 kOhm

Directivity 0°/135°.....> 20 dB (1 kHz)

Directivity 0°/180°.....> 15 dB (1 kHz)

Equivalent noise.....20 dBA (SPL)

Maximum sound pressure level.....139 dB (THD<3%)

Interface data

Connector.....Ø 3.5 mm stereo jacks for headphones

Mechanical

Mounting.....Tabletop

Dimensions (h x w x d).....66 x 99 x 143 mm (base)

.....37 x 37 x 241 mm (microphone)

Weight.....1.4 kg

Color.....Black (PANTONE 419 C) microphone +
.....Charcoal gray (PANTONE Cool Gray 11 C)

Ordering Information

HCS-4838RC.....Fully Digital Congress System Chairman Unit
(tabletop, discussion, rectangular columnar metal microphone,
Braille, black microphone +charcoal gray base)

HCS-4838RD Delegate Unit



Features

- **Elegant and ergonomic design**
- **Exquisite and delicate tabletop design for ease of use and transport**
- **Cable coming out of the base for a tidier wiring**
- **Hi-Fi loudspeaker**
- **Microphone On/Off button**
- **Braille is present for physical buttons**
- **Rectangular columnar microphone, the pitching angle of the microphone is adjustable**
- **“Closed Loop - Daisy Chain” connection topology**
- **Supporting 48 kHz audio sampling rate**
- **Excellent immunity to RF interference from mobile phones**
- **Separate adjustment of gain and EQ (5 band) of each microphone for the perfect sound**
- **Supporting “PnP” (plug and play)**

The multi-functional delegate unit meets the demands of even the largest conferences. It provides facilities for speaking, registering a request-to-speak, listening. Excellent immunity to RF interference from mobile phones. The loudspeaker offers superior acoustics with minimal feedback for enhanced intelligibility.

Functions

- Compliant to ISO 22259
- “Closed Loop - Daisy Chain” connection topology for a high operational system reliability: breakdown or replacement of a congress unit and connection failure of a cable will not influence other congress units
- Based on TAIDEN originated MCA-STREAM digital audio processing and transmitting technologies
- Proprietary MCA-STREAM technology used to transmit fully digital audio between the congress units as well as between congress units and main unit(s)
- Audio signals processed by high performance DSP: sound quality approaching CD quality
- Hypercardioid uni-directional electret condenser microphone with bi-color illuminated ring
- Rectangular columnar microphone, the pitching angle of the microphone is adjustable
- Gain and EQ (5 band) of each microphone adjustable separately, fitting the individual orator’s voice to achieve perfect

- speech pickup any time
- Supporting 48 kHz audio sampling rate
- Integrated high-pass filter (low-cut switch) to cut low frequency elements from the audio when needed
- Automatic system recovery and “PnP” (plug and play)
- Hi-Fi loudspeaker, minimal feedback, mutes automatically when microphone is active
- Excellent immunity to RF interference from mobile phones and comparable devices
- Microphone On/Off button
- Braille is present for physical button
- An ID can be assigned by default or manually to each conference unit bearing a unique serial number for convenient maintenance
- Facilities in independent operation from computer:
 - ◆ Set the number of delegates permitted to speak at the same time
 - ◆ Speak mode: Open/Override/Voice/Request/PTT
 - “Open” mode, microphone On/Off button with request-to-speak registration (AUTO)
 - “Override” mode, microphone On/Off button control with override of the active microphones (FIFO)
 - “Voice” mode, acoustic active sensitivity and automatic switch-off time adjustable continuously, built-in “flash-on” technology, immediate microphone activation on speaking
 - “Request” mode, delegate requests to speak by pressing microphone On/Off button, delegate only speaks when operator or chairman approved his application
 - “PTT” mode, press microphone On/Off button to talk
- Automatic video tracking implementation when cooperating with cameras & video switcher unit; preset positions on PC
- Set any delegate unit to be VIP unit
 - ◆ Up to 32 units can be set as VIP in one system via application software
 - ◆ VIP unit can be activated as long as the total of active microphones is not beyond 8 (incl. chairman/delegate/VIP unit)

Controls and Indicators

- Hypercardioid uni-directional electret condenser microphone with bi-color illuminated ring
- Headphones volume control
- Microphone On/Off button with indicator

Interconnections

- Ø 3.5 mm stereo headphone jack
- 1.5 m cable with 8P-DIN plug
- 0.6 m cable with 8P-DIN socket

Technical Specifications

Electrical

Max. consumption.....1.8 W

Headphone connection

Frequency response.....20 Hz to 20 kHz

Earphone load impedance.....>16 Ohm

Earphone output.....10 mW

Recommended microphone type

Transducer..... Electret-condenser
 Polar pattern..... Hypercardioid uni-directional
14mm gold-plating capacitance sound head
 Operating voltage..... 5 VDC
 Sensitivity..... -37 dBV/Pa
 Frequency response..... 20 Hz to 20 kHz
 Input impedance..... 2 kOhm
 Directivity 0°/135°..... > 20 dB (1 kHz)
 Directivity 0°/180°..... > 15 dB (1 kHz)
 Equivalent noise..... 20 dBA (SPL)
 Maximum sound pressure level..... 139 dB (THD<3%)

Interface data

Connector..... Ø 3.5 mm stereo jacks for headphones

Mechanical

Mounting..... Tabletop
 Dimensions (h x w x d)..... 66 x 99 x 143mm (base)
 37 x 37 x 241 mm (microphone)
 Weight..... 1.4 kg
 Color..... Black (PANTONE 419 C) microphone +
 Charcoal gray (PANTONE Cool Gray 11 C)

Ordering Information

HCS-4838RD..... Fully Digital Congress System Delegate Unit
 (tabletop, discussion, rectangular columnar metal microphone,
 Braille, black microphone +charcoal gray base)

Function list

Model No.	Type	Speech	SI	Main unit	Cable
HCS-4838RCS/80	Chairman	√	64CHs	HCS-4800MA/20	8-pin dedicated cable
HCS-4838RDS/80	Delegate	√	64CHs		
HCS-4838RC	Chairman	√		HCS-4800M Series	
HCS-4838RD	Delegate	√			

HCS-48U6CMICM/80 Chairman Unit



Features

- Flush-mounting, elegant and ergonomic design
- Pluggable microphone
- Priority button
- Supporting 48 kHz audio sampling rate
- Excellent immunity to RF interference from mobile phones
- Separate adjustment of gain and EQ (5 band) of each microphone for the perfect sound
- Supporting "PnP" (plug and play)

The stylish and ergonomically designed chairman unit has the necessary facilities to enable the user to chair a conference. It has excellent immunity to RF interference from mobile phones. Similar in appearance to HCS-48U6DMICM/80 Delegate Unit, the HCS-48U6CMICM/80 Chairman Unit includes a microphone priority button. When pressed, the priority button causes all currently active delegate microphones to be switched off temporarily or permanently, allowing the chairman to take control of the meeting. HCS-48U6CMICM/80 Chairman Unit can connect to HCS-48U6VOT voting unit and HCS-48U6SPK loudspeaker.

Functions

- Compliant to ISO 22259
- Based on TAIDEN originated MCA-STREAM digital audio processing and transmitting technologies
- Proprietary MCA-STREAM technology used to transmit fully digital audio between the congress units as well as between congress units and main unit(s)
- Audio signals processed by high performance DSP: sound quality approaching CD quality
- Gain and EQ (5 band) of each microphone adjustable separately, fitting the individual orator's voice to achieve perfect speech pickup any time
- Supporting 48 kHz audio sampling rate
- Integrated high-pass filter (low-cut switch) to cut low frequency elements from the audio when needed
- Automatic system recovery and "PnP" (plug and play)
- Stem microphone can be unplugged during adjournment, easy to maintain

- Mini-microphone, built-in foam windshield
- Excellent immunity to RF interference from mobile phones and comparable devices
- Microphone On/Off button
- An ID can be assigned by default or manually to each conference unit bearing a unique serial number for convenient maintenance
- Facilities in independent operation from computer:
 - ◆ Set the number of delegates permitted to speak at the same time
 - ◆ Speak mode: Open/Override/Voice/Request/PTT
 - "Open" mode, microphone On/Off button with request-to-speak registration (AUTO)
 - "Override" mode, microphone On/Off button control with override of the active microphones (FIFO)
 - "Voice" mode, acoustic active sensitivity and automatic switch-off time adjustable continuously, built-in "flash-on" technology, immediate microphone activation on speaking
 - "Request" mode, delegate requests to speak by pressing microphone On/Off button, delegate only speaks when operator or chairman approved his application
 - "PTT" mode, press microphone On/Off button to talk
- Automatic video tracking implementation when cooperating with cameras & video switcher unit; preset positions on PC
- Activation at any time (if the amount of active microphones in the system is less than 8)
- Priority button to switch off or to mute the delegate units (except VIP units) according to preset
- Approves/denies delegates' speaking request
- System supports up to 100 chairman units, while all or part chairman units have the control facilities listed above (set by software or main unit)

Controls and Indicators

- Uni-directional electret condenser microphone with illuminated ring
- Microphone On/Off button with indicator
- Priority button

Interconnections

- Socket for pluggable microphone
- Ø 3.5 mm socket for HCS-48U6SPK
- RJ11 socket for HCS-48U6VOT
- 2 × RJ45 socket for daisy chain connection (recommended use of cat5e cable with a drain wire & RJ45 plug with metal shield)

Technical Specifications

Electrical

Max. consumption.....1.8 W

Recommended microphone type

Transducer.....Electret-condenser

Polar pattern.....Uni-directional

Operating voltage.....5 VDC

Sensitivity.....-46 dBV/Pa

Frequency response.....50 Hz to 20 kHz

Input impedance.....2 kOhm

Directivity 0°/180°.....> 20 dB (1 kHz)

Equivalent noise.....20 dBA (SPL)

Maximum sound pressure level..... 125 dB (THD<3%)

Mechanical

Mounting..... Flush-mounting

Dimensions (h x w x d) (w/o stem microphone)..... 71 x 100 x 40 mm

Weight (incl. stem microphone)..... 0.5 kg

Color..... Black (PANTONE 419 C)

Stem length..... 330 mm, 410 mm (standard version), 470 mm

Ordering Information

HCS-48U6MICM/80.... Fully Digital Congress System Chairman
Unit (flush-mounting, discussion,
HCS-48U6VOT and HCS-48U6SPK can
be connected, black)

HCS-48U6DMICM/80 Delegate Unit



Features

- Flush-mounting, elegant and ergonomic design
- Pluggable microphone
- Supporting 48 kHz audio sampling rate
- Excellent immunity to RF interference from mobile phones
- Separate adjustment of gain and EQ (5 band) of each microphone for the perfect sound
- Supporting "PnP" (plug and play)

HCS-48U6DMICM/80 Delegate Unit meets the basic demands of the most conferences. It provides facilities for speaking and registering a request-to-speak. It can connect to HCS-48U6VOT voting unit and HCS-48U6SPK loudspeaker.

Functions

- Compliant to ISO 22259
- Based on TAIDEN originated MCA-STREAM digital audio processing and transmitting technologies
- Proprietary MCA-STREAM technology used to transmit fully digital audio between the congress units as well as between congress units and main unit(s)
- Audio signals processed by high performance DSP: sound quality approaching CD quality
- Gain and EQ (5 band) of each microphone adjustable separately, fitting the individual orator's voice to achieve perfect speech pickup any time.
- Supporting 48 kHz audio sampling rate
- Integrated high-pass filter (low-cut switch) to cut low frequency elements from the audio when needed
- Automatic system recovery and "PnP" (plug and play)
- Stem microphone can be unplugged during adjournment, easy to maintain
- Mini-microphone, built-in foam windshield
- Excellent immunity to RF interference from mobile phones and comparable devices
- Microphone On/Off button
- An ID can be assigned by default or manually to each conference unit bearing a unique serial number for convenient maintenance

- Facilities in independent operation from computer:
 - ◆ Set the number of delegates permitted to speak at the same time
 - ◆ Speak mode: Open/Override/Voice/Request/PTT
 - "Open" mode, microphone On/Off button with request-to-speak registration (AUTO)
 - "Override" mode, microphone On/Off button control with override of the active microphones (FIFO)
 - "Voice" mode, acoustic active sensitivity and automatic switch-off time adjustable continuously, built-in "flash-on" technology, immediate microphone activation on speaking
 - "Request" mode, delegate requests to speak by pressing microphone On/Off button, delegate only speaks when operator or chairman approved his application
 - "PTT" mode, press microphone On/Off button to talk
- Automatic video tracking implementation when cooperating with cameras & video switcher unit; preset positions on PC
- Set any delegate unit to be VIP unit
 - ◆ Up to 32 units can be set as VIP in one system via application software
 - ◆ VIP unit can be activated as long as the total of active microphones is not beyond 8 (incl. chairman/delegate/VIP unit)

Controls and Indicators

- Uni-directional electret condenser microphone with illuminated ring
- Microphone On/Off button with indicator

Interconnections

- Socket for pluggable microphone
- Ø 3.5 mm socket for HCS-48U6SPK
- RJ11 socket for HCS-48U6VOT
- 2 × RJ45 socket for daisy chain connection (recommended use of cat5e cable with a drain wire & RJ45 plug with metal shield)

Technical Specifications

Electrical

Max. consumption 1.8 W

Recommended microphone type

Transducer Electret-condenser
 Polar pattern Uni-directional
 Operating voltage 5 VDC
 Sensitivity -46 dBV/Pa
 Frequency response 50 Hz to 20 kHz
 Input impedance 2 kOhm
 Directivity 0°/180° > 20 dB (1 kHz)
 Equivalent noise 20 dBA (SPL)
 Maximum sound pressure level 125 dB (THD<3%)

Mechanical

Mounting Flush-mounting
 Dimensions (h x w x d) (w/o stem microphone) 71 x 100 x 40 mm
 Weight (incl. stem microphone) 0.5 kg
 Color Black (PANTONE 419 C)
 Stem length 330 mm, 410 mm (standard version), 470 mm

Ordering Information

HCS-48U6DMICM/80.....Fully Digital Congress System Delegate
Unit (flush-mounting, discussion,
HCS-48U6VOT and HCS-48U6SPK can
be connected, black)

HCS-48U6CMICS Chairman Unit



Features

- Flush-mounting, elegant and ergonomic design
- Pluggable microphone
- Priority button
- Supporting 48 kHz audio sampling rate
- Excellent immunity to RF interference from mobile phones
- Separate adjustment of gain and EQ (5 band) of each microphone for the perfect sound

The stylish and ergonomically designed chairman unit has the necessary facilities to enable the user to chair a conference. It has excellent immunity to RF interference from mobile phones. Similar in appearance to HCS-48U6DMICS Delegate Unit, the HCS-48U6CMICS Chairman Unit includes a microphone priority button. When pressed, the priority button causes all currently active delegate microphones to be switched off temporarily or permanently, allowing the chairman to take control of the meeting.

Functions

- Compliant to ISO 22259
- Based on TAIDEN originated MCA-STREAM digital audio processing and transmitting technologies
- Proprietary MCA-STREAM technology used to transmit fully digital audio between the congress units as well as between congress units and main unit(s)
- Audio signals processed by high performance DSP: sound quality approaching CD quality
- Gain and EQ (5 band) of each microphone adjustable separately, fitting the individual orator's voice to achieve perfect speech pickup any time
- Supporting 48 kHz audio sampling rate
- Integrated high-pass filter (low-cut switch) to cut low frequency elements from the audio when needed
- Automatic system recovery and "PnP" (plug and play)
- Stem microphone can be unplugged during adjournment, easy to maintain
- Mini-microphone, with foam windshield
- Excellent immunity to RF interference from mobile phones and comparable devices
- Microphone On/Off button

- An ID can be assigned by default or manually to each conference unit bearing a unique serial number for convenient maintenance
- Facilities in independent operation from computer:
 - ◆ Set the number of delegates permitted to speak at the same time
 - ◆ Speak mode: Open/Override/Voice/Request/PTT
 - "Open" mode, microphone On/Off button with request-to-speak registration (AUTO)
 - "Override" mode, microphone On/Off button control with override of the active microphones (FIFO)
 - "Voice" mode, acoustic active sensitivity and automatic switch-off time adjustable continuously, built-in "flash-on" technology, immediate microphone activation on speaking
 - "Request" mode, delegate requests to speak by pressing microphone On/Off button, delegate only speaks when operator or chairman approved his application
 - "PTT" mode, press microphone On/Off button to talk
- Automatic video tracking implementation when cooperating with cameras & video switcher unit; preset positions on PC
- Activation at any time (if the amount of active microphones in the system is less than 8)
- Priority button to switch off or to mute the delegate units (except VIP units) according to preset
- Approves/denies delegates' speaking request
- System supports up to 100 chairman units, while all or part chairman units have the control facilities listed above (set by software or main unit)

Controls and Indicators

- Uni-directional electret condenser microphone with illuminated ring
- Microphone On/Off button with indicator
- Priority button

Interconnections

- Socket for pluggable microphone
- RJ11 socket, 2-pin cable and 3-pin cable for HCS-48U6SELM/80

Technical Specifications

Electrical

Recommended microphone type

Transducer.....	Electret-condenser
Polar pattern.....	Uni-directional
Operating voltage.....	5 VDC
Sensitivity.....	-46 dBV/Pa
Frequency response.....	50 Hz to 20 kHz
Input impedance.....	2 kOhm
Directivity 0°/180°.....	> 20 dB (1 kHz)
Equivalent noise.....	20 dBA (SPL)
Maximum sound pressure level.....	125 dB (THD<3%)

Mechanical

Mounting.....	Flush-mounting
Dimensions (h x w x d) (w/o stem microphone).....	36 x 100 x 40 mm
Weight (incl. stem microphone).....	0.2 kg
Color.....	Black (PANTONE 419 C)
Stem length.....	330 mm, 410 mm (standard version), 470 mm

Ordering Information

HCS-48U6CMICS.....Fully Digital Congress System
Chairman Unit (flush-mounting,
discussion, HCS-48U6SELM/80
needed, black)

HCS-48U6DMICS Delegate Unit



Features

- Flush-mounting, elegant and ergonomic design
- Pluggable microphone
- Supporting 48 kHz audio sampling rate
- Excellent immunity to RF interference from mobile phones
- Separate adjustment of gain and EQ (5 band) of each microphone for the perfect sound

This delegate unit meets the basic demands of most conferences. It provides facilities for speaking and registering a request-to-speak.

Functions

- Compliant to ISO 22259
- Based on TAIDEN originated MCA-STREAM digital audio processing and transmitting technologies
- Proprietary MCA-STREAM technology used to transmit fully digital audio between the congress units as well as between congress units and main unit(s)
- Audio signals processed by high performance DSP: sound quality approaching CD quality
- Gain and EQ (5 band) of each microphone adjustable separately, fitting the individual orator's voice to achieve perfect speech pickup any time.
- Supporting 48 kHz audio sampling rate
- Integrated high-pass filter (low-cut switch) to cut low frequency elements from the audio when needed
- Automatic system recovery and "PnP" (plug and play)
- Stem microphone can be unplugged during adjournment, easy to maintain
- Mini-microphone, with foam windshield
- Excellent immunity to RF interference from mobile phones and comparable devices
- Microphone On/Off button
- An ID can be assigned by default or manually to each conference unit bearing a unique serial number for convenient maintenance
- Facilities in independent operation from computer:
 - ◆ Set the number of delegates permitted to speak at the same time

- ◆ Speak mode: Open/Override/Voice/Request/PTT
 - "Open" mode, microphone On/Off button with request-to-speak registration (AUTO)
 - "Override" mode, microphone On/Off button control with override of the active microphones (FIFO)
 - "Voice" mode, acoustic active sensitivity and automatic switch-off time adjustable continuously, built-in "flash-on" technology, immediate microphone activation on speaking
 - "Request" mode, delegate requests to speak by pressing microphone On/Off button, delegate only speaks when operator or chairman approved his application
 - "PTT" mode, press microphone On/Off button to talk
- Automatic video tracking implementation when cooperating with cameras & video switcher unit; preset positions on PC
- Set any delegate unit to be VIP unit
 - ◆ Up to 32 units can be set as VIP in one system via application software
 - ◆ VIP unit can be activated as long as the total of active microphones is not beyond 8 (incl. chairman/delegate/VIP unit)

Controls and Indicators

- Uni-directional electret condenser microphone with illuminated ring
- Microphone On/Off button with indicator

Interconnections

- Socket for pluggable microphone
- RJ11 socket, 2-pin cable and 3-pin cable for HCS-48U6SELM/80

Technical Specifications

Electrical

Recommended microphone type

Transducer.....	Electret-condenser
Polar pattern.....	Uni-directional
Operating voltage.....	5 VDC
Sensitivity.....	-46 dBV/Pa
Frequency response.....	50 Hz to 20 kHz
Input impedance.....	2 kOhm
Directivity 0°/180°.....	> 20 dB (1 kHz)
Equivalent noise.....	20 dBA (SPL)
Maximum sound pressure level.....	125 dB (THD<3%)

Mechanical

Mounting.....	Flush-mounting
Dimensions (h x w x d) (w/o stem microphone).....	36 x 100 x 40 mm
Weight (incl. stem microphone).....	0.2 kg
Color.....	Black (PANTONE 419 C)
Stem length.....	330 mm, 410 mm (standard version), 470 mm

Ordering Information

HCS-48U6DMICS Fully Digital Congress System Delegate Unit (flush-mounting, discussion, HCS-48U6SELM/80 needed, black)

HCS-48U6SELM/80 Flush-mounting 64-Channel Selector



Features

- Ergonomically compact and elegant design
- 64 language channels for simultaneous interpretation, all channels with a 20 Hz to 20 kHz frequency response
- Faster processing speed and better audio quality with fully digital audio technology and built-in high-performance CPU
- Built-in “Silent” function
- Automatically adapts to available channels
- No audio output until the headphone is connected
- Flush mountable in table tops, on top or at the front, or in arm rests of seats
- Supporting "PnP" (plug and play)

The HCS-48U6SELM/80 is a compact and stylish single-user audio channel selector for listening by headphone. It provides a choice of up to 64 high-quality audio channels used for distribution of interpretation and floor channels.

Functions

- 64 language channels for simultaneous interpretation, all channels with a 20 Hz to 20 kHz frequency response
- Built-in channel selector (w/ up/down key) and OLED display
- The channel selector is active only when the headphone is inserted
- Built-in “Silent” function, to eliminate audible noise from the headphone. When not in use there is no audio output until one of the keys has been pressed
- Upon insertion of a headphone the default “floor” channel (channel 0) is selected with a comfortable headphone volume and the dimmed backlighting is activated

Controls and Indicators

- Two push-buttons (up/down) for channel selection
- Two push-buttons (up/down) for headphone volume control
- OLED display with screen saver

Interconnections

- Ø 3.5 mm socket for HCS-48U6SPK
- RJ11 socket for HCS-48U6VOT
- RJ11 socket, 2-pin socket and 3-pin socket for HCS-48U6MICS
- 2 × RJ45 socket for daisy chain connection (recommended use of cat5e cable with a drain wire & RJ45 plug with metal shield)

Technical Specifications

Electrical

Max. consumption.....	1.8 W
Frequency response.....	20 Hz to 20 kHz
Headphone load impedance.....	>16 Ohm
Output power.....	10 mW

Mechanical

Mounting.....	Flush-mounting
Dimensions (h x w x d).....	71 x 100 x 40 mm
Weight (incl. stem microphone).....	0.4 kg
Color.....	Black (PANTONE 419 C)

Ordering Information

HCS-48U6SELM/80.....	Flush-mounting 64-Channel Selector (HCS-48U6MICS, HCS-48U6VOT and HCS-48U6SPK can be connected, black)
----------------------	--

HCS-48U6DVOTTW Voting Unit with IC-Card Reader



Features

- Flush-mounting, elegant and ergonomic design
- Max system capacity: 4096 voting units
- 3 voting keys
- Built-in contactless IC-Card reader

Functions

- New digital design, compliant to many international standards
- Voting system is resistive to 8 kV static, conforms to IEC CISPR 24
- Max system capacity: 4096 voting units
- 3 voting keys
- In combination with corresponding software, multiform voting can be implemented:
 - ◆ For/Against
 - ◆ Parliamentary: YES/NO/ABSTAIN
 - ◆ Appraisal:
 - Satisfied (three keys voting: satisfied/basically satisfied/unsatisfied) (two keys voting: satisfied/unsatisfied)
 - Qualified (three/two keys voting)
 - Competent (three/two keys voting)
- Built-in contactless IC-Card reader
- Key-press sign-in
- Automatic detection

Interconnections

- RJ11 socket for HCS-48U6SELM/80 or HCS-48U6MICM/80

Technical Specifications

Mechanical

Mounting.....Flush-mounting
 Dimensions (h x w x d).....73 x 100 x 40 mm
 Weight.....0.1 kg
 Color.....Black (PANTONE 419 C)

Ordering Information

HCS-48U6DVOTTW.....Fully Digital Voting Unit (flush-mounting, 3 voting keys, built-in contactless IC-Card slot, HCS-48U6SELM/80 or HCS-48U6MICM/80 needed, black)

HCS-48U6DVOTTME/80 Voting Unit



Ordering Information

HCS-48U6DVOTTME/80.....Fully Digital Voting System Delegate Unit (flush-mounting, 3 voting keys, black)

Features

- Flush-mounting, stylish and ergonomic design
- Max. system capacity: 4096 voting units
- 3 voting keys
- Supporting "PnP" (plug and play)

Functions

- Compliant to ISO 22259
- "Closed Loop - Daisy Chain" connection topology for a high operational system reliability: breakdown or replacement of a voting unit and connection failure of a cable will not influence other voting units
- New digital design, compliant to many international standards
- Max system capacity: 4096 voting units
- Automatic system recovery and "PnP" (plug and play)
- 3 voting keys
- In combination with corresponding software modules, multiform voting can be implemented:
 - ◆ For/Against
 - ◆ Parliamentary: YES/NO/ABSTAIN
 - ◆ Appraisal:
 - Satisfied (three keys voting: satisfied/basically satisfied/unsatisfied) (two keys voting: satisfied/unsatisfied)
 - Qualified (three/two keys voting)
 - Competent (three/two keys voting)
- Key-press sign-in
- Automatic detection

Interconnections

- 2 × RJ45 socket for daisy chain connection (recommended use of cat5e cable with a drain wire & RJ45 plug with metal shield)

Technical Specifications

Electrical

Max. consumption.....1.8 W

Mechanical

Mounting.....Flush-mounting
 Dimensions (h x w x d).....73 x 100 x 40 mm
 Weight.....0.4 kg
 Color.....Black (PANTONE 419 C)

HCS-48U6SPK Flush Loudspeaker Panel



Technical Specifications

Connector..... Cable with Ø 3.5 mm jack

Mechanical

Mounting..... Flush-mounting

Dimensions (h x w x d)..... 71×80×80 mm

Weight..... 0.2 kg

Color..... Black (PANTONE 419 C)

Ordering Information

HCS-48U6SPK..... Flush-mounting Loudspeaker Panel
 (HCS-48U6SELM/80 or
 HCS-48U6MICM/80 needed, black)

HCS-48U7CM/80 Chairman Unit



Features

- **Elegant and ergonomic design**
- **Hi-Fi loudspeaker**
- **Priority button**
- **Pluggable microphone**
- **“Closed Loop - Daisy Chain” connection topology**
- **Supporting 48 kHz audio sampling rate**
- **Excellent immunity to RF interference from mobile phones**
- **Separate adjustment of gain and EQ (5 band) of each microphone for the perfect sound**
- **Supporting “PnP” (plug and play)**

The stylish and ergonomically designed chairman unit has the necessary facilities to enable the user to chair a conference. It has excellent immunity to RF interference from mobile phones. Similar in appearance to HCS-48U7DM/80 Delegate Unit, the HCS-48U7CM/80 Chairman Unit includes a microphone priority button. When pressed, the priority button causes all currently active delegate microphones to be switched off temporarily or permanently, allowing the chairman to take control of the meeting. The loudspeaker offers superior acoustics with minimal feedback for enhanced intelligibility.

Functions

- Compliant to ISO 22259
- “Closed Loop - Daisy Chain” connection topology for a high operational system reliability: breakdown or replacement of a congress unit and connection failure of a cable will not influence other congress units
- Based on TAIDEN originated MCA-STREAM digital audio processing and transmitting technologies
- Proprietary MCA-STREAM technology used to transmit fully digital audio between the congress units as well as between congress units and main unit(s)
- Audio signals processed by high performance DSP: sound quality approaching CD quality
- Gain and EQ (5 band) of each microphone adjustable separately, fitting the individual orator’s voice to achieve perfect speech pickup any time

- Supporting 48 kHz audio sampling rate
- Integrated high-pass filter (low-cut switch) to cut low frequency elements from the audio when needed
- Automatic system recovery and “PnP” (plug and play)
- Stem microphone can be unplugged during adjournment, easy to maintain
- Mini-microphone, with foam windshield
- Hi-Fi loudspeaker, minimal feedback, mutes automatically when microphone is active
- Excellent immunity to RF interference from mobile phones and comparable devices
- Microphone On/Off button
- An ID can be assigned by default or manually to each conference unit bearing a unique serial number for convenient maintenance
- Facilities in independent operation from computer:
 - ◆ Set the number of delegates permitted to speak at the same time
 - ◆ Speak mode: Open/Override/Voice/Request/PTT
 - “Open” mode, microphone On/Off button with request-to-speak registration (AUTO)
 - “Override” mode, microphone On/Off button control with override of the active microphones (FIFO)
 - “Voice” mode, acoustic active sensitivity and automatic switch-off time adjustable continuously, built-in “flash-on” technology, immediate microphone activation on speaking
 - “Request” mode, delegate requests to speak by pressing microphone On/Off button, delegate only speaks when operator or chairman approved his application
 - “PTT” mode, press microphone On/Off button to talk
- Automatic video tracking implementation when cooperating with cameras & video switcher unit; preset positions on PC
- Activation at any time (if the amount of active microphones in the system is less than 8)
- Priority button to switch off or to mute the delegate units (except VIP units) according to preset
- Approves/denies delegates’ speaking request
- System supports up to 100 chairman units, while all or part chairman units have the control facilities listed above (set by software or main unit)

Controls and Indicators

- Uni-directional electret condenser microphone with two-color illuminated ring
- Headphones volume up and down
- Microphone On/Off button with indicator
- Priority button

Interconnections

- Socket for pluggable microphone
- Ø 3.5 mm stereo headphone jack
- 2 × RJ45 socket for daisy chain connection (recommended use of cat5e cable with a drain wire & RJ45 plug with metal shield)

Technical Specifications

Electrical

Max. consumption.....2.0 W

Headphone connection

Frequency response.....20 Hz to 20 kHz

Earphone load impedance.....>16 Ohm

Earphone output.....10 mW

Recommended microphone type

Transducer.....Electret-condenser

Polar pattern.....Uni-directional

Operating voltage.....5 VDC

Sensitivity.....-46 dBV/Pa

Frequency response.....50 Hz to 20 kHz

Input impedance.....2 kOhm

Directivity 0°/180°.....> 20 dB (1 kHz)

Equivalent noise.....20 dBA (SPL)

Maximum sound pressure level.....125 dB (THD<3%)

Interface data

Connector.....Ø 3.5 mm stereo jack for headphone

Mechanical

Mounting.....Flush-mounting

Dimensions (h x w x d) (w/o stem microphone).....71 x 140 x 80 mm

Weight (incl. stem microphone).....0.6 kg

Color.....Black (PANTONE 419 C)

Stem length.....330 mm, 410 mm (standard version), 470 mm

Ordering Information

HCS-48U7CM/80.....Fully Digital Congress System Chairman
Unit (flush-mounting, discussion, built-in
loudspeaker and 3.5mm TRS
headphones jack, black)

HCS-48U7DM/80 Delegate Unit



Features

- **Elegant and ergonomic design**
- **Hi-Fi loudspeaker**
- **Pluggable microphone**
- **“Closed Loop - Daisy Chain” connection topology**
- **Supporting 48 kHz audio sampling rate**
- **Excellent immunity to RF interference from mobile phones**
- **Separate adjustment of gain and EQ (5 band) of each microphone for the perfect sound**
- **Supporting “PnP” (plug and play)**

This delegate unit meets the basic demands of most conferences. It provides facilities for speaking and registering a request-to-speak. Excellent immunity to RF interference from mobile phones. The loudspeaker offers superior acoustics with minimal feedback for enhanced intelligibility.

Functions

- Compliant to ISO 22259
- “Closed Loop - Daisy Chain” connection topology for a high operational system reliability: breakdown or replacement of a congress unit and connection failure of a cable will not influence other congress units
- Based on TAIDEN originated MCA-STREAM digital audio processing and transmitting technologies
- Proprietary MCA-STREAM technology used to transmit fully digital audio between the congress units as well as between congress units and main unit(s)
- Audio signals processed by high performance DSP: sound quality approaching CD quality
- Gain and EQ (5 band) of each microphone adjustable separately, fitting the individual orator’s voice to achieve perfect speech pickup any time
- Supporting 48 kHz audio sampling rate
- Integrated high-pass filter (low-cut switch) to cut low frequency elements from the audio when needed
- Automatic system recovery and “PnP” (plug and play)
- Stem microphone can be unplugged during adjournment, easy to maintain

- Mini-microphone, with foam windshield
- Hi-Fi loudspeaker, minimal feedback, mutes automatically when microphone is active
- Excellent immunity to RF interference from mobile phones and comparable devices
- Microphone On/Off button
- An ID can be assigned by default or manually to each conference unit bearing a unique serial number for convenient maintenance
- Facilities in independent operation from computer:
 - ◆ Set the number of delegates permitted to speak at the same time
 - ◆ Speak mode: Open/Override/Voice/Request/PTT
 - "Open" mode, microphone On/Off button with request-to-speak registration (AUTO)
 - "Override" mode, microphone On/Off button control with override of the active microphones (FIFO)
 - "Voice" mode, acoustic active sensitivity and automatic switch-off time adjustable continuously, built-in “flash-on” technology, immediate microphone activation on speaking
 - “Request” mode, delegate requests to speak by pressing microphone On/Off button, delegate only speaks when operator or chairman approved his application
 - "PTT" mode, press microphone On/Off button to talk
- Automatic video tracking implementation when cooperating with cameras & video switcher unit; preset positions on PC
- Set any delegate unit to be VIP unit
 - ◆ Up to 32 units can be set as VIP in one system via application software
 - ◆ VIP unit can be activated as long as the total of active microphones is not beyond 8 (incl. chairman/delegate/VIP unit)

Controls and Indicators

- Uni-directional electret condenser microphone with two-color illuminated ring
- Headphones volume up and down
- Microphone On/Off button with indicator

Interconnections

- Socket for pluggable microphone
- Ø 3.5 mm stereo headphone jack
- 2 × RJ45 socket for daisy chain connection (recommended use of cat5e cable with a drain wire & RJ45 plug with metal shield)

Technical Specifications

Electrical

Max. consumption.....2.0 W

Headphone connection

Frequency response.....20 Hz to 20 kHz

Earphone load impedance.....>16 Ohm

Earphone output.....10 mW

Recommended microphone type

Transducer.....Electret-condenser

Polar pattern.....Uni-directional

Operating voltage.....5 VDC

Sensitivity.....-46 dBV/Pa
 Frequency response.....50 Hz to 20 kHz
 Input impedance.....2 kOhm
 Directivity 0°/180°.....> 20 dB (1 kHz)
 Equivalent noise.....20 dBA (SPL)
 Maximum sound pressure level.....125 dB (THD<3%)

Interface data

Connector.....Ø 3.5 mm stereo jack for headphone

Mechanical

Mounting.....Flush-mounting
 Dimensions (h x w x d) (w/o stem microphone).....71 x 140 x 80 mm

Weight (incl. stem microphone).....0.6 kg
 Color.....Black (PANTONE 419 C)
 Stem length.....330 mm, 410 mm (standard version), 470 mm

Ordering Information

HCS-48U7DM/80.....Fully Digital Congress System Delegate Unit (flush-mounting, discussion, built-in loudspeaker and 3.5mm TRS headphones jack, black)

Function List

Model No.	Type	Speech	Main Unit	Cable
HCS-48U7CM7/80	Chairman	√	HCS-4800MA/20 HCS-4800MB/20	cat5e cable with a drain wire & RJ45 plug with metal shield
HCS-48U7DM/80	Delegate	√	HCS-4800MC	

Note: Connect to the main system through 8P2RJ45S transfer cable

HCS-48U8CVSW/80 Chairman Unit with Voting and Channel Selection



Features

- **Elegant and ergonomic design**
- **Hi-Fi loudspeaker**
- **Priority button**
- **Pluggable microphone**
- **5 voting keys**
- **“Closed Loop - Daisy Chain” connection topology**
- **Transmitting up to 64 CHs high quality digital audio signals on a dedicated cable**
- **Supporting 48 kHz audio sampling rate, all 64 channels perfectly reproducing audio frequencies between 20 Hz and 20 kHz**
- **Built-in channel selector consists of up/down channel select buttons**
- **Excellent immunity to RF interference from mobile phones**
- **Separate adjustment of gain and EQ (5 band) of each microphone for the perfect sound**
- **Supporting “PnP” (plug and play)**
- **Built-in multi-channel intercom facility**
- **Built-in contactless IC-Card reader**

The stylish and ergonomically designed chairman unit has all the necessary facilities to enable the user to chair a conference. It has excellent immunity to RF interference from mobile phones. Similar in appearance to HCS-48U8DVSW/80 Delegate Unit, the HCS-48U8CVSW/80 Chairman Unit includes a microphone priority button. When pressed, the priority button causes all currently active delegate microphones to be switched off temporarily or permanently, allowing the chairman to take control of the meeting. The chairman unit can also be used to start or stop voting, cancel a request-to-speak, turn off all active microphones and recall messages for display. A graphic LCD screen with permanent backlighting can display characters from complex European languages or icon-based scripts such as Chinese.

Channel selection is automatically limited to the number of language channels available.

The loudspeaker offers superior acoustics with minimal feedback for enhanced intelligibility.

Functions

- Compliant to ISO 22259
- “Closed Loop - Daisy Chain” connection topology for a high operational system reliability: breakdown or replacement of a congress unit and connection failure of a cable will not influence other congress units
- Based on TAIDEN originated MCA-STREAM digital audio processing and transmitting technologies
- Proprietary MCA-STREAM technology used to transmit fully digital audio between the congress units as well as between congress units and main unit(s)
- Audio signals processed by high performance DSP: sound quality approaching CD quality
- Gain and EQ (5 band) of each microphone adjustable separately, fitting the individual orator's voice to achieve perfect speech pickup any time
- Transmitting up to 64 CHs high quality digital audio signals on a dedicated cable (recommended use of cat5e cable with a drain wire)
- Supporting 48 kHz audio sampling rate, all 64 channels perfectly reproducing audio frequencies between 20 Hz and 20 kHz
- Integrated high-pass filter (low-cut switch) to cut low frequency elements from the audio when needed
- Automatic system recovery and “PnP” (plug and play)
- Stem microphone can be unplugged during adjournment, easy to maintain
- Mini-microphone, with foam windshield
- Hi-Fi loudspeaker, minimal feedback, mutes automatically when microphone is active
- Excellent immunity to RF interference from mobile phones and comparable devices
- Microphone On/Off button, 5 voting keys
- An ID can be assigned by default or manually to each conference unit bearing a unique serial number for convenient maintenance
- Facilities in independent operation from computer:
 - ◆ Set the number of delegates permitted to speak at the same time
 - ◆ Speak mode: Open/Override/Voice/Request/PTT
 - “Open” mode, microphone On/Off button with request-to-speak registration (AUTO)
 - “Override” mode, microphone On/Off button control with override of the active microphones (FIFO)
 - “Voice” mode, acoustic active sensitivity and automatic switch-off time adjustable continuously, built-in “flash-on” technology, immediate microphone activation on speaking
 - “Request” mode, delegate requests to speak by pressing microphone On/Off button, delegate only speaks when operator or chairman approved his application
 - “PTT” mode, press microphone On/Off button to talk
 - ◆ Voting function (Yes/No/Abstain)
 - ◆ Simultaneous interpretation
- Dedicated software for more forms of voting
- Built-in contactless IC-Card reader
- Key-press sign-in
- Automatic video tracking implementation when cooperating with cameras & video switcher unit; preset positions on PC
- Built-in multi-channel intercom facility

- Activation at any time (if the amount of active microphones in the system is less than 8)
- Priority button to switch off or to mute the delegate units (except VIP units) according to preset
- Approves/denies delegates' speaking request
- Initiates parliamentary voting (YES/NO/ABSTAIN) session without PC
- Controls voting start, hold, resume and stop
- Controls on-off switch for displaying voting results on delegate unit's LCD
- System supports up to 100 chairman units, while all or part chairman units have the control facilities listed above (set by software or main unit)

Controls and Indicators

- Graphic 256x32 LCD with back-lighting for displaying:
 - ◆ Active microphone amount, request amount, delegates signed-in and voting results, etc.
 - ◆ Messages (messages from system administrator to all or part of participants)
 - ◆ Multilingual (simplified/traditional Chinese and English, etc.) menu
 - ◆ Channel number and language name
- Built-in channel selector with up/down channel select buttons
- Uni-directional electret condenser microphone with two-color illuminated ring
- Headphones volume up and down
- Five voting keys with indicators
- Microphone On/Off button with indicator
- Priority button

Interconnections

- Socket for pluggable microphone
- Ø 3.5 mm stereo headphone jack
- Ø 3.5 mm socket for external microphone or headset microphone
- 2 × RJ45 socket for daisy chain connection (recommended use of cat5e cable with a drain wire & RJ45 plug with metal shield)

Interface data

Connector.....Ø 3.5 mm socket for external microphone
Ø 3.5 mm stereo jack for headphone

Mechanical

Mounting.....Flush-mounting
 Dimensions (h x w x d) (w/o stem microphone)....74 x 330 x 80 mm
 Weight (incl. stem microphone).....1.0 kg
 Color.....Black (PANTONE 419 C)
 Stem length.....330 mm, 410 mm (standard version), 470 mm

Ordering Information

HCS-48U8CVSW/80....Fully Digital Congress System Chairman Unit (flush-mounting, 5 voting keys, contactless IC-Card reader, 64 CHs, 256x32 LCD, black)

Technical Specifications

Electrical

Max. consumption.....2.3 W

Headphone connection

Frequency response.....20 Hz to 20 kHz
 Earphone load impedance.....>16 Ohm
 Earphone output.....10 mW

Recommended external microphone type (or headset microphone)

Transducer.....Electret-condenser
 Polar pattern.....Uni-directional
 Operating voltage.....5 VDC
 Sensitivity.....-46 dBV/Pa
 Frequency response.....50 Hz to 20 kHz
 Input impedance.....2 kOhm
 Directivity 0°/180°.....> 20 dB (1 kHz)
 Equivalent noise.....20 dBA (SPL)
 Maximum sound pressure level.....125 dB (THD<3%)

HCS-48U8DVSW/80 Delegate Unit with Voting and Channel Selection



Features

- **Elegant and ergonomic design**
- **Hi-Fi loudspeaker**
- **Pluggable microphone**
- **5 voting keys**
- **“Closed Loop - Daisy Chain” connection topology**
- **Transmitting up to 64 CHs high quality digital audio signals on a dedicated 6-pin cable**
- **Supporting 48 kHz audio sampling rate, all 64 channels perfectly reproducing audio frequencies between 20 Hz and 20 kHz**
- **Built-in channel selector consists of up/down channel select buttons**
- **Excellent immunity to RF interference from mobile phones**
- **Separate adjustment of gain and EQ (5 band) of each microphone for the perfect sound**
- **Supporting “PnP” (plug and play)**
- **Built-in multi-channel intercom facility**
- **Built-in contactless IC-Card reader**

The multi-functional delegate unit meets the demands of even the largest conferences. It provides facilities for speaking, registering a request-to-speak, registering a request-to-respond, listening, voting, selecting language channels, IC-Card reading and displaying conference and user-related information. Excellent immunity to RF interference from mobile phones. Channel selector, IC-Card reader and graphic display with backlighting. When the IC-Card approaches the card reader, the graphic LCD screen automatically displays user-related information in the language assigned to the delegate chip card. The graphic LCD is able to display characters from complex European languages or icon-based-scripts such as Chinese. Channel selection is automatically limited to the number of language channels available. The loudspeaker offers superior acoustics with minimal feedback for enhanced intelligibility.

Functions

- Compliant to ISO 22259
- “Closed Loop - Daisy Chain” connection topology for a high operational system reliability: breakdown or replacement of a congress unit and connection failure of a cable will not influence other congress units
- Based on TAIDEN originated MCA-STREAM digital audio processing and transmitting technologies
- Proprietary MCA-STREAM technology used to transmit fully digital audio between the congress units as well as between congress units and main unit(s)
- Audio signals processed by high performance DSP: sound quality approaching CD quality
- Gain and EQ (5 band) of each microphone adjustable separately, fitting the individual orator’s voice to achieve perfect speech pickup any time
- Transmitting up to 64 CHs high quality digital audio signals on a dedicated cable (recommended use of cat5e cable with a drain wire)
- Supporting 48 kHz audio sampling rate, all 64 channels perfectly reproducing audio frequencies between 20 Hz and 20 kHz
- Integrated high-pass filter (low-cut switch) to cut low frequency elements from the audio when needed
- Automatic system recovery and “PnP” (plug and play)
- Stem microphone can be unplugged during adjournment, easy to maintain
- Mini-microphone, with foam windshield
- Hi-Fi loudspeaker, minimal feedback, mutes automatically when microphone is active
- Excellent immunity to RF interference from mobile phones and comparable devices
- Microphone On/Off button, 5 voting keys
- An ID can be assigned by default or manually to each conference unit bearing a unique serial number for convenient maintenance
- Facilities in independent operation from computer:
 - ◆ Set the number of delegates permitted to speak at the same time
 - ◆ Speak mode: Open/Override/Voice/Request/PTT
 - “Open” mode, microphone On/Off button with request-to-speak registration (AUTO)
 - “Override” mode, microphone On/Off button control with override of the active microphones (FIFO)
 - “Voice” mode, acoustic active sensitivity and automatic switch-off time adjustable continuously, built-in “flash-on” technology, immediate microphone activation on speaking
 - “Request” mode, delegate requests to speak by pressing microphone On/Off button, delegate only speaks when operator or chairman approved his application
 - “PTT” mode, press microphone On/Off button to talk
 - ◆ Voting function (Yes/No/Abstain)
 - ◆ Simultaneous interpretation
- Dedicated software for more forms of voting
- Built-in contactless IC-Card reader
- Key-press sign-in
- Automatic video tracking implementation when cooperating with cameras & video switcher unit; preset positions on PC
- Built-in multi-channel intercom facility

- Set any delegate unit to be VIP unit
 - ◆ Up to 32 units can be set as VIP in one system via application software
 - ◆ VIP unit can be activated as long as the total of active microphones is not beyond 6 (incl. chairman/delegate/VIP unit)

Controls and Indicators

- Graphic 256x32 LCD with back-lighting for displaying:
 - ◆ Active microphone amount, request amount, delegates signed-in and voting results, etc.
 - ◆ Messages (messages from system administrator to all or part of participants)
 - ◆ Multilingual (simplified/traditional Chinese and English, etc.) menu
 - ◆ Channel number and language name
- Built-in channel selector with up/down channel select buttons
- Uni-directional electret condenser microphone with two-color illuminated ring
- Headphones volume up and down
- Five voting keys with indicators
- Microphone On/Off button with indicator

Interconnections

- Socket for pluggable microphone
- Ø 3.5 mm stereo headphone jack
- Ø 3.5 mm socket for external microphone or headset microphone
- 2 × RJ45 socket for daisy chain connection (recommended use of cat5e cable with a drain wire & RJ45 plug with metal shield)

Technical Specifications

Electrical

Max. consumption.....2.3 W

Headphone connection

Frequency response.....20 Hz to 20 kHz

Earphone load impedance.....>16 Ohm

Earphone output.....10 mW

Recommended external microphone type (or headset microphone)

Transducer.....Electret-condenser

Polar pattern.....Uni-directional

Operating voltage.....5 VDC

Sensitivity.....-46 dBV/Pa

Frequency response.....50 Hz to 20 kHz

Input impedance.....2 kOhm

Directivity 0°/180°.....> 20 dB (1 kHz)

Equivalent noise.....20 dBA (SPL)

Maximum sound pressure level.....125 dB (THD<3%)

Interface data

Connector.....Ø 3.5 mm socket for external microphone

.....Ø 3.5 mm stereo jack for headphone

Mechanical

Mounting.....Flush-mounting

Dimensions (h x w x d) (w/o stem microphone).....74 x 330 x 80 mm

Weight (incl. stem microphone).....1.0 kg

Color.....Black (PANTONE 419 C)

Stem length.....330 mm, 410 mm (standard version), 470 mm

Ordering Information

HCS-48U8DVSW/80.....Fully Digital Congress System Delegate Unit (flush-mounting, 5 voting keys, contactless IC-Card reader, 64 CHs, 256x32 LCD, black)

HCS-48U9CVSW/80 Chairman Unit with Voting and Channel Selection



Features

- **Elegant and ergonomic design**
- **Hi-Fi loudspeaker**
- **Priority button**
- **Pluggable microphone**
- **5 voting keys**
- **“Closed Loop - Daisy Chain” connection topology**
- **Transmitting up to 64 CHs high quality digital audio signals on a dedicated cable**
- **Supporting 48 kHz audio sampling rate, all 64 channels perfectly reproducing audio frequencies between 20 Hz and 20 kHz**
- **Built-in channel selector consists of up/down channel select buttons**
- **Excellent immunity to RF interference from mobile phones**
- **Separate adjustment of gain and EQ (5 band) of each microphone for the perfect sound**
- **Supporting “PnP” (plug and play)**
- **Built-in multi-channel intercom facility**
- **Built-in contactless IC-Card reader**

The stylish and ergonomically designed chairman unit has all the necessary facilities to enable the user to chair a conference. It has excellent immunity to RF interference from mobile phones. Similar in appearance to HCS-48U9DVSW/80 Delegate Unit, the HCS-48U9CVSW/80 Chairman Unit includes a microphone priority button. When pressed, the priority button causes all currently active delegate microphones to be switched off temporarily or permanently, allowing the chairman to take control of the meeting. The chairman unit can also be used to start or stop voting, cancel a request-to-speak, turn off all active microphones and recall messages for display. A graphic LCD screen with permanent backlighting can display characters from complex European languages or icon-based scripts such as Chinese.

Channel selection is automatically limited to the number of language channels available.

The loudspeaker offers superior acoustics with minimal feedback for enhanced intelligibility.

Functions

- Compliant to ISO 22259
- “Closed Loop - Daisy Chain” connection topology for a high operational system reliability: breakdown or replacement of a congress unit and connection failure of a cable will not influence other congress units
- Based on TAIDEN originated MCA-STREAM digital audio processing and transmitting technologies
- Proprietary MCA-STREAM technology used to transmit fully digital audio between the congress units as well as between congress units and main unit(s)
- Audio signals processed by high performance DSP: sound quality approaching CD quality
- Gain and EQ (5 band) of each microphone adjustable separately, fitting the individual orator's voice to achieve perfect speech pickup any time
- Transmitting up to 64 CHs high quality digital audio signals on a dedicated cable (recommended use of cat5e cable with a drain wire)
- Supporting 48 kHz audio sampling rate, all 64 channels perfectly reproducing audio frequencies between 20 Hz and 20 kHz
- Integrated high-pass filter (low-cut switch) to cut low frequency elements from the audio when needed
- Automatic system recovery and “PnP” (plug and play)
- Stem microphone can be unplugged during adjournment, easy to maintain
- Mini-microphone, with foam windshield
- Hi-Fi loudspeaker, minimal feedback, mutes automatically when microphone is active
- Excellent immunity to RF interference from mobile phones and comparable devices
- Microphone On/Off button, 5 voting keys
- An ID can be assigned by default or manually to each conference unit bearing a unique serial number for convenient maintenance
- Facilities in independent operation from computer:
 - ◆ Set the number of delegates permitted to speak at the same time
 - ◆ Speak mode: Open/Override/Voice/Request/PTT
 - “Open” mode, microphone On/Off button with request-to-speak registration (AUTO)
 - “Override” mode, microphone On/Off button control with override of the active microphones (FIFO)
 - “Voice” mode, acoustic active sensitivity and automatic switch-off time adjustable continuously, built-in “flash-on” technology, immediate microphone activation on speaking
 - “Request” mode, delegate requests to speak by pressing microphone On/Off button, delegate only speaks when operator or chairman approved his application
 - “PTT” mode, press microphone On/Off button to talk
 - ◆ Voting function (Yes/No/Abstain)
 - ◆ Simultaneous interpretation
- Dedicated software for more forms of voting
- Built-in contactless IC-Card reader
- Key-press sign-in
- Automatic video tracking implementation when cooperating with cameras & video switcher unit; preset positions on PC
- Built-in multi-channel intercom facility

- Activation at any time (if the amount of active microphones in the system is less than 8)
- Priority button to switch off or to mute the delegate units (except VIP units) according to preset
- Approves/denies delegates' speaking request
- Initiates parliamentary voting (YES/NO/ABSTAIN) session without PC
- Controls voting start, hold, resume and stop
- Controls on-off switch for displaying voting results on delegate unit's LCD
- System supports up to 100 chairman units, while all or part chairman units have the control facilities listed above (set by software or main unit)

Controls and Indicators

- Graphic 256x32 LCD with back-lighting for displaying:
 - ◆ Active microphone amount, request amount, delegates signed-in and voting results, etc.
 - ◆ Messages (messages from system administrator to all or part of participants)
 - ◆ Multilingual (simplified/traditional Chinese and English, etc.) menu
 - ◆ Channel number and language name
- Built-in channel selector with up/down channel select buttons
- Uni-directional electret condenser microphone with two-color illuminated ring
- Headphones volume up and down
- Five voting keys with indicators
- Microphone On/Off button with indicator
- Priority button

Interconnections

- Socket for pluggable microphone
- Ø 3.5 mm stereo headphone jack
- Ø 3.5 mm socket for external microphone or headset microphone
- 2 × RJ45 socket for daisy chain connection (recommended use of cat5e cable with a drain wire & RJ45 plug with metal shield)

Technical Specifications

Electrical

Max. consumption.....2.3 W

Headphone connection

Frequency response.....20 Hz to 20 kHz

Earphone load impedance.....>16 Ohm

Earphone output.....10 mW

Recommended external microphone type (or headset microphone)

Transducer.....Electret-condenser

Polar pattern.....Uni-directional

Operating voltage.....5 VDC

Sensitivity.....-46 dBV/Pa

Frequency response.....50 Hz to 20 kHz

Input impedance.....2 kOhm

Directivity 0°/180°.....> 20 dB (1 kHz)

Equivalent noise.....20 dBA (SPL)

Maximum sound pressure level.....125 dB (THD<3%)

Interface data

Connector.....Ø 3.5 mm socket for external microphone
Ø 3.5 mm stereo jack for headphone

Mechanical

Mounting.....Flush-mounting

Dimensions (h x w x d) (w/o stem microphone).....74 x 330 x 80 mm

Weight (incl. stem microphone).....1.0 kg

Color.....Black (PANTONE 419 C)

Stem length.....330 mm, 410 mm (standard version), 470 mm

Ordering Information

HCS-48U9CVSW/80.....Fully Digital Congress System Chairman Unit (flush-mounting, 5 voting keys, contactless IC-Card reader, 64 CHs, 256x32 LCD, black)

HCS-48U9DVSW/80 Delegate Unit with Voting and Channel Selection



Features

- **Elegant and ergonomic design**
- **Hi-Fi loudspeaker**
- **Pluggable microphone**
- **5 voting keys**
- **“Closed Loop - Daisy Chain” connection topology**
- **Transmitting up to 64 CHs high quality digital audio signals on a dedicated 6-pin cable**
- **Supporting 48 kHz audio sampling rate, all 64 channels perfectly reproducing audio frequencies between 20 Hz and 20 kHz**
- **Built-in channel selector consists of up/down channel select buttons**
- **Excellent immunity to RF interference from mobile phones**
- **Separate adjustment of gain and EQ (5 band) of each microphone for the perfect sound**
- **Supporting “PnP” (plug and play)**
- **Built-in multi-channel intercom facility**
- **Built-in contactless IC-Card reader**

The multi-functional delegate unit meets the demands of even the largest conferences. It provides facilities for speaking, registering a request-to-speak, registering a request-to-respond, listening, voting, selecting language channels, IC-Card reading and displaying conference and user-related information. Excellent immunity to RF interference from mobile phones. Channel selector, IC-Card reader and graphic display with backlighting. When the IC-Card approaches the card reader, the graphic LCD screen automatically displays user-related information in the language assigned to the delegate chip card. The graphic LCD is able to display characters from complex European languages or icon-based-scripts such as Chinese. Channel selection is automatically limited to the number of language channels available. The loudspeaker offers superior acoustics with minimal feedback for enhanced intelligibility.

Functions

- Compliant to ISO 22259
- “Closed Loop - Daisy Chain” connection topology for a high operational system reliability: breakdown or replacement of a congress unit and connection failure of a cable will not influence other congress units
- Based on TAIDEN originated MCA-STREAM digital audio processing and transmitting technologies
- Proprietary MCA-STREAM technology used to transmit fully digital audio between the congress units as well as between congress units and main unit(s)
- Audio signals processed by high performance DSP: sound quality approaching CD quality
- Gain and EQ (5 band) of each microphone adjustable separately, fitting the individual orator’s voice to achieve perfect speech pickup any time
- Transmitting up to 64 CHs high quality digital audio signals on a dedicated cable (recommended use of cat5e cable with a drain wire)
- Supporting 48 kHz audio sampling rate, all 64 channels perfectly reproducing audio frequencies between 20 Hz and 20 kHz
- Integrated high-pass filter (low-cut switch) to cut low frequency elements from the audio when needed
- Automatic system recovery and “PnP” (plug and play)
- Stem microphone can be unplugged during adjournment, easy to maintain
- Mini-microphone, with foam windshield
- Hi-Fi loudspeaker, minimal feedback, mutes automatically when microphone is active
- Excellent immunity to RF interference from mobile phones and comparable devices
- Microphone On/Off button, 5 voting keys
- An ID can be assigned by default or manually to each conference unit bearing a unique serial number for convenient maintenance
- Facilities in independent operation from computer:
 - ◆ Set the number of delegates permitted to speak at the same time
 - ◆ Speak mode: Open/Override/Voice/Request/PTT
 - “Open” mode, microphone On/Off button with request-to-speak registration (AUTO)
 - “Override” mode, microphone On/Off button control with override of the active microphones (FIFO)
 - “Voice” mode, acoustic active sensitivity and automatic switch-off time adjustable continuously, built-in “flash-on” technology, immediate microphone activation on speaking
 - “Request” mode, delegate requests to speak by pressing microphone On/Off button, delegate only speaks when operator or chairman approved his application
 - “PTT” mode, press microphone On/Off button to talk
 - ◆ Voting function (Yes/No/Abstain)
 - ◆ Simultaneous interpretation
- Dedicated software for more forms of voting
- Built-in contactless IC-Card reader
- Key-press sign-in
- Automatic video tracking implementation when cooperating with cameras & video switcher unit; preset positions on PC
- Built-in multi-channel intercom facility

- Set any delegate unit to be VIP unit
 - ◆ Up to 32 units can be set as VIP in one system via application software
 - ◆ VIP unit can be activated as long as the total of active microphones is not beyond 6 (incl. chairman/delegate/VIP unit)

Controls and Indicators

- Graphic 256x32 LCD with back-lighting for displaying:
 - ◆ Active microphone amount, request amount, delegates signed-in and voting results, etc.
 - ◆ Messages (messages from system administrator to all or part of participants)
 - ◆ Multilingual (simplified/traditional Chinese and English, etc.) menu
 - ◆ Channel number and language name
- Built-in channel selector with up/down channel select buttons
- Uni-directional electret condenser microphone with two-color illuminated ring
- Headphones volume up and down
- Five voting keys with indicators
- Microphone On/Off button with indicator

Interconnections

- Socket for pluggable microphone
- Ø 3.5 mm stereo headphone jack
- Ø 3.5 mm socket for external microphone or headset microphone
- 2 × RJ45 socket for daisy chain connection (recommended use of cat5e cable with a drain wire & RJ45 plug with metal shield)

Technical Specifications

Electrical

Max. consumption.....2.3 W

Headphone connection

Frequency response.....20 Hz to 20 kHz

Earphone load impedance.....>16 Ohm

Earphone output.....10 mW

Recommended external microphone type (or headset microphone)

Transducer.....Electret-condenser

Polar pattern.....Uni-directional

Operating voltage.....5 VDC

Sensitivity.....-46 dBV/Pa

Frequency response.....50 Hz to 20 kHz

Input impedance.....2 kOhm

Directivity 0°/180°.....> 20 dB (1 kHz)

Equivalent noise.....20 dBA (SPL)

Maximum sound pressure level.....125 dB (THD<3%)

Interface data

Connector.....Ø 3.5 mm socket for external microphone

.....Ø 3.5 mm stereo jack for headphone

Mechanical

Mounting.....Flush-mounting

Dimensions (h x w x d) (w/o stem microphone).....74 x 330 x 80 mm

Weight (incl. stem microphone).....1.0 kg

Color.....Black (PANTONE 419 C)

Stem length.....330 mm, 410 mm (standard version), 470 mm

Ordering Information

HCS-48U9DVSW/80.....Fully Digital Congress System Delegate Unit (flush-mounting, 5 voting keys, contactless IC-Card reader, 64 CHs, 256x32 LCD, black)

HCS-48U10CVSE/80 Chairman Unit with Voting and Channel Selection



Features

- **Elegant and ergonomic design**
- **Hi-Fi loudspeaker**
- **Priority button**
- **Pluggable microphone**
- **3 voting keys**
- **OLED screen with high brightness and contrast, wide viewing angle and low power consumption**
- **“Closed Loop - Daisy Chain” connection topology**
- **Transmitting up to 64 CHs high quality digital audio signals on a dedicated 8-pin cable**
- **Supporting 48 kHz audio sampling rate, all 64 channels perfectly reproducing audio frequencies between 20 Hz and 20 kHz**
- **Built-in channel selector consists of up/down channel select buttons**
- **Excellent immunity to RF interference from mobile phones**
- **Separate adjustment of gain and EQ (5 band) of each microphone for the perfect sound**
- **Supporting “PnP” (plug and play)**
- **Built-in multi-channel intercom facility**
- **Built-in contactless IC-Card reader**

The stylish and ergonomically designed chairman unit has all the necessary facilities to enable the user to chair a conference. It has excellent immunity to RF interference from mobile phones. Similar in appearance to HCS-48U10DVSE/80 Delegate Unit, the HCS-48U10CVSE/80 Chairman Unit includes a microphone priority button. When pressed, the priority button causes all currently active delegate microphones to be switched off temporarily or permanently, allowing the chairman to take control of the meeting. A graphic OLED can display operation menu, channel number and language name. Channel selection is automatically limited to the number of language channels available.

The loudspeaker offers superior acoustics with minimal feedback for enhanced intelligibility.

Functions

- Compliant to ISO 22259
- “Closed Loop - Daisy Chain” connection topology for a high operational system reliability: breakdown or replacement of a congress unit and connection failure of a cable will not influence other congress units
- Based on TAIDEN originated MCA-STREAM digital audio processing and transmitting technologies
- Proprietary MCA-STREAM technology used to transmit fully digital audio between the congress units as well as between congress units and main unit(s)
- Audio signals processed by high performance DSP: sound quality approaching CD quality
- Gain and EQ (5 band) of each microphone adjustable separately, fitting the individual orator's voice to achieve perfect speech pickup any time
- Transmitting up to 64 CHs high quality digital audio signals on a dedicated cable (recommended use of cat5e cable with a drain wire)
- Supporting 48 kHz audio sampling rate, all 64 channels perfectly reproducing audio frequencies between 20 Hz and 20 kHz
- Integrated high-pass filter (low-cut switch) to cut low frequency elements from the audio when needed
- Automatic system recovery and “PnP” (plug and play)
- Stem microphone can be unplugged during adjournment, easy to maintain
- Mini-microphone, built-in foam windshield
- Hi-Fi loudspeaker, minimal feedback, mutes automatically when microphone is active
- Excellent immunity to RF interference from mobile phones and comparable devices
- Microphone On/Off button, 3 voting keys
- An ID can be assigned by default or manually to each conference unit bearing a unique serial number for convenient maintenance
- Facilities in independent operation from computer:
 - ◆ Set the number of delegates permitted to speak at the same time
 - ◆ Speak mode: Open/Override/Voice/Request/PTT
 - “Open” mode, microphone On/Off button with request-to-speak registration (AUTO)
 - “Override” mode, microphone On/Off button control with override of the active microphones (FIFO)
 - “Voice” mode, acoustic active sensitivity and automatic switch-off time adjustable continuously, built-in “flash-on” technology, immediate microphone activation on speaking
 - “Request” mode, delegate requests to speak by pressing microphone On/Off button, delegate only speaks when operator or chairman approved his application
 - “PTT” mode, press microphone On/Off button to talk
 - ◆ Simultaneous interpretation
- Voting function (Yes/No/Abstain) in combination with the corresponding software
- Key-press sign-in, contactless IC-Card sign-in
- Built-in contactless IC-Card slot to place the IC card, while automatically logout once the card is taken out from the slot
- Automatic video tracking implementation when cooperating with cameras & video switcher unit; preset positions on PC

- Built-in multi-channel intercom facility
- Activation at any time (if the amount of active microphones in the system is less than 8)
- Priority button to switch off or to mute the delegate units (except VIP units) according to preset
- Approves/denies delegates' speaking request
- System supports up to 100 chairman units, while all or part chairman units have the control facilities listed above (set by software or main unit)

Controls and Indicators

- Graphic 128x36 OLED with screen saver for displaying:
 - ◆ English menu
 - ◆ Channel number and language name
- Built-in channel selector with up/down channel select buttons
- Uni-directional electret condenser microphone with two-color illuminated ring
- Headphones volume up and down
- Three voting keys with indicators
- Microphone On/Off button with indicator
- Priority button

Interconnections

- Socket for pluggable microphone
- Ø 3.5 mm stereo headphone jack
- 2 × RJ45 socket for daisy chain connection (recommended use of cat5e cable with a drain wire & RJ45 plug with metal shield)

Technical Specifications

Electrical

Max. consumption.....2.0 W

Headphone connection

Frequency response.....20 Hz to 20 kHz

Earphone load impedance.....>16 Ohm

Earphone output.....10 mW

Recommended microphone type

Transducer.....Electret-condenser

Polar pattern.....Uni-directional

Operating voltage.....5 VDC

Sensitivity.....-46 dBV/Pa

Frequency response.....50 Hz to 20 kHz

Input impedance.....2 kOhm

Directivity 0°/180°.....> 20 dB (1 kHz)

Equivalent noise.....20 dBA (SPL)

Maximum sound pressure level.....125 dB (THD<3%)

Interface data

Connector.....Ø 3.5 mm stereo jack for headphone

Mechanical

Mounting.....Flush-mounting

Dimensions (h x w x d) (w/o stem microphone).....72 x 245 x 80 mm

Weight (incl. stem microphone).....0.8 kg

Color.....Black (PANTONE 419 C)

Stem length.....330 mm, 410 mm (standard version), 470 mm

Ordering Information

HCS-48U10CVSE/80.....Fully Digital Congress System Chairman Unit (flush-mounting, discussion, 3 voting keys, built-in contactless IC-Card slot, 64 CHs, OLED, black)

HCS-48U10DVSE/80 Delegate Unit with Voting and Channel Selection



Features

- **Elegant and ergonomic design**
- **Hi-Fi loudspeaker**
- **Pluggable microphone**
- **3 voting keys**
- **OLED screen with high brightness and contrast, wide viewing angle and low power consumption**
- **“Closed Loop - Daisy Chain” connection topology**
- **Transmitting up to 64 CHs high quality digital audio signals on a dedicated 8-pin cable**
- **Supporting 48 kHz audio sampling rate, all 64 channels perfectly reproducing audio frequencies between 20 Hz and 20 kHz**
- **Built-in channel selector consists of up/down channel select buttons**
- **Excellent immunity to RF interference from mobile phones**
- **Separate adjustment of gain and EQ (5 band) of each microphone for the perfect sound**
- **Supporting “PnP” (plug and play)**
- **Built-in multi-channel intercom facility**
- **Built-in contactless IC-Card reader**

The multi-functional delegate unit meets the demands of even the largest conferences. It provides facilities for speaking, registering a request-to-speak, listening, voting, selecting language channels and IC-Card sign-in. Excellent immunity to RF interference from mobile phones. A graphic OLED screen can display operation menu, channel number and language name. Channel selection is automatically limited to the number of language channels available. The loudspeaker offers superior acoustics with minimal feedback for enhanced intelligibility.

Functions

- Compliant to ISO 22259
- “Closed Loop - Daisy Chain” connection topology for a high operational system reliability: breakdown or replacement of a congress unit and connection failure of a cable will not influence other congress units
- Based on TAIDEN originated MCA-STREAM digital audio processing and transmitting technologies
- Proprietary MCA-STREAM technology used to transmit fully digital audio between the congress units as well as between congress units and main unit(s)
- Audio signals processed by high performance DSP: sound quality approaching CD quality
- Gain and EQ (5 band) of each microphone adjustable separately, fitting the individual orator’s voice to achieve perfect speech pickup any time
- Transmitting up to 64 CHs high quality digital audio signals on a dedicated cable (recommended use of cat5e cable with a drain wire)
- Supporting 48 kHz audio sampling rate, all 64 channels perfectly reproducing audio frequencies between 20 Hz and 20 kHz
- Integrated high-pass filter (low-cut switch) to cut low frequency elements from the audio when needed
- Automatic system recovery and “PnP” (plug and play)
- Stem microphone can be unplugged during adjournment, easy to maintain
- Mini-microphone, built-in foam windshield
- Hi-Fi loudspeaker, minimal feedback, mutes automatically when microphone is active
- Excellent immunity to RF interference from mobile phones and comparable devices
- Microphone On/Off button, 3 voting keys
- An ID can be assigned by default or manually to each conference unit bearing a unique serial number for convenient maintenance
- Facilities in independent operation from computer:
 - ◆ Set the number of delegates permitted to speak at the same time
 - ◆ Speak mode: Open/Override/Voice/Request/PTT
 - "Open" mode, microphone On/Off button with request-to-speak registration (AUTO)
 - "Override" mode, microphone On/Off button control with override of the active microphones (FIFO)
 - "Voice" mode, acoustic active sensitivity and automatic switch-off time adjustable continuously, built-in “flash-on” technology, immediate microphone activation on speaking
 - "Request" mode, delegate requests to speak by pressing microphone On/Off button, delegate only speaks when operator or chairman approved his application
 - "PTT" mode, press microphone On/Off button to talk
 - ◆ Simultaneous interpretation
- Voting function (Yes/No/Abstain) in combination with the corresponding software
- Key-press sign-in, contactless IC-Card sign-in
- Built-in contactless IC-Card slot to place the IC card, while automatically logout once the card is taken out from the slot
- Automatic video tracking implementation when cooperating with cameras & video switcher unit; preset positions on PC

- Built-in multi-channel intercom facility
- Set any delegate unit to be VIP unit
 - ◆ Up to 32 units can be set as VIP in one system via application software
 - ◆ VIP unit can be activated as long as the total of active microphones is not beyond 8 (incl. chairman/delegate/VIP unit)

Controls and Indicators

- Graphic 128x36 OLED with screen saver for displaying:
 - ◆ English menu
 - ◆ Channel number and language name
- Built-in channel selector with up/down channel select buttons
- Uni-directional electret condenser microphone with two-color illuminated ring
- Headphones volume up and down
- Three voting keys with indicators
- Microphone On/Off button with indicator

Interconnections

- Socket for pluggable microphone
- Ø 3.5 mm stereo headphone jack
- 2 × RJ45 socket for daisy chain connection (recommended use of cat5e cable with a drain wire & RJ45 plug with metal shield)

Technical Specifications

Electrical

Max. consumption.....2.0 W

Headphone connection

Frequency response.....20 Hz to 20 kHz

Earphone load impedance.....>16 Ohm

Earphone output.....10 mW

Recommended microphone type

Transducer.....Electret-condenser

Polar pattern.....Uni-directional

Operating voltage.....5 VDC

Sensitivity.....-46 dBV/Pa

Frequency response.....50 Hz to 20 kHz

Input impedance.....2 kOhm

Directivity 0°/180°.....> 20 dB (1 kHz)

Equivalent noise.....20 dBA (SPL)

Maximum sound pressure level.....125 dB (THD<3%)

Interface data

Connector.....Ø 3.5 mm stereo jack for headphone

Mechanical

Mounting.....Flush-mounting

Dimensions (h x w x d) (w/o stem microphone).....72 x 245 x 80 mm

Weight (incl. stem microphone).....0.8 kg

Color.....Black (PANTONE 419 C)

Stem length.....330 mm, 410 mm (standard version), 470 mm

Ordering Information

HCS-48U10DVSE/80..... Fully Digital Congress System Delegate Unit (flush-mounting, discussion, 3 voting keys, built-in contactless IC-Card slot, 64 CHs, OLED, black)

HCS-48U10DVE/80 Delegate Unit with Voting



Features

- **Elegant and ergonomic design**
- **Hi-Fi loudspeaker**
- **Pluggable microphone**
- **3 voting keys**
- **“Closed Loop - Daisy Chain” connection topology**
- **Excellent immunity to RF interference from mobile phones**
- **Separate adjustment of gain and EQ (5 band) of each microphone for the perfect sound**
- **Supporting “PnP” (plug and play)**
- **Built-in contactless IC-Card reader**

The multi-functional delegate unit meets the demands of even the largest conferences. It provides facilities for speaking, registering a request-to-speak, listening, voting and IC-Card sign-in. Excellent immunity to RF interference from mobile phones.

The loudspeaker offers superior acoustics with minimal feedback for enhanced intelligibility.

Functions

- Compliant to ISO 22259
- “Closed Loop - Daisy Chain” connection topology for a high operational system reliability: breakdown or replacement of a congress unit and connection failure of a cable will not influence other congress units
- Based on TAIDEN originated MCA-STREAM digital audio processing and transmitting technologies
- Proprietary MCA-STREAM technology used to transmit fully digital audio between the congress units as well as between congress units and main unit(s)
- Audio signals processed by high performance DSP: sound quality approaching CD quality
- Gain and EQ (5 band) of each microphone adjustable separately, fitting the individual orator’s voice to achieve perfect speech pickup any time
- Integrated high-pass filter (low-cut switch) to cut low frequency elements from the audio when needed
- Automatic system recovery and “PnP” (plug and play)
- Stem microphone can be unplugged during adjournment, easy to maintain

- Mini-microphone, built-in foam windshield
- Hi-Fi loudspeaker, minimal feedback, mutes automatically when microphone is active
- Excellent immunity to RF interference from mobile phones and comparable devices
- Microphone On/Off button, 3 voting keys
- An ID can be assigned by default or manually to each conference unit bearing a unique serial number for convenient maintenance
- Facilities in independent operation from computer:
 - ◆ Set the number of delegates permitted to speak at the same time
 - ◆ Speak mode: Open/Override/Voice/Request/PTT
 - “Open” mode, microphone On/Off button with request-to-speak registration (AUTO)
 - “Override” mode, microphone On/Off button control with override of the active microphones (FIFO)
 - “Voice” mode, acoustic active sensitivity and automatic switch-off time adjustable continuously, built-in “flash-on” technology, immediate microphone activation on speaking
 - “Request” mode, delegate requests to speak by pressing microphone On/Off button, delegate only speaks when operator or chairman approved his application
 - “PTT” mode, press microphone On/Off button to talk
- Voting function (Yes/No/Abstain) in combination with the corresponding software
- Key-press sign-in, contactless IC-Card sign-in
- Built-in contactless IC-Card slot to place the IC card, while automatically logout once the card is taken out from the slot
- Automatic video tracking implementation when cooperating with cameras & video switcher unit; preset positions on PC
- Set any delegate unit to be VIP unit
 - ◆ Up to 32 units can be set as VIP in one system via application software
 - ◆ VIP unit can be activated as long as the total of active microphones is not beyond 8 (incl. chairman/delegate/VIP unit)

Controls and Indicators

- Uni-directional electret condenser microphone with two-color illuminated ring
- Three voting keys with indicators
- Microphone On/Off button with indicator

Interconnections

- Socket for pluggable microphone
- 2 × RJ45 socket for daisy chain connection (recommended use of cat5e cable with a drain wire & RJ45 plug with metal shield)

Technical Specifications

Electrical

Max. consumption.....2.0 W

Recommended microphone type

Transducer.....Electret-condenser

Polar pattern.....Uni-directional

Operating voltage.....5 VDC

Sensitivity.....-46 dBV/Pa

Frequency response.....50 Hz to 20 kHz

Input impedance.....2 kOhm
 Directivity 0°/180°.....> 20 dB (1 kHz)
 Equivalent noise.....20 dBA (SPL)
 Maximum sound pressure level.....125 dB (THD<3%)

Mechanical

Mounting.....Flush-mounting
 Dimensions (h x w x d) (w/o stem microphone).....72 x 245 x 80 mm
 Weight (incl. stem microphone).....0.8 kg
 Color.....Black (PANTONE 419 C)
 Stem length.....330 mm, 410 mm (standard version), 470 mm

Ordering Information

HCS-48U10DVE/80.....Fully Digital Congress System Delegate
 Unit (flush-mounting, discussion, 3
 voting keys, built-in contactless IC-Card
 slot, black)

HCS-48U10DS/80 Delegate Unit with Channel Selection



Features

- **Elegant and ergonomic design**
- **Hi-Fi loudspeaker**
- **Pluggable microphone**
- **OLED screen with high brightness and contrast, wide viewing angle and low power consumption**
- **“Closed Loop - Daisy Chain” connection topology**
- **Transmitting up to 64 CHs high quality digital audio signals on a dedicated 8-pin cable**
- **Supporting 48 kHz audio sampling rate, all 64 channels perfectly reproducing audio frequencies between 20 Hz and 20 kHz**
- **Built-in channel selector consists of up/down channel select buttons**
- **Excellent immunity to RF interference from mobile phones**
- **Separate adjustment of gain and EQ (5 band) of each microphone for the perfect sound**
- **Supporting “PnP” (plug and play)**

The multi-functional delegate unit meets the demands of even the largest conferences. It provides facilities for speaking, registering a request-to-speak, listening, selecting language channels. Excellent immunity to RF interference from mobile phones. A graphic OLED screen can display operation menu, channel number and language name. Channel selection is automatically limited to the number of language channels available.

The loudspeaker offers superior acoustics with minimal feedback for enhanced intelligibility.

Functions

- Compliant to ISO 22259
- “Closed Loop - Daisy Chain” connection topology for a high operational system reliability: breakdown or replacement of a congress unit and connection failure of a cable will not influence other congress units
- Based on TAIDEN originated MCA-STREAM digital audio processing and transmitting technologies
- Proprietary MCA-STREAM technology used to transmit fully digital audio between the congress units as well as between congress units and main unit(s)
- Audio signals processed by high performance DSP: sound quality approaching CD quality
- Gain and EQ (5 band) of each microphone adjustable separately, fitting the individual orator's voice to achieve perfect speech pickup any time
- Transmitting up to 64 CHs high quality digital audio signals on a dedicated cable (recommended use of cat5e cable with a drain wire)
- Supporting 48 kHz audio sampling rate, all 64 channels perfectly reproducing audio frequencies between 20 Hz and 20 kHz
- Integrated high-pass filter (low-cut switch) to cut low frequency elements from the audio when needed
- Automatic system recovery and “PnP” (plug and play)
- Stem microphone can be unplugged during adjournment, easy to maintain
- Mini-microphone, built-in foam windshield
- Hi-Fi loudspeaker, minimal feedback, mutes automatically when microphone is active
- Excellent immunity to RF interference from mobile phones and comparable devices
- Microphone On/Off button
- An ID can be assigned by default or manually to each conference unit bearing a unique serial number for convenient maintenance
- Facilities in independent operation from computer:
 - ◆ Set the number of delegates permitted to speak at the same time
 - ◆ Speak mode: Open/Override/Voice/Request/PTT
 - “Open” mode, microphone On/Off button with request-to-speak registration (AUTO)
 - “Override” mode, microphone On/Off button control with override of the active microphones (FIFO)
 - “Voice” mode, acoustic active sensitivity and automatic switch-off time adjustable continuously, built-in “flash-on” technology, immediate microphone activation on speaking
 - “Request” mode, delegate requests to speak by pressing microphone On/Off button, delegate only speaks when operator or chairman approved his application
 - “PTT” mode, press microphone On/Off button to talk
 - ◆ Simultaneous interpretation
- Key-press sign-in
- Automatic video tracking implementation when cooperating with cameras & video switcher unit; preset positions on PC

- Set any delegate unit to be VIP unit
 - ◆ Up to 32 units can be set as VIP in one system via application software
 - ◆ VIP unit can be activated as long as the total of active microphones is not beyond 8 (incl. chairman/delegate/VIP unit)

Controls and Indicators

- Graphic 128x36 OLED with screen saver for displaying:
 - ◆ Channel number and language name
- Built-in channel selector with up/down channel select buttons
- Uni-directional electret condenser microphone with two-color illuminated ring
- Headphone volume up and down
- Microphone On/Off button with indicator

Interconnections

- Socket for pluggable microphone
- Ø 3.5 mm stereo headphone jack
- 2 × RJ45 socket for daisy chain connection (recommended use of cat5e cable with a drain wire & RJ45 plug with metal shield)

Technical Specifications

Electrical

Max. consumption.....2.0 W

Headphone connection

Frequency response.....20 Hz to 20 kHz

Earphone load impedance.....>16 Ohm

Earphone output.....10 mW

Recommended microphone type

Transducer.....Electret-condenser

Polar pattern.....Uni-directional

Operating voltage.....5 VDC

Sensitivity.....-46 dBV/Pa

Frequency response.....50 Hz to 20 kHz

Input impedance.....2 kOhm

Directivity 0°/180°.....> 20 dB (1 kHz)

Equivalent noise.....20 dBA (SPL)

Maximum sound pressure level.....125 dB (THD<3%)

Interface data

Connector.....Ø 3.5 mm stereo jack for headphone

Mechanical

Mounting.....Flush-mounting

Dimensions (h x w x d) (w/o stem microphone).....54 x 245 x 80 mm

Weight (incl. stem microphone).....0.8 kg

Color.....Black (PANTONE 419 C)

Stem length.....330 mm, 410 mm (standard version), 470 mm

Ordering Information

HCS-48U10DS/80..... Fully Digital Congress System Delegate Unit (flush-mounting, discussion, 64 CHs, OLED, black)

HCS-48U10DDS/80 Delegate Unit with Dual Channel Selection



Features

- Elegant and ergonomic design
- Hi-Fi loudspeaker
- Pluggable microphone
- OLED screen with high brightness and contrast, wide viewing angle and low power consumption
- "Closed Loop - Daisy Chain" connection topology
- Transmitting up to 64 CHs high quality digital audio signals on a dedicated 8-pin cable
- Supporting 48 kHz audio sampling rate, all 64 channels perfectly reproducing audio frequencies between 20 Hz and 20 kHz
- Built-in dual channel selectors consist of up/down channel select buttons and SI information display
- The microphone buttons provide dual delegate identification, used for individual delegate identification on the left and right respectively and easy for automatic video tracking
- Excellent immunity to RF interference from mobile phones
- Separate adjustment of gain and EQ (5 band) of each microphone for the perfect sound
- Supporting "PnP" (plug and play)

The multi-functional delegate unit meets the demands of even the largest conferences. It provides facilities for speaking, listening, and selecting language channels. Excellent immunity to RF interference from mobile phones. It features dual channel selectors, the microphone buttons provide dual delegate identification, used for individual delegate identification on the left and right. A graphic OLED screen can display operation menu, channel number and language name. Channel selection is automatically limited to the number of language channels available.

The loudspeaker offers superior acoustics with minimal feedback for enhanced intelligibility.

Functions

- Compliant to ISO 22259
- "Closed Loop - Daisy Chain" connection topology for a high operational system reliability: breakdown or replacement of a congress unit and connection failure of a cable will not influence other congress units in the system
- Based on TAIDEN originated MCA-STREAM digital audio processing and transmitting technologies
- Proprietary MCA-STREAM technology used to transmit fully digital audio between the congress units as well as between congress units and main unit(s)
- Audio signals processed by high performance DSP: sound quality approaching CD quality
- Gain and EQ (5 band) of each microphone adjustable separately, fitting the individual orator's voice to achieve perfect speech pickup any time
- Transmitting up to 64 CHs high quality digital audio signals on a dedicated cable (recommended use of cat5e cable with a drain wire)
- Supporting 48 kHz audio sampling rate, all 64 channels perfectly reproducing audio frequencies between 20 Hz and 20 kHz
- The microphone buttons provide dual delegate identification, used for individual delegate identification on the left and right respectively and easy for automatic video tracking
- Integrated high-pass filter (low-cut switch) to cut low frequency elements from the audio when needed
- Automatic system recovery and "PnP" (plug and play)
- Stem microphone can be unplugged during adjournment, easy to maintain
- Mini-microphone, built-in foam windshield
- Hi-Fi loudspeaker, minimal feedback, mutes automatically when microphone is active
- Excellent immunity to RF interference from mobile phones and comparable devices
- Two microphone On/Off buttons
- Facilities in independent operation from computer:
 - ◆ Set the number of delegates permitted to speak at the same time
 - ◆ Speak mode: Open/Override/Voice/Request/PTT
 - "Open" mode, microphone On/Off button with request-to-speak registration (AUTO)
 - "Override" mode, microphone On/Off button control with override of the active microphones (FIFO)
 - "Voice" mode, acoustic active sensitivity and automatic switch-off time adjustable continuously, built-in "flash-on" technology, immediate microphone activation on speaking
 - "Request" mode, delegate requests to speak by pressing microphone On/Off button, delegate only speaks when operator or chairman approved his application
 - "PTT" mode, press microphone On/Off button to talk
 - ◆ Simultaneous interpretation
- Automatic video tracking implementation when cooperating with cameras & video switcher unit; preset positions on PC
- Set any delegate unit to be VIP unit
 - ◆ Up to 32 units can be set as VIP in one system via application software
 - ◆ VIP unit can be activated as long as the total of active microphones is not beyond 8 (incl. chairman/delegate/VIP unit)

Controls and Indicators

- Graphic 128x36 OLED with screen saver for displaying:
 - ◆ Channel number and language name
- Built-in two channel selectors consist of up/down channel select buttons and channel indicator display
- Uni-directional electret condenser microphone with two-color illuminated ring
- Headphones volume up and down
- Two microphone On/Off buttons

Interconnections

- Socket for pluggable microphone
- 2 × Ø 3.5 mm stereo headphone jack
- 2 × RJ45 socket for daisy chain connection (recommended use of cat5e cable with a drain wire & RJ45 plug with metal shield)

Technical Specifications

Electrical

Max. consumption 2.0 W

Headphone connection

Frequency response 20 Hz to 20 kHz

Earphone load impedance >16 Ohm

Earphone output 10 mW

Recommended microphone type

Transducer Electret-condenser

Polar pattern Uni-directional

Operating voltage 5 VDC

Sensitivity -46 dBV/Pa

Frequency response 50 Hz to 20 kHz

Input impedance 2 kOhm

Directivity 0°/180° > 20 dB (1 kHz)

Equivalent noise 20 dBA (SPL)

Maximum sound pressure level 125 dB (THD<3%)

Interface data

Connector 2 x Ø 3.5 mm stereo jack for headphone

Mechanical

Mounting Flush-mounting

Dimensions (h x w x d) (w/o stem microphone) 54 x 245 x 80 mm

Weight (incl. stem microphone) 0.8 kg

Color Black (PANTONE 419 C)

Stem length 330 mm, 410 mm (standard version), 470 mm

Ordering Information

HCS-48U10DDS/80 Fully Digital Congress System Delegate Unit (flush-mounting, discussion, 64 CHs, OLED, 2 channel selectors, dual predefined position, black)

HCS-4860CS/80 Chairman Unit with Channel Selection



Features

- **Elegant and ergonomic design**
- **Rectangular columnar microphone, the pitching angle of the microphone is adjustable**
- **Priority button and apply button**
- **OLED screen with high brightness and contrast, wide viewing angle and low power consumption**
- **“Closed Loop - Daisy Chain” connection topology**
- **Transmitting up to 64 CHs high quality digital audio signals on a dedicated 8-pin cable**
- **Supporting 48 kHz audio sampling rate, all 64 channels perfectly reproducing audio frequencies between 20 Hz and 20 kHz**
- **Built-in channel selector consists of up/down channel select buttons and SI information display**
- **Excellent immunity to RF interference from mobile phones**
- **Separate adjustment of gain and EQ (5 band) of each microphone for the perfect sound**
- **Supporting “PnP” (plug and play)**

The stylish and ergonomically designed chairman unit has all the necessary facilities to enable the user to chair a conference. It has excellent immunity to RF interference from mobile phones. Similar in appearance to HCS-4860DS/80 Delegate Unit, the HCS-4860CS/80 Chairman Unit includes a microphone priority button. When pressed, the priority button causes all currently active delegate microphones to be switched off temporarily or permanently, allowing the chairman to take control of the meeting. The chairman unit can also be used to apply/cancel a request-to-speak and turn off all active microphones.

Functions

- Compliant to ISO 22259
- “Closed Loop - Daisy Chain” connection topology for a high operational system reliability: breakdown or replacement of a congress unit and connection failure of a cable will not influence other congress units
- Based on TAIDEN originated MCA-STREAM digital audio processing and transmitting technologies
- Proprietary MCA-STREAM technology used to transmit fully digital audio between the congress units as well as between congress units and main unit(s)
- Audio signals processed by high performance DSP: sound quality approaching CD quality
- Gain and EQ (5 band) of each microphone adjustable separately, fitting the individual orator's voice to achieve perfect speech pickup any time
- Transmitting up to 64 CHs high quality digital audio signals on a dedicated 8-pin cable (general cat5e cable with a drain wire substitutable)
- Supporting 48 kHz audio sampling rate, all 64 channels perfectly reproducing audio frequencies between 20 Hz and 20 kHz
- Integrated high-pass filter (low-cut switch) to cut low frequency elements from the audio when needed
- Automatic system recovery and “PnP” (plug and play)
- Hypercardioid uni-directional electret condenser microphone with bi-color illuminated ring
- Rectangular columnar microphone, the pitching angle of the microphone is adjustable
- Excellent immunity to RF interference from mobile phones and comparable devices
- Microphone On/Off button
- An ID can be assigned by default or manually to each conference unit bearing a unique serial number for convenient maintenance
- Facilities in independent operation from computer:
 - ◆ Set the number of delegates permitted to speak at the same time
 - ◆ Speak mode: Open/Override/Voice/Request/PTT
 - “Open” mode, microphone On/Off button with request-to-speak registration (AUTO)
 - “Override” mode, microphone On/Off button control with override of the active microphones (FIFO)
 - “Voice” mode, acoustic active sensitivity and automatic switch-off time adjustable continuously, built-in “flash-on” technology, immediate microphone activation on speaking
 - “Request” mode, delegate requests to speak by pressing microphone On/Off button, delegate only speaks when operator or chairman approved his application
 - “PTT” mode, press microphone On/Off button to talk
 - ◆ Simultaneous interpretation
- Automatic video tracking implementation when cooperating with cameras & video switcher unit; preset positions on PC
- Activation at any time (if the amount of active microphones in the system is less than 8)
- Priority button to switch off or to mute the delegate units (except VIP units) according to preset
- Approves/denies delegates' speaking request

- System supports up to 100 chairman units, while all or part chairman units have the control facilities listed above (set by software or main unit)

Controls and Indicators

- Graphic 128x36 OLED with screen saver for displaying:
 - ◆ Channel number and language name
- Hypercardioid uni-directional electret condenser microphone with two-color illuminated ring
- Built-in channel selector consists with up/down channel select buttons and SI information display
- Headphone volume up and down
- Microphone On/Off button with indicator
- Priority button with indicator
- Apply button with indicator

Interconnections

- Ø 3.5 mm stereo headphone jack
- 1.5 m cable with 8P-DIN plug
- 0.6 m cable with 8P-DIN socket

Technical Specifications

Electrical

Max. consumption.....1.8 W

Headphone connection

Frequency response.....20 Hz to 20 kHz

Earphone load impedance.....>16 Ohm

Earphone output.....10 mW

Recommended microphone type

Transducer.....Electret-condenser

Polar pattern.....Hypercardioid uni-directional

.....14mm gold-plating capacitance sound head

Operating voltage.....5 VDC

Sensitivity.....-37 dBV/Pa

Frequency response.....20 Hz to 20 kHz

Input impedance.....2 kOhm

Directivity 0°/135°.....> 20 dB (1 kHz)

Directivity 0°/180°.....> 15 dB (1 kHz)

Equivalent noise.....20 dBA (SPL)

Maximum sound pressure level.....139 dB (THD<3%)

Interface data

Connector.....Ø 3.5 mm stereo jack for headphone

Mechanical

Mounting.....Tabletop

Dimensions (h x w x d).....64 x 115 x 123 mm (base)

.....37 x 241 x 37 mm (microphone)

Weight.....1.1 kg

Color.....Black (PANTONE 419 C)

Ordering Information

HCS-4860CS_B/80.....Fully Digital Congress System Chairman Unit (tabletop, discussion, rectangular columnar metal microphone, 64 CHs, OLED, black)

HCS-4860DS/80 Delegate Unit with Channel Selection



Features

- **Elegant and ergonomic design**
- **Rectangular columnar microphone, the pitching angle of the microphone is adjustable**
- **OLED screen with high brightness and contrast, wide viewing angle and low power consumption**
- **“Closed Loop - Daisy Chain” connection topology**
- **Transmitting up to 64 CHs high quality digital audio signals on a dedicated 8-pin cable**
- **Supporting 48 kHz audio sampling rate, all 64 channels perfectly reproducing audio frequencies between 20 Hz and 20 kHz**
- **Built-in channel selector consists of up/down channel select buttons and SI information display**
- **Excellent immunity to RF interference from mobile phones**
- **Separate adjustment of gain and EQ (5 band) of each microphone for the perfect sound**
- **Supporting “PnP” (plug and play)**

The multi-functional delegate unit meets the demands of even the largest conferences. It provides facilities for speaking, registering a request-to-speak, listening and selecting language channels. Excellent immunity to RF interference from mobile phones. A graphic OLED screen can display operation menu, channel number and language name. Channel selection is automatically limited to the number of language channels available.

Functions

- Compliant to ISO 22259
- “Closed Loop - Daisy Chain” connection topology for a high operational system reliability: breakdown or replacement of a congress unit and connection failure of a cable will not influence other congress units in the system
- Based on TAIDEN originated MCA-STREAM digital audio processing and transmitting technologies
- Proprietary MCA-STREAM technology used to transmit fully digital audio between the congress units as well as between congress units and main unit(s)
- Audio signals processed by high performance DSP: sound quality approaching CD quality

- Gain and EQ (5 band) of each microphone adjustable separately, fitting the individual orator’s voice to achieve perfect speech pickup any time
- Transmitting up to 64 CHs high quality digital audio signals on a dedicated 8-pin cable (general cat5e cable with a drain wire substitutable)
- Supporting 48 kHz audio sampling rate, all 64 channels perfectly reproducing audio frequencies between 20 Hz and 20 kHz
- Integrated high-pass filter (low-cut switch) to cut low frequency elements from the audio when needed
- Automatic system recovery and “PnP” (plug and play)
- Hypercardioid uni-directional electret condenser microphone with bi-color illuminated ring
- Rectangular columnar microphone, the pitching angle of the microphone is adjustable
- Excellent immunity to RF interference from mobile phones and comparable devices
- Microphone On/Off button
- An ID can be assigned by default or manually to each conference unit bearing a unique serial number for convenient maintenance
- Facilities in independent operation from computer:
 - ◆ Set the number of delegates permitted to speak at the same time
 - ◆ Speak mode: Open/Override/Voice/Request/PTT
 - “Open” mode, microphone On/Off button with request-to-speak registration (AUTO)
 - “Override” mode, microphone On/Off button control with override of the active microphones (FIFO)
 - “Voice” mode, acoustic active sensitivity and automatic switch-off time adjustable continuously, built-in “flash-on” technology, immediate microphone activation on speaking
 - “Request” mode, delegate requests to speak by pressing microphone On/Off button, delegate only speaks when operator or chairman approved his application
 - “PTT” mode, press microphone On/Off button to talk
 - ◆ Simultaneous interpretation
- Automatic video tracking implementation when cooperating with cameras & video switcher unit; preset positions on PC
- Set any delegate unit to be VIP unit
 - ◆ Up to 32 units can be set as VIP in one system via application software
 - ◆ VIP unit can be activated as long as the total of active microphones is not beyond 8 (incl. chairman/delegate/VIP unit)

Controls and Indicators

- Graphic 128x36 OLED with screen saver for displaying:
 - ◆ Channel number and language name
- Hypercardioid uni-directional electret condenser microphone with two-color illuminated ring
- Built-in channel selector consists with up/down channel select buttons and SI information display
- Headphone volume up and down
- Microphone On/Off button with indicator

Interconnections

- Ø 3.5 mm stereo headphone jack
- 1.5 m cable with 8P-DIN plug
- 0.6 m cable with 8P-DIN socket

Technical Specifications

Electrical

Max. consumption.....1.8 W

Headphone connection

Frequency response.....20 Hz to 20 kHz

Earphone load impedance.....>16 Ohm

Earphone output.....10 mW

Recommended microphone type

Transducer.....Electret-condenser

.....14mm gold-plating capacitance sound head

Polar pattern.....Hypercardioid uni-directional

Operating voltage.....5 VDC

Sensitivity.....-37 dBV/Pa

Frequency response.....20 Hz to 20 kHz

Input impedance.....2 kOhm

Directivity 0°/135°.....> 20 dB (1 kHz)

Directivity 0°/180°.....> 15 dB (1 kHz)

Equivalent noise.....20 dBA (SPL)

Maximum sound pressure level.....139 dB (THD<3%)

Interface data

Connector.....Ø 3.5 mm stereo jack for headphone

Mechanical

Mounting.....Tabletop

Dimensions (h x w x d).....64 x 115 x 123 mm (base)

.....37 x 241 x 37 mm (microphone)

Weight.....1.1 kg

Color.....Black (PANTONE 419 C)

Ordering Information

HCS-4860DS_B/80.....Fully Digital Congress System Delegate
 Unit (tabletop, discussion, rectangular
 columnar metal microphone, 64 CHs,
 OLED, black)

HCS-4860C/80 Delegate Unit



Features

- **Elegant and ergonomic design**
- **Rectangular columnar microphone, the pitching angle of the microphone is adjustable**
- **Priority button**
- **Apply button**
- **“Closed Loop - Daisy Chain” connection topology**
- **Supporting 48 kHz audio sampling rate**
- **Excellent immunity to RF interference from mobile phones**
- **Separate adjustment of gain and EQ (5 band) of each microphone for the perfect sound**
- **Supporting “PnP” (plug and play)**

The stylish and ergonomically designed chairman unit has all the necessary facilities to enable the user to chair a conference. It has excellent immunity to RF interference from mobile phones. Similar in appearance to HCS-4860D/80 Delegate Unit, the HCS-4860C/80 Chairman Unit includes a microphone priority button. When pressed, the priority button causes all currently active delegate microphones to be switched off temporarily or permanently, allowing the chairman to take control of the meeting. The chairman unit can also be used to apply/cancel a request-to-speak and turn off all active microphones.

Functions

- Compliant to ISO 22259
- “Closed Loop - Daisy Chain” connection topology for a high operational system reliability: breakdown or replacement of a congress unit and connection failure of a cable will not influence other congress units
- Based on TAIDEN originated MCA-STREAM digital audio processing and transmitting technologies
- Proprietary MCA-STREAM technology used to transmit fully digital audio between the congress units as well as between congress units and main unit(s)
- Audio signals processed by high performance DSP: sound quality approaching CD quality
- Gain and EQ (5 band) of each microphone adjustable separately, fitting the individual orator’s voice to achieve perfect speech pickup any time
- Supporting 48 kHz audio sampling rate

- Integrated high-pass filter (low-cut switch) to cut low frequency elements from the audio when needed
- Automatic system recovery and “PnP” (plug and play)
- Hypercardioid uni-directional electret condenser microphone with bi-color illuminated ring
- Rectangular columnar microphone, the pitching angle of the microphone is adjustable
- Excellent immunity to RF interference from mobile phones and comparable devices
- Microphone On/Off button
- An ID can be assigned by default or manually to each conference unit bearing a unique serial number for convenient maintenance
- Facilities in independent operation from computer:
 - ◆ Set the number of delegates permitted to speak at the same time
 - ◆ Speak mode: Open/Override/Voice/Request/PTT
 - “Open” mode, microphone On/Off button with request-to-speak registration (AUTO)
 - “Override” mode, microphone On/Off button control with override of the active microphones (FIFO)
 - “Voice” mode, acoustic active sensitivity and automatic switch-off time adjustable continuously, built-in “flash-on” technology, immediate microphone activation on speaking
 - “Request” mode, delegate requests to speak by pressing microphone On/Off button, delegate only speaks when operator or chairman approved his application
 - “PTT” mode, press microphone On/Off button to talk
- Automatic video tracking implementation when cooperating with cameras & video switcher unit; preset positions on PC
- Activation at any time (if the amount of active microphones in the system is less than 8)
- Priority button to switch off or to mute the delegate units (except VIP units) according to preset
- Approves/denies delegates’ speaking request
- System supports up to 100 chairman units, while all or part chairman units have the control facilities listed above (set by software or main unit)

Controls and Indicators

- Hypercardioid uni-directional electret condenser microphone with two-color illuminated ring
- Microphone On/Off button with indicator
- Priority button with indicator
- Apply button with indicator

Interconnections

- Ø 3.5 mm stereo headphone jack
- 1.5 m cable with 8P-DIN plug
- 0.6 m cable with 8P-DIN socket

Technical Specifications

Electrical

Max. consumption.....	1.8 W
Headphone connection	
Frequency response.....	20 Hz to 20 kHz
Earphone load impedance.....	>16 Ohm
Earphone output.....	10 mW

HCS-4860D/80 Delegate Unit



Features

- **Elegant and ergonomic design**
- **Rectangular columnar microphone, the pitching angle of the microphone is adjustable**
- **“Closed Loop - Daisy Chain” connection topology**
- **Supporting 48 kHz audio sampling rate**
- **Excellent immunity to RF interference from mobile phones**
- **Separate adjustment of gain and EQ (5 band) of each microphone for the perfect sound**
- **Supporting “PnP” (plug and play)**

The multi-functional delegate unit meets the demands of even the largest conferences. It provides facilities for speaking, registering a request-to-speak, registering a request-to-respond and listening. Excellent immunity to RF interference from mobile phones.

Functions

- Compliant to ISO 22259
- “Closed Loop - Daisy Chain” connection topology for a high operational system reliability: breakdown or replacement of a congress unit and connection failure of a cable will not influence other congress units in the system
- Based on TAIDEN originated MCA-STREAM digital audio processing and transmitting technologies
- Proprietary MCA-STREAM technology used to transmit fully digital audio between the congress units as well as between congress units and main unit(s)
- Audio signals processed by high performance DSP: sound quality approaching CD quality
- Gain and EQ (5 band) of each microphone adjustable separately, fitting the individual orator’s voice to achieve perfect speech pickup any time
- Supporting 48 kHz audio sampling rate
- Integrated high-pass filter (low-cut switch) to cut low frequency elements from the audio when needed
- Automatic system recovery and “PnP” (plug and play)
- Hypercardioid uni-directional electret condenser microphone with bi-color illuminated ring
- Rectangular columnar microphone, the pitching angle of the microphone is adjustable
- Excellent immunity to RF interference from mobile phones and comparable devices

- Microphone On/Off button
- An ID can be assigned by default or manually to each conference unit bearing a unique serial number for convenient maintenance
- Facilities in independent operation from computer:
 - ◆ Set the number of delegates permitted to speak at the same time
 - ◆ Speak mode: Open/Override/Voice/Request/PTT
 - “Open” mode, microphone On/Off button with request-to-speak registration (AUTO)
 - “Override” mode, microphone On/Off button control with override of the active microphones (FIFO)
 - “Voice” mode, acoustic active sensitivity and automatic switch-off time adjustable continuously, built-in “flash-on” technology, immediate microphone activation on speaking
 - “Request” mode, delegate requests to speak by pressing microphone On/Off button, delegate only speaks when operator or chairman approved his application
 - “PTT” mode, press microphone On/Off button to talk
- Automatic video tracking implementation when cooperating with cameras & video switcher unit; preset positions on PC
- Set any delegate unit to be VIP unit
 - ◆ Up to 32 units can be set as VIP in one system via application software
 - ◆ VIP unit can be activated as long as the total of active microphones is not beyond 8 (incl. chairman/delegate/VIP unit)

Controls and Indicators

- Hypercardioid uni-directional electret condenser microphone with two-color illuminated ring
- Microphone On/Off button with indicator

Interconnections

- Ø 3.5 mm stereo headphone jack
- 1.5 m cable with 8P-DIN plug
- 0.6 m cable with 8P-DIN socket

Technical Specifications

Electrical

Max. consumption.....1.8 W

Headphone connection

Frequency response.....20 Hz to 20 kHz

Earphone load impedance.....>16 Ohm

Earphone output.....10 mW

Recommended microphone type

Transducer.....Electret-condenser

Polar pattern.....Hypercardioid uni-directional

.....14mm gold-plating capacitance sound head

Operating voltage.....5 VDC

Sensitivity.....-37 dBV/Pa

Frequency response.....20 Hz to 20 kHz

Input impedance.....2 kOhm

Directivity 0°/135°.....> 20 dB (1 kHz)

Directivity 0°/180°.....> 15 dB (1 kHz)

Equivalent noise.....20 dBA (SPL)

Maximum sound pressure level.....139 dB (THD<3%)

Interface data

Connector.....Ø 3.5 mm stereo jack for headphone

Mechanical

Mounting.....Tabletop
Dimensions (h x w x d).....64 x 115 x 123 mm (base)
.....37 x 241 x 37 mm (microphone)
Weight.....1.1 kg
Color.....Black (PANTONE 419 C)

Ordering Information

HCS-4860D_B/80.....Fully Digital Congress System Delegate Unit
(tabletop, discussion, rectangular columnar
metal microphone, black)

HCS-4860C/80/2M Delegate Unit



Features

- **Elegant and ergonomic design**
- **Rectangular columnar microphone, the pitching angle of the microphone is adjustable**
- **Built-in isolated main microphone and backup microphone**
- **Priority button and apply button**
- **"Closed Loop - Daisy Chain" connection topology**
- **Excellent immunity to RF interference from mobile phones**
- **Separate adjustment of gain and EQ (5 band) of each microphone for the perfect sound**
- **Supporting "PnP" (plug and play)**

The stylish and ergonomically designed chairman unit has all the necessary facilities to enable the user to chair a conference. It has excellent immunity to RF interference from mobile phones. Similar in appearance to HCS-4860D/80/2M Delegate Unit, the HCS-4860C/80/2M Chairman Unit includes a microphone priority button. When pressed, the priority button causes all currently active delegate microphones to be switched off temporarily or permanently, allowing the chairman to take control of the meeting. The chairman unit can also be used to apply/cancel a request-to-speak and turn off all active microphones.

Functions

- Compliant to ISO 22259
- "Closed Loop - Daisy Chain" connection topology for a high

operational system reliability: breakdown or replacement of a congress unit and connection failure of a cable will not influence other congress units in the system

- Based on TAIDEN originated MCA-STREAM digital audio processing and transmitting technologies
- Proprietary MCA-STREAM technology used to transmit fully digital audio between the congress units as well as between congress units and main unit(s)
- Audio signals processed by high performance DSP: sound quality approaching CD quality
- Hypercardioid uni-directional electret condenser microphone with two-color illuminated ring
- Rectangular columnar microphone, the pitching angle of the microphone is adjustable
- Built-in an electrets main microphone and a backup microphone both with hypercardioid polar pattern. In case the main microphone system malfunctions, the backup microphone system can take over to ensure an uninterrupted meeting flow
- Gain and EQ (5 band) of each microphone adjustable separately, fitting the individual orator's voice to achieve perfect speech pickup any time
- Integrated high-pass filter (low-cut switch) to cut low frequency elements from the audio when needed
- Automatic system recovery and "PnP" (plug and play)
- Excellent immunity to RF interference from mobile phones and comparable devices
- Microphone On/Off button
- An ID can be assigned by default or manually to each conference unit bearing a unique serial number for convenient maintenance
- Facilities in independent operation from computer:
 - ◆ Set the number of delegates permitted to speak at the same time
 - ◆ Speak mode: Open/Override/Voice/Request/PTT
 - "Open" mode, microphone On/Off button with request-to-speak registration (AUTO)
 - "Override" mode, microphone On/Off button control with override of the active microphones (FIFO)
 - "Voice" mode, acoustic active sensitivity and automatic switch-off time adjustable continuously, built-in "flash-on" technology, immediate microphone activation on speaking
 - "Request" mode, delegate requests to speak by pressing microphone On/Off button, delegate only speaks when operator or chairman approved his application
 - "PTT" mode, press microphone On/Off button to talk
- Automatic video tracking implementation when cooperating with cameras & video switcher unit; preset positions on PC
- Activation at any time (if the amount of active microphones in the system is less than 8)
- Priority button to switch off or to mute the delegate units (except VIP units) according to preset
- Approves/denies delegates' speaking request
- System supports up to 100 chairman units, while all or part chairman units have the control facilities listed above (set by software or main unit)

Controls and Indicators

- Hypercardioid uni-directional electret condenser microphone with two-color illuminated ring

- Microphone On/Off button with indicator
- Priority button with indicator
- Apply button with indicator

Interconnections

- Ø 3.5 mm stereo headphone jack
- 1.5 m cable with 8P-DIN plug
- 0.6 m cable with 8P-DIN socket
- XLR connector for backup by connecting to the audio mixer

Technical Specifications

Electrical

Max. consumption.....1.8 W

Headphone connection

Frequency response.....20 Hz to 20 kHz

Earphone load impedance.....>16 Ohm

Earphone output.....10 mW

Main microphone type

Transducer.....Electret-condenser

Polar pattern.....Hypercardioid uni-directional
.....14mm gold-plating capacitance sound head

Operating voltage.....5 VDC

Sensitivity.....-37 dBV/Pa

Frequency response.....20 Hz to 20 kHz

Input impedance.....2 kOhm

Directivity 0°/135°.....> 20 dB (1 kHz)

Directivity 0°/180°.....> 15 dB (1 kHz)

Equivalent noise.....20 dBA (SPL)

Maximum sound pressure level.....139 dB (THD<3%)

Backup microphone type

Transducer.....Electret-condenser

Polar pattern.....Hypercardioid uni-directional

Phantom power.....11~52 VDC, 2 mA

Sensitivity.....-38 dBV/Pa

Frequency response.....50 Hz to 20 kHz

Output impedance.....280 Ohm

Directivity 0°/135°.....> 20 dB (1 kHz)

Directivity 0°/180°.....> 15 dB (1 kHz)

Equivalent noise.....20 dBA (SPL)

Maximum sound pressure level.....139 dB (THD<3%)

Connection.....XLRM-type connector

Interface data

Connector.....Ø 3.5 mm stereo jack for headphone

Mechanical

Mounting.....Tabletop

Dimensions (h x w x d).....64 x 115 x 123 mm (base)

.....37 x 249 x 37 mm (microphone)

Weight.....1.2 kg

Color.....Black (PANTONE 419 C)

Ordering Information

HCS-4860C_B/80/2M...Fully Digital Congress System Chairman
Unit (tabletop, discussion, rectangular
columnar metal microphone, main
microphone + backup microphone,
black)

HCS-4860D/80/2M Delegate Unit



Features

- **Elegant and ergonomic design**
- **Rectangular columnar microphone, the pitching angle of the microphone is adjustable**
- **Built-in isolated main microphone and backup microphone**
- **“Closed Loop - Daisy Chain” connection topology**
- **Excellent immunity to RF interference from mobile phones**
- **Separate adjustment of gain and EQ (5 band) of each microphone for the perfect sound**
- **Supporting “PnP” (plug and play)**

The multi-functional delegate unit meets the demands of even the largest conferences. It provides facilities for speaking, registering a request-to-speak, listening and selecting language channels. Excellent immunity to RF interference from mobile phones.

Functions

- Compliant to ISO 22259
- “Closed Loop - Daisy Chain” connection topology for a high operational system reliability: breakdown or replacement of a congress unit and connection failure of a cable will not influence other congress units in the system
- Based on TAIDEN originated MCA-STREAM digital audio processing and transmitting technologies
- Proprietary MCA-STREAM technology used to transmit fully digital audio between the congress units as well as between congress units and main unit(s)
- Audio signals processed by high performance DSP: sound quality approaching CD quality

- Hypercardioid uni-directional electret condenser microphone with two-color illuminated ring
- Rectangular columnar microphone, the pitching angle of the microphone is adjustable
- Built-in an electrets main microphone and a backup microphone both with hypercardioid polar pattern. In case the main microphone system malfunctions, the backup microphone system can take over to ensure an uninterrupted meeting flow
- Gain and EQ (5 band) of each microphone adjustable separately, fitting the individual orator’s voice to achieve perfect speech pickup any time
- Integrated high-pass filter (low-cut switch) to cut low frequency elements from the audio when needed
- Automatic system recovery and “PnP” (plug and play)
- Excellent immunity to RF interference from mobile phones and comparable devices
- Microphone On/Off button
- An ID can be assigned by default or manually to each conference unit bearing a unique serial number for convenient maintenance
- Facilities in independent operation from computer:
 - ◆ Set the number of delegates permitted to speak at the same time
 - ◆ Speak mode: Open/Override/Voice/Request/PTT
 - “Open” mode, microphone On/Off button with request-to-speak registration (AUTO)
 - “Override” mode, microphone On/Off button control with override of the active microphones (FIFO)
 - “Voice” mode, acoustic active sensitivity and automatic switch-off time adjustable continuously, built-in “flash-on” technology, immediate microphone activation on speaking
 - “Request” mode, delegate requests to speak by pressing microphone On/Off button, delegate only speaks when operator or chairman approved his application
 - “PTT” mode, press microphone On/Off button to talk
- Automatic video tracking implementation when cooperating with cameras & video switcher unit; preset positions on PC
- Set any delegate unit to be VIP unit
 - ◆ Up to 32 units can be set as VIP in one system via application software
 - ◆ VIP unit can be activated as long as the total of active microphones is not beyond 8 (incl. chairman/delegate/VIP unit)

Controls and Indicators

- Hypercardioid uni-directional electret condenser microphone with two-color illuminated ring
- Microphone On/Off button with indicator

Interconnections

- Ø 3.5 mm stereo headphone jack
- 1.5 m cable with 8P-DIN plug
- 0.6 m cable with 8P-DIN socket
- XLR connector for backup by connecting to the audio mixer

Technical Specifications

Electrical

Max. consumption.....1.8 W

Headphone connection

Frequency response.....20 Hz to 20 kHz

Earphone load impedance.....>16 Ohm

Earphone output.....10 mW

Main microphone type

Transducer.....Electret-condenser

Polar pattern.....Hypercardioid uni-directional
.....14mm gold-plating capacitance sound head

Operating voltage.....5 VDC

Sensitivity.....-37 dBV/Pa

Frequency response.....20 Hz to 20 kHz

Input impedance.....2 kOhm

Directivity 0°/135°.....> 20 dB (1 kHz)

Directivity 0°/180°.....> 15 dB (1 kHz)

Equivalent noise.....20 dBA (SPL)

Maximum sound pressure level.....139 dB (THD<3%)

Backup microphone type

Transducer.....Electret-condenser

Polar pattern.....Hypercardioid uni-directional
.....14mm gold-plating capacitance sound head

Phantom power.....11~52 VDC, 2 mA

Sensitivity.....-37 dBV/Pa

Frequency response.....20 Hz to 20 kHz

Output impedance.....280 Ohm

Directivity 0°/135°.....> 20 dB (1 kHz)

Directivity 0°/180°.....> 15 dB (1 kHz)

Equivalent noise.....20 dBA (SPL)

Maximum sound pressure level.....139 dB (THD<3%)

Connection.....XLRM-type connector

Interface data

Connector.....Ø 3.5 mm stereo jack for headphone

Mechanical

Mounting.....Tabletop

Dimensions (h x w x d).....64 x 115 x 123 mm (base)
.....37 x 249 x 37 mm (microphone)

Weight.....1.2 kg

Color.....Black (PANTONE 419 C)

Ordering Information

HCS-4860D_B/80/2M.....Fully Digital Congress System Delegate
Unit (tabletop, discussion, rectangular
columnar metal microphone, main
microphone + backup microphone,
black)

HCS-4860CX_B/80 Delegate Unit



Features

- Elegant and ergonomic design
- XLR connector for condenser microphone with +48 V phantom power
- Priority button
- Apply button
- "Closed Loop - Daisy Chain" connection topology
- Supporting 48 kHz audio sampling rate
- Excellent immunity to RF interference from mobile phones
- Separate adjustment of gain and EQ (5 band) of each microphone for the perfect sound
- Supporting "PnP" (plug and play)

The stylish and ergonomically designed chairman unit has all the necessary facilities to enable the user to chair a conference. It has excellent immunity to RF interference from mobile phones. Similar in appearance to HCS-4860DX_B/80 Delegate Unit, the HCS-4860CX_B/80 Chairman Unit includes a microphone priority button. When pressed, the priority button causes all currently active delegate microphones to be switched off temporarily or permanently, allowing the chairman to take control of the meeting. The chairman unit can also be used to apply/cancel a request-to-speak and turn off all active microphones.

Functions

- Compliant to ISO 22259
- "Closed Loop - Daisy Chain" connection topology for a high operational system reliability: breakdown or replacement of a congress unit and connection failure of a cable will not influence other congress units
- Based on TAIDEN originated MCA-STREAM digital audio processing and transmitting technologies
- Proprietary MCA-STREAM technology used to transmit fully digital audio between the congress units as well as between congress units and main unit(s)
- Audio signals processed by high performance DSP: sound quality approaching CD quality
- Gain and EQ (5 band) of each microphone adjustable separately, fitting the individual orator's voice to achieve perfect speech pickup any time
- Supporting 48 kHz audio sampling rate
- Integrated high-pass filter (low-cut switch) to cut low frequency elements from the audio when needed
- Automatic system recovery and "PnP" (plug and play)

- XLR connector for condenser microphone with +48 V phantom power
- Excellent immunity to RF interference from mobile phones and comparable devices
- Microphone On/Off button
- An ID can be assigned by default or manually to each conference unit bearing a unique serial number for convenient maintenance
- Facilities in independent operation from computer:
 - ◆ Set the number of delegates permitted to speak at the same time
 - ◆ Speak mode: Open/Override/Voice/Request/PTT
 - "Open" mode, microphone On/Off button with request-to-speak registration (AUTO)
 - "Override" mode, microphone On/Off button control with override of the active microphones (FIFO)
 - "Voice" mode, acoustic active sensitivity and automatic switch-off time adjustable continuously, built-in "flash-on" technology, immediate microphone activation on speaking
 - "Request" mode, delegate requests to speak by pressing microphone On/Off button, delegate only speaks when operator or chairman approved his application
 - "PTT" mode, press microphone On/Off button to talk
- Automatic video tracking implementation when cooperating with cameras & video switcher unit; preset positions on PC
- Activation at any time (if the amount of active microphones in the system is less than 8)
- Priority button to switch off or to mute the delegate units (except VIP units) according to preset
- Approves/denies delegates' speaking request
- System supports up to 100 chairman units, while all or part chairman units have the control facilities listed above (set by software or main unit)

Controls and Indicators

- Microphone On/Off button with indicator
- Priority button with indicator
- Apply button with indicator

Interconnections

- XLR connector for condenser microphone with +36 V phantom power
- Ø 3.5 mm stereo headphone jack
- 1.5 m cable with 8P-DIN plug
- 0.6 m cable with 8P-DIN socket

Technical Specifications

Electrical

Max. consumption.....1.8 W

Headphone connection

Frequency response.....20 Hz to 20 kHz

Earphone load impedance.....>16 Ohm

Earphone output.....10 mW

Interface data

Connector.....Ø 3.5 mm stereo jack for headphone

Mechanical

Mounting.....Tabletop
 Dimensions (h x w x d).....41 x 115 x 123 mm
 Weight.....0.7 kg
 Color.....Black (PANTONE 419 C)

Ordering Information

HCS-4860CX_B/80...Fully Digital Congress System Chairman Unit
 (tabletop, discussion, XLR connector for
 condenser microphone with +48V phantom
 power, black, without microphone,
 HCS-1857/HCS-1858 is needed)

HCS-4860DX_B/80 Delegate Unit



Features

- Elegant and ergonomic design
- XLR connector for condenser microphone with +48 V phantom power
- "Closed Loop - Daisy Chain" connection topology
- Supporting 48 kHz audio sampling rate
- Excellent immunity to RF interference from mobile phones
- Separate adjustment of gain and EQ (5 band) of each microphone for the perfect sound
- Supporting "PnP" (plug and play)

The multi-functional delegate unit meets the demands of even the largest conferences. It provides facilities for speaking, registering a request-to-speak, registering a request-to-respond and listening. Excellent immunity to RF interference from mobile phones.

Functions

- Compliant to ISO 22259
- "Closed Loop - Daisy Chain" connection topology for a high operational system reliability: breakdown or replacement of a congress unit and connection failure of a cable will not influence other congress units in the system
- Based on TAIDEN originated MCA-STREAM digital audio processing and transmitting technologies
- Proprietary MCA-STREAM technology used to transmit fully digital audio between the congress units as well as between congress units and main unit(s)
- Audio signals processed by high performance DSP: sound quality approaching CD quality
- Gain and EQ (5 band) of each microphone adjustable separately, fitting the individual orator's voice to achieve perfect speech pickup any time
- Supporting 48 kHz audio sampling rate
- Integrated high-pass filter (low-cut switch) to cut low frequency elements from the audio when needed
- Automatic system recovery and "PnP" (plug and play)
- XLR connector for condenser microphone with +48 V phantom power
- Excellent immunity to RF interference from mobile phones and comparable devices
- Microphone On/Off button
- An ID can be assigned by default or manually to each conference unit bearing a unique serial number for convenient maintenance

- Facilities in independent operation from computer:
 - ◆ Set the number of delegates permitted to speak at the same time
 - ◆ Speak mode: Open/Override/Voice/Request/PTT
 - "Open" mode, microphone On/Off button with request-to-speak registration (AUTO)
 - "Override" mode, microphone On/Off button control with override of the active microphones (FIFO)
 - "Voice" mode, acoustic active sensitivity and automatic switch-off time adjustable continuously, built-in "flash-on" technology, immediate microphone activation on speaking
 - "Request" mode, delegate requests to speak by pressing microphone On/Off button, delegate only speaks when operator or chairman approved his application
 - "PTT" mode, press microphone On/Off button to talk
- Key-press sign-in
- Automatic video tracking implementation when cooperating with cameras & video switcher unit; preset positions on PC
- Set any delegate unit to be VIP unit
 - ◆ Up to 32 units can be set as VIP in one system via application software
 - ◆ VIP unit can be activated as long as the total of active microphones is not beyond 8 (incl. chairman/delegate/VIP unit)

Controls and Indicators

- Microphone On/Off button with indicator

Interconnections

- XLR connector for condenser microphone with +48 V phantom power
- Ø 3.5 mm stereo headphone jack
- 1.5 m cable with 8P-DIN plug
- 0.6 m cable with 8P-DIN socket

Technical Specifications

Electrical

Max. consumption.....1.8 W

Headphone connection

Frequency response.....20 Hz to 20 kHz

Earphone load impedance.....>16 Ohm

Earphone output.....10 mW

Interface data

Connector.....Ø 3.5 mm stereo jack for headphone

Mechanical

Mounting.....Tabletop

Dimensions (h x w x d).....41 x 115 x 123 mm

Weight.....0.7 kg

Color.....Black (PANTONE 419 C)

Ordering Information

HCS-4860DX_B/80...Fully Digital Congress System Delegate Unit (tabletop, discussion, XLR connector for condenser microphone with +48V phantom power, black, without microphone, HCS-1857/HCS-1858 is needed)

Function List

Model No.	Type	Speech	Main Unit	Cable
HCS-4860CX/80	Chairman	√	HCS-4800MA/20 HCS-4800MB/20	8-pin dedicated cable
HCS-4860DX/80	Delegate	√	HCS-4800MC	

HCS-4860CXD/80 Delegate Unit



Features

- Elegant and ergonomic design
- XLR connector for condenser microphone with +48 V phantom power
- Priority button
- Apply button
- "Closed Loop - Daisy Chain" connection topology
- Supporting 48 kHz audio sampling rate
- Excellent immunity to RF interference from mobile phones
- Separate adjustment of gain and EQ (5 band) of each microphone for the perfect sound
- Supporting "PnP" (plug and play)

The stylish and ergonomically designed chairman unit has all the necessary facilities to enable the user to chair a conference. It has excellent immunity to RF interference from mobile phones. Similar in appearance to HCS-4860DX_B/80 Delegate Unit, the HCS-4860CX_B/80 Chairman Unit includes a microphone priority button. When pressed, the priority button causes all currently active delegate microphones to be switched off temporarily or permanently, allowing the chairman to take control of the meeting. The chairman unit can also be used to apply/cancel a request-to-speak and turn off all active microphones.

Functions

- Compliant to ISO 22259
- "Closed Loop - Daisy Chain" connection topology for a high operational system reliability: breakdown or replacement of a congress unit and connection failure of a cable will not influence other congress units
- Based on TAIDEN originated MCA-STREAM digital audio processing and transmitting technologies
- Proprietary MCA-STREAM technology used to transmit fully digital audio between the congress units as well as between congress units and main unit(s)
- Audio signals processed by high performance DSP: sound quality approaching CD quality
- Gain and EQ (5 band) of each microphone adjustable separately, fitting the individual orator's voice to achieve perfect speech pickup any time
- Supporting 48 kHz audio sampling rate
- Integrated high-pass filter (low-cut switch) to cut low frequency elements from the audio when needed
- Automatic system recovery and "PnP" (plug and play)

- XLR connector for condenser microphone with +48 V phantom power
- Excellent immunity to RF interference from mobile phones and comparable devices
- Microphone On/Off button
- An ID can be assigned by default or manually to each conference unit bearing a unique serial number for convenient maintenance
- Facilities in independent operation from computer:
 - ◆ Set the number of delegates permitted to speak at the same time
 - ◆ Speak mode: Open/Override/Voice/Request/PTT
 - "Open" mode, microphone On/Off button with request-to-speak registration (AUTO)
 - "Override" mode, microphone On/Off button control with override of the active microphones (FIFO)
 - "Voice" mode, acoustic active sensitivity and automatic switch-off time adjustable continuously, built-in "flash-on" technology, immediate microphone activation on speaking
 - "Request" mode, delegate requests to speak by pressing microphone On/Off button, delegate only speaks when operator or chairman approved his application
 - "PTT" mode, press microphone On/Off button to talk
- Automatic video tracking implementation when cooperating with cameras & video switcher unit; preset positions on PC
- Activation at any time (if the amount of active microphones in the system is less than 8)
- Priority button to switch off or to mute the delegate units (except VIP units) according to preset
- Approves/denies delegates' speaking request
- System supports up to 100 chairman units, while all or part chairman units have the control facilities listed above (set by software or main unit)

Controls and Indicators

- Microphone On/Off button with indicator
- Priority button with indicator
- Apply button with indicator

Interconnections

- XLR connector for condenser microphone with +36 V phantom power
- Ø 3.5 mm stereo headphone jack
- 1.5 m cable with 8P-DIN plug
- 0.6 m cable with 8P-DIN socket

Technical Specifications

Electrical

Max. consumption.....2.1 W

Headphone connection

Frequency response.....20 Hz to 20 kHz

Earphone load impedance.....>16 Ohm

Earphone output.....10 mW

Interface data

Connector.....Ø 3.5 mm stereo jack for headphone

Mechanical

Mounting.....Tabletop

Dimensions (h x w x d).....41 x 115 x 123 mm(base)

Weight.....0.7 kg

Color.....Black (PANTONE 419 C)

Ordering Information

HCS-4860CXD_B/80...Fully Digital Congress System Chairman Unit (tabletop, discussion, XLR connector for condenser microphone with +48V phantom power, black, without microphone, HCS-1857/HCS-1858 is needed)

HCS-4860DXD_B/80 Delegate Unit



Features

- **Elegant and ergonomic design**
- **XLR connector for condenser microphone with +48 V phantom power**
- **Apply button**
- **“Closed Loop - Daisy Chain” connection topology**
- **Supporting 48 kHz audio sampling rate**
- **Excellent immunity to RF interference from mobile phones**
- **Separate adjustment of gain and EQ (5 band) of each microphone for the perfect sound**
- **Supporting “PnP” (plug and play)**

The stylish and ergonomically designed chairman unit has all the necessary facilities to enable the user to chair a conference. It has excellent immunity to RF interference from mobile phones.

Functions

- Compliant to ISO 22259
- “Closed Loop - Daisy Chain” connection topology for a high operational system reliability: breakdown or replacement of a congress unit and connection failure of a cable will not influence other congress units
- Based on TAIDEN originated MCA-STREAM digital audio processing and transmitting technologies
- Proprietary MCA-STREAM technology used to transmit fully digital audio between the congress units as well as between congress units and main unit(s)
- Audio signals processed by high performance DSP: sound quality approaching CD quality
- Gain and EQ (5 band) of each microphone adjustable separately, fitting the individual orator’s voice to achieve perfect speech pickup any time
- Supporting 48 kHz audio sampling rate
- Integrated high-pass filter (low-cut switch) to cut low frequency elements from the audio when needed
- Automatic system recovery and “PnP” (plug and play)
- XLR connector for condenser microphone with +48 V phantom power
- Excellent immunity to RF interference from mobile phones and comparable devices
- Microphone On/Off button
- An ID can be assigned by default or manually to each conference unit bearing a unique serial number for convenient maintenance
- Facilities in independent operation from computer:

- ◆ Set the number of delegates permitted to speak at the same time
- ◆ Speak mode: Open/Override/Voice/Request/PTT
 - “Open” mode, microphone On/Off button with request-to-speak registration (AUTO)
 - “Override” mode, microphone On/Off button control with override of the active microphones (FIFO)
 - “Voice” mode, acoustic active sensitivity and automatic switch-off time adjustable continuously, built-in “flash-on” technology, immediate microphone activation on speaking
 - “Request” mode, delegate requests to speak by pressing microphone On/Off button, delegate only speaks when operator or chairman approved his application
 - “PTT” mode, press microphone On/Off button to talk
- Automatic video tracking implementation when cooperating with cameras & video switcher unit; preset positions on PC
- Activation at any time (if the amount of active microphones in the system is less than 8)
- Set any delegate unit to be VIP unit
 - ◆ Up to 32 units can be set as VIP in one system via application software
 - ◆ VIP unit can be activated as long as the total of active microphones is not beyond 8 (incl. chairman/delegate/VIP unit)

Controls and Indicators

- Microphone On/Off button with indicator
- Apply button with indicator

Interconnections

- XLR connector for condenser microphone with +48 V phantom power
- Ø 3.5 mm stereo headphone jack
- 1.5 m cable with 8P-DIN plug
- 0.6 m cable with 8P-DIN socket

Technical Specifications

Electrical

Max. consumption.....2.1 W

Headphone connection

Frequency response.....20 Hz to 20 kHz

Earphone load impedance.....>16 Ohm

Earphone output.....10 mW

Interface data

Connector.....Ø 3.5 mm stereo jack for headphone

Mechanical

Mounting.....Tabletop

Dimensions (h x w x d).....41 x 115 x 123 mm(base)

Weight.....0.7 kg

Color.....Black (PANTONE 419 C)

Ordering Information

HCS-4860DXD_B/80..... Fully Digital Congress System Chairman Unit (tabletop, discussion, XLR connector for condenser microphone with +48V phantom power, black, without microphone, HCS-1857/HCS-1858is needed)

Function List

Model No.	Type	Speech	Digital audio + analog audio dual system backup	Main Unit	Cable
HCS-4860CXD/80	Chairman	√	√	HCS-4800MA/20 HCS-4800MB/20	8-pin dedicated cable
HCS-4860DXD/80	Delegate	√	√	HCS-4800MC	

HCS-4813C Chairman Unit with Voting and Channel Selection



Features

- Stylish and ergonomic design
- Exquisite and delicate tabletop design for ease of use and transport
- Cable coming out of the base for a tidier wiring
- Invisible microphone
- Priority button
- Microphone On/Off button
- 5 voting keys
- Braille is present for physical buttons
- OLED screen with high brightness and contrast, wide viewing angle and low power consumption
- “Closed Loop - Daisy Chain” connection topology
- Transmitting up to 64 CHs high quality digital audio signals on a dedicated 8-pin cable
- Built-in channel selector consists of channel select keys and channel indicator display
- Excellent immunity to RF interferences from mobile phones
- Separate adjustment of gain and EQ (5 band) of each microphone for the perfect sound
- Supporting “PnP” (plug and play)

The stylish and ergonomically designed chairman unit has all the necessary facilities to enable the user to chair a conference. It has excellent immunity to RF interferences from mobile phones. Similar in appearance to HCS-4813D Delegate Unit, the HCS-4813C Chairman Unit includes a microphone priority button. When pressed, the priority button causes all currently active delegate microphones to be switched off temporarily or permanently, allowing the chairman to take control of the meeting. Channel selection is automatically limited to the number of language channels available.

Functions

- Compliant to ISO 22259
- “Closed Loop - Daisy Chain” connection topology for a high operational system reliability: breakdown or replacement of a Congress Unit and connection failure of a cable will not influence other Congress Units
- Based on TAIDEN originated MCA-STREAM digital audio processing and transmitting technology

- Proprietary MCA-STREAM technology used to transmit fully digital audio between the congress units as well as between congress units and main unit(s)
- Audio signals processed by high performance DSP: sound quality approaching CD quality
- Invisible microphone
- Gain and EQ (5 band) of each microphone adjustable separately, fitting the individual orator’s voice to achieve perfect speech pickup any time
- Integrated high-pass filter (low-cut switch) to cut low frequency elements from the audio when needed
- Built-in adaptive feedback suppression (AFC) and adaptive noise control (ANC) functions to improve the system’s audio gain, and always maintain a clear and stable pickup effect
- Transmitting up to 64 CHs high quality digital audio signals on a dedicated 8-pin cable (general cat5e cable with a drain wire substitutable)
- Supports up to 64 (1+63) CHs simultaneous interpretation
- Supports 48 kHz audio sampling, and all 64 channels perfectly reproducing audio frequencies between 20 Hz and 20 kHz
- Automatic recovery facility, supporting “PnP” (plug and play)
- Excellent immunity to RF interferences from mobile phones and comparable devices
- Priority button, Microphone On/Off button
- 5 voting keys, Key-press sign-in
- Braille is present for all physical buttons
- An ID can be assigned by default or manually to each conference unit bearing a unique serial number for convenient maintenance
- Facilities in independent operation from computer:
 - ◆ Set the number of delegates permitted to speak at the same time
 - ◆ Speak mode: Open/Override/Voice/Request/PTT
 - “Open” mode, microphone On/Off button with request-to-speak registration (AUTO)
 - “Override” mode, microphone On/Off button control with override of the active microphones (FIFO)
 - “Voice” mode, acoustic active sensitivity and automatic switch-off time adjustable continuously, built-in “flash-on” technology, immediate microphone activation on speaking
 - “Request” mode, delegate requests to speak by pressing microphone On/Off button, delegate only speaks when operator or chairman approved his application
 - “PTT” mode, press microphone On/Off button to talk
 - ◆ Simultaneous interpretation
- Multiform voting in combination with the corresponding software modules
- Automatic video tracking implementation when cooperating with cameras and video switcher unit; preset positions on PC
- Activation at any time (if the amount of active microphones in the system is less than 8)
- Priority button to switch off or to mute the delegate units (except VIP units) according to preset
- Approves/denies delegates’ speaking request
- System supports up to 100 chairman units, while all or part chairman units have the control facilities listed above (set by software or main unit)

Controls and Indicators

- Graphic 128x36 OLED for displaying Channel number and language name
- Built-in channel selector with channel select buttons
- Uni-directional electret condenser microphone
- Five voting buttons with indicators
- Headphones volume up and down
- Microphone On/Off button with indicator
- Priority button with indicator

Interconnections

- Ø 3.5 mm stereo headphone jack with volume control
- 1.5 m cable with 8P-DIN plug
- 0.6 m cable with 8P-DIN socket

Technical Specifications

Electrical

Max. consumption..... 1.8 W

Headphone connection

Frequency response.....20 Hz to 20 kHz

Earphone load impedance.....≥16 Ohm

Earphone output power.....10 mW

Microphone

Transducer.....Electret-condenser

Polar pattern.....Uni-directional

Sensitivity.....-46 dBV/Pa

Frequency response.....50 Hz to 20 kHz

Input impedance.....2 kOhm

Directivity 0°/180°.....> 20 dB (1 kHz)

Equivalent noise.....20 dBA (SPL)

Maximum sound pressure level.....125 dB (THD<3%)

Interface data

Connector.....Ø 3.5 mm stereo jack for headphone

Mechanical

Mounting.....Tabletop

Dimensions (h × w × d).....52 × 201 × 119 mm

Weight.....0.5 kg

Color.....Black (PANTONE 419 C)

Ordering Information

HCS-4813C.....Fully Digital Congress System Chairman Unit
(tabletop, invisible microphone, 5 voting keys,
64 CHs, black)

HCS-4813D Delegate Unit with Voting and Channel Selection



Features

- Stylish and ergonomic design
- Exquisite and delicate tabletop design for ease of use and transport
- Cable coming out of the base for a tidier wiring
- Invisible microphone
- Microphone On/Off button
- 5 voting keys
- Braille is present for physical buttons
- OLED screen with high brightness and contrast, wide viewing angle and low power consumption
- “Closed Loop - Daisy Chain” connection topology
- Transmitting up to 64 CHs high quality digital audio signals on a dedicated 8-pin cable
- Built-in channel selector consists of channel select keys and channel indicator display
- Excellent immunity to RF interferences from mobile phones
- Separate adjustment of gain and EQ (5 band) of each microphone for the perfect sound
- Supporting “PnP” (plug and play)

The multi-functional delegate unit meets the demands of even the largest conferences. It provides facilities for speaking, listening, voting and selecting language channels and offers excellent immunity to RF interferences from mobile phones. It features a channel selector with automatic limitation to the number of language channels available.

Functions

- Compliant to ISO 22259
- “Closed Loop - Daisy Chain” connection topology for a high operational system reliability: breakdown or replacement of a Congress Unit and connection failure of a cable will not influence other Congress Units
- Based on TAIDEN originated MCA-STREAM digital audio processing and transmitting technology
- Proprietary MCA-STREAM technology used to transmit fully digital audio between the congress units as well as between congress units and main unit(s)
- Audio signals processed by high performance DSP: sound quality approaching CD quality
- Invisible microphone

- Gain and EQ (5 band) of each microphone adjustable separately, fitting the individual orator's voice to achieve perfect speech pickup any time
- Integrated high-pass filter (low-cut switch) to cut low frequency elements from the audio when needed
- Built-in adaptive feedback suppression (AFC) and adaptive noise control (ANC) functions to improve the system's audio gain, and always maintain a clear and stable pickup effect
- Transmitting up to 64 CHs high quality digital audio signals on a dedicated 8-pin cable (general cat5e cable with a drain wire substitutable)
- Supports up to 64 (1+63) CHs simultaneous interpretation
- Supports 48 kHz audio sampling, and all 64 channels perfectly reproducing audio frequencies between 20 Hz and 20 kHz
- Automatic recovery facility, supporting “PnP” (plug and play)
- Excellent immunity to RF interferences from mobile phones and comparable devices
- Microphone On/Off button
- 5 voting keys, Key-press sign-in
- Braille is present for all physical buttons
- An ID can be assigned by default or manually to each conference unit bearing a unique serial number for convenient maintenance
- Facilities in independent operation from computer:
 - ◆ Set the number of delegates permitted to speak at the same time
 - ◆ Speak mode: Open/Override/Voice/Request/PTT
 - “Open” mode, microphone On/Off button with request-to-speak registration (AUTO)
 - “Override” mode, microphone On/Off button control with override of the active microphones (FIFO)
 - “Voice” mode, acoustic active sensitivity and automatic switch-off time adjustable continuously, built-in “flash-on” technology, immediate microphone activation on speaking
 - “Request” mode, delegate requests to speak by pressing microphone On/Off button, delegate only speaks when operator or chairman approved his application
 - “PTT” mode, press microphone On/Off button to talk
 - ◆ Simultaneous interpretation
- Multiform voting in combination with the corresponding software modules
- Automatic video tracking implementation when cooperating with cameras and video switcher unit; preset positions on PC
- Set any delegate unit to be VIP unit
 - ◆ Up to 32 units can be set as VIP in one system via application software
 - ◆ VIP unit can be activated as long as the total of active microphones is not beyond 8 (incl. chairman/delegate/VIP unit)

Controls and Indicators

- Graphic 128x36 OLED for displaying Channel number and language name
- Built-in channel selector with channel select buttons
- Uni-directional electret condenser microphone

- Five voting buttons with indicators
- Headphones volume up and down
- Microphone On/Off button with indicator

Interconnections

- Ø 3.5 mm stereo headphone jack with volume control
- 1.5 m cable with 8P-DIN plug
- 0.6 m cable with 8P-DIN socket

Technical Specifications

Electrical

Max. consumption..... 1.8 W

Headphone connection

Frequency response.....20 Hz to 20 kHz

Earphone load impedance.....≥16 Ohm

Earphone output power..... 10 mW

Microphone

Transducer.....Electret-condenser

Polar pattern.....Uni-directional
 Sensitivity.....-46 dBV/Pa
 Frequency response..... 50 Hz to 20 kHz
 Input impedance.....2 kOhm
 Directivity 0°/180°.....> 20 dB (1 kHz)
 Equivalent noise.....20 dBA (SPL)
 Maximum sound pressure level.....125dB (THD<3%)

Interface data

Connector.....Ø 3.5 mm stereo jack for headphone

Mechanical

Mounting.....Tabletop

Dimensions (h × w × d).....52 × 201 × 119 mm

Weight.....0.7kg

Color.....Black (PANTONE 419 C)

Ordering Information

HCS-4813D..... Fully Digital Congress System Delegate Unit
 (tabletop, invisible microphone, 5 voting keys,
 64 CHs, black)

HCS-4815C Chairman Unit



Features

- Stylish and ergonomic design
- Exquisite and delicate tabletop design for ease of use and transport
- Cable coming out of the base for a tidier wiring
- Invisible microphone
- Priority button
- Microphone On/Off button
- Braille is present for physical buttons
- “Closed Loop - Daisy Chain” connection topology
- Supporting 48 kHz audio sampling rate
- Excellent immunity to RF interferences from mobile phones
- Separate adjustment of gain and EQ (5 band) of each microphone for the perfect sound
- Supporting “PnP” (plug and play)

The stylish and ergonomically designed chairman unit has all the necessary facilities to enable the user to chair a conference. It has excellent immunity to RF interferences from mobile phones. Similar in appearance to HCS-4815D Delegate Unit, the HCS-4815C Chairman Unit includes a microphone priority button. When pressed, the priority button causes all currently active delegate microphones to be switched off temporarily or permanently, allowing the chairman to take control of the meeting.

Functions

- Compliant to ISO 22259
- “Closed Loop - Daisy Chain” connection topology for a high operational system reliability: breakdown or replacement of a Congress Unit and connection failure of a cable will not influence other Congress Units
- Based on TAIDEN originated MCA-STREAM digital audio processing and transmitting technology
- Proprietary MCA-STREAM technology used to transmit fully digital audio between the congress units as well as between congress units and main unit(s)
- Audio signals processed by high performance DSP: sound quality approaching CD quality
- Invisible microphone
- Gain and EQ (5 band) of each microphone adjustable separately, fitting the individual orator’s voice to achieve perfect speech pickup any time
- Integrated high-pass filter (low-cut switch) to cut low frequency elements from the audio when needed

- Built-in adaptive feedback suppression (AFC) and adaptive noise control (ANC) functions to improve the system’s audio gain, and always maintain a clear and stable pickup effect
- Supports 48 kHz audio sampling
- Automatic recovery facility, supporting “PnP” (plug and play)
- Excellent immunity to RF interferences from mobile phones and comparable devices
- Priority button, Microphone On/Off button
- Braille is present for all physical buttons
- An ID can be assigned by default or manually to each conference unit bearing a unique serial number for convenient maintenance
- Facilities in independent operation from computer:
 - ◆ Set the number of delegates permitted to speak at the same time
 - ◆ Speak mode: Open/Override/Voice/Request/PTT
 - “Open” mode, microphone On/Off button with request-to-speak registration (AUTO)
 - “Override” mode, microphone On/Off button control with override of the active microphones (FIFO)
 - “Voice” mode, acoustic active sensitivity and automatic switch-off time adjustable continuously, built-in “flash-on” technology, immediate microphone activation on speaking
 - “Request” mode, delegate requests to speak by pressing microphone On/Off button, delegate only speaks when operator or chairman approved his application
 - “PTT” mode, press microphone On/Off button to talk
- Automatic video tracking implementation when cooperating with cameras and video switcher unit; preset positions on PC
- Low power consumption design
- Activation at any time (if the amount of active microphones in the system is less than 8)
- Priority button to switch off or to mute the delegate units (except VIP units) according to preset
- Approves/denies delegates’ speaking request
- System supports up to 100 chairman units, while all or part chairman units have the control facilities listed above (set by software or main unit)

Controls and Indicators

- Uni-directional electret condenser microphone
- Microphone On/Off button with indicator
- Priority button with indicator

Interconnections

- Ø 3.5 mm stereo headphone jack
- 1.5 m cable with 8P-DIN plug
- 0.6 m cable with 8P-DIN socket

Technical Specifications

Electrical

Max. consumption..... 1.8 W

Headphone connection

Frequency response.....20 Hz to 20 kHz
 Earphone load impedance.....≥16 Ohm
 Earphone output power.....10 mW

Microphone

Transducer.....Electret-condenser
 Polar pattern.....Uni-directional
 Sensitivity.....-46 dBV/Pa
 Frequency response.....50 Hz to 20 kHz
 Input impedance.....2 kOhm
 Directivity 0°/180°.....> 20 dB (1 kHz)
 Equivalent noise.....20 dBA (SPL)
 Maximum sound pressure level.....125 dB (THD<3%)

Interface data

Connector.....Ø 3.5 mm stereo jack for headphone

Mechanical

Mounting.....Tabletop
 Dimensions (h × w × d).....52 × 201 × 119 mm
 Weight.....0.7kg
 Color.....Black (PANTONE 419 C)

Ordering Information

HCS-4815C.....Fully Digital Congress System Chairman Unit
 (tabletop, invisible microphone, black)

HCS-4815D Delegate Unit



Features

- Stylish and ergonomic design
- Exquisite and delicate tabletop design for ease of use and transport
- Cable coming out of the base for a tidier wiring
- Invisible microphone
- Microphone On/Off button
- Braille is present for physical buttons
- “Closed Loop - Daisy Chain” connection topology
- Supporting 48 kHz audio sampling rate
- Excellent immunity to RF interferences from mobile phones
- Separate adjustment of gain and EQ (5 band) of each microphone for the perfect sound
- Supporting “PnP” (plug and play)

The delegate unit meets the basic demands of conferences. It provides facilities for speaking and listening and offers excellent immunity to RF interferences from mobile phones.

Functions

- Compliant to ISO 22259
- “Closed Loop - Daisy Chain” connection topology for a high operational system reliability: breakdown or replacement of a Congress Unit and connection failure of a cable will not influence other Congress Units
- Based on TAIDEN originated MCA-STREAM digital audio processing and transmitting technology
- Proprietary MCA-STREAM technology used to transmit fully digital audio between the congress units as well as between congress units and main unit(s)
- Audio signals processed by high performance DSP: sound quality approaching CD quality
- Invisible microphone
- Gain and EQ (5 band) of each microphone adjustable separately, fitting the individual orator’s voice to achieve perfect speech pickup any time
- Integrated high-pass filter (low-cut switch) to cut low frequency elements from the audio when needed
- Built-in adaptive feedback suppression (AFC) and adaptive noise control (ANC) functions to improve the system’s audio gain, and always maintain a clear and stable pickup effect
- Supports 48 kHz audio sampling
- Automatic recovery facility, supporting “PnP” (plug and play)
- Excellent immunity to RF interferences from mobile phones and comparable devices

- Microphone On/Off button
- Braille is present for all physical buttons
- An ID can be assigned by default or manually to each conference unit bearing a unique serial number for convenient maintenance
- Facilities in independent operation from computer:
 - ◆ Set the number of delegates permitted to speak at the same time
 - ◆ Speak mode: Open/Override/Voice/Request/PTT
 - “Open” mode, microphone On/Off button with request-to-speak registration (AUTO)
 - “Override” mode, microphone On/Off button control with override of the active microphones (FIFO)
 - “Voice” mode, acoustic active sensitivity and automatic switch-off time adjustable continuously, built-in “flash-on” technology, immediate microphone activation on speaking
 - “Request” mode, delegate requests to speak by pressing microphone On/Off button, delegate only speaks when operator or chairman approved his application
 - “PTT” mode, press microphone On/Off button to talk
- Automatic video tracking implementation when cooperating with cameras and video switcher unit; preset positions on PC
- Low power consumption design
- Set any delegate unit to be VIP unit
 - ◆ Up to 32 units can be set as VIP in one system via application software
 - ◆ VIP unit can be activated as long as the total of active microphones is not beyond 8 (incl. chairman/delegate/VIP unit)

Controls and Indicators

- Uni-directional electret condenser microphone
- Microphone On/Off button with indicator

Interconnections

- Ø 3.5 mm stereo headphone jack
- 1.5 m cable with 8P-DIN plug
- 0.6 m cable with 8P-DIN socket

Technical Specifications

Electrical

Max. consumption..... 1.8 W

Headphone connection

Frequency response.....20 Hz to 20 kHz

Earphone load impedance.....≥16 Ohm

Earphone output power.....10 mW

Microphone

Transducer..... Electret-condenser

Polar pattern..... Uni-directional

Sensitivity.....-46 dBV/Pa

Frequency response..... 50 Hz to 20 kHz

Input impedance.....2 kOhm

Directivity 0°/180° > 20 dB (1 kHz)
Equivalent noise 20 dBA (SPL)
Maximum sound pressure level 125dB (THD<3%)

Interface data

Connector Ø 3.5 mm stereo jack for headphone

Mechanical

Mounting Tabletop
Dimensions (h × w × d) 52 × 201 × 119 mm
Weight 0.7kg
Color Black (PANTONE 419 C)

Ordering Information

HCS-4815D Fully Digital Congress System Delegate Unit
(tabletop, invisible microphone, black)

HCS-4840DHT Multi-function Connector



Functions

- Connection with HCS-4842DHT channel selector
- “Closed Loop - Daisy Chain” connection topology
- Data transmission between the units by patented “MCA-STREAM” technology
- Proprietary MCA-STREAM technology used to transmit fully digital audio between the congress units as well as between congress units and main unit(s)
- Automatic system recovery and “PnP” (plug and play)

Interconnections

- Built-in 4 x RJ45 interface:
 - ◆ HCS-4840DHT can connect 4 pcs HCS-4842DHT channel selectors
- 2 m cable with 8P-DIN plug for connection to system CMU or to another Multi-function Connector
- 8P-DIN standard socket for loop-through interconnection

Technical Specifications

Electrical

Max. consumption.....2.1W

Mechanical

Mounting	Fixed mounting
Dimensions (h x w x d)	32 x 86 x 176 mm
Weight	0.9 kg
Color	Silver (PANTONE 401 C)

Ordering Information

HCS-4840DHT.....Multi-function Connector (for connection to 4 pcs of HCS-4842DHT channel selectors, silver)

HCS-4841DMIC Multi-function Connector



Functions

- “Closed Loop - Daisy Chain” connection topology
- Data transmission between the units by patented “MCA-STREAM” technology
- Proprietary MCA-STREAM technology used to transmit fully digital audio between the congress units as well as between congress units and main unit(s)
- Automatic system recovery and “PnP” (plug and play)
- Connect 2 microphones through phoenix interface, 48V phantom power
- Microphone switch and indicator

Interconnections

- Built-in 2 x RJ45 interface
- Recommended use of cat5e cable with a drain wire & RJ45 plug with metal shield, via the CBL8P2RJ45S converter cable connect to the EMU

Mechanical

Frequency response.....	20 Hz to 20 kHz
Maximum power consumption.....	2.1W
Output power	10 mW
Color.....	Black(PANTONE 419C)
Dimensions(h x w x d).....	40 x 81x 120
Weight.....	0.4 kg

Ordering Information

HCS-4841DMIC.....Multi-function Connector(for connection to 2 microphones, +48 V phantom power, black)

HCS-4842DHT Flush-mounting 64-Channel Selector



Features

- Ergonomically compact and elegant design
- 64 language channels for simultaneous interpretation, all channels with a 20 Hz to 20 kHz frequency response
- Faster processing speed and better audio quality with fully digital audio technology and built-in high-performance CPU
- Built-in “Silent” function
- Automatically adapts to available channels
- No audio output until the headphone is connected
- Flush mountable in tabletops, on top or at the front, or in arm rests of seats

The HCS-4842DHT is a compact and stylish single-user audio channel selector for listening by headphone. It provides a choice of up to 64 high-quality audio channels used for distribution of interpretation and floor channels.

Functions

- 64 language channels for simultaneous interpretation, all channels with a 20 Hz to 20 kHz frequency response
- Built-in channel selector (w/ up/down key) and OLED display
- The channel selector is active only when the headphone is inserted
- Built-in “Silent” function, to eliminate audible noise from the headphone. When not in use there is no audio output until one of the keys has been pressed
- Upon insertion of a headphone the default “floor” channel (channel 0) is selected with a comfortable headphone volume and the dimmed backlighting is activated

Controls and Indicators

- Two push-buttons (up/down) for channel selection
- Two push-buttons (up/down) for headphone volume control
- Backlight OLED with screen saver for channel number indication interconnection

Interconnections

- Ø 3.5 mm jack for headphone
- RJ45 standard interface: connect with HCS-4840DHT Multi-function Connector via Cat.5 cable

Ordering Information

HCS-4842DHT.....64-Channel Selector (flush-mounting,
HCS-4840DHT needed, black

HCS-4842X4 64-Channel × 4 Portable Audio Distributor



Functions

- For audio distribution to the media
- Faster processing speed and better audio quality with fully digital audio technology and built-in high-performance CPU
- Up to 64 language channels available
- Four-channel output with independent channel selector and volume control
- OLED display of the live channel number, name and volume

Interconnections

- 4 XLR connectors for audio output
- 2.1 m cable with 8P-DIN plug
- 8P-DIN socket

Technical Specifications

Electrical

Frequency response.....100 Hz - 20 kHz
 S/N.....≥78 dBA
 Audio output.....4×XLR Balanced output
Max. 0 dBV
 THD.....≤0.5%
 Power supply.....DC 48 V, 75 mA

Mechanical

Dimensions.....226×141×42 mm
 Mounting.....Flush-mounting or wall-mounting
 Weight.....1.0 kg

Ordering Information

HCS-4842X4.....64-Channel×4 Portable Audio Distributor

HCS-4852T 8-pin Cable Splitter

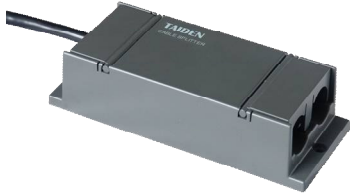

Features

- Relay facility, amplification of the communication signals
- 8P-DIN interfaces, "1 in / 3 out " structure for connection
- 2m-cable with a 8P-DIN connector at the input end
- Three 8PIN output interfaces, can drive 60-meter long extension cable
- Dimensions (h × w × d): 35 × 149 × 90 mm

Ordering Information

HCS-4852T.....8-pin Cable Splitter (1 input & 3 outputs, for HCS-4800 and HCS-8600 series)

HCS-4852TN RJ45 Port Splitter



Features

- Relay facility, amplification of the communication signals
- RJ45 sockets, "1 in / 4 out " structure for connection
- RJ45 socket at the input end
- Four RJ45 output sockets, can drive 60-meter long extension cable
- Dimensions (h × w × d): 24 × 103 × 66 mm
- Weight: 68g

Ordering Information

HCS-4852TN.....RJ45 Port Splitter (1 input & 4 outputs, for HCS-4800 and HCS-8600 series)

HCS-4853T Cable Splitter

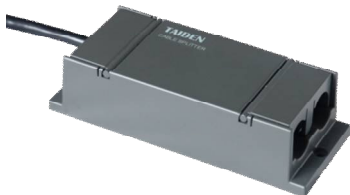

Features

- Relay facility, amplification of the communication signals
- "1 in / 3 out " structure for connection
- For connection between HCS-8685 Interpretation Unit and HCS-8300M series, HCS-4100M/50 series, HCS-5100MA/B series
- 2m-cable with a 6P-DIN connector at the input end
- Three 8PIN output interfaces, can drive 60-meter long extension cable
- Dimensions (h × w × d): 35 × 149 × 90 mm

Ordering Information

HCS-4853T.....6-pin to 8-pin Cable Splitter (1 input (6P-DIN) & 3 outputs (8P-DIN), for connection between HCS-8685 Interpretation Unit and HCS-8300M series, HCS-4100M/50 series, HCS-5100MA/B series)

HCS-4800MA/20 Congress Main Unit



Features

- Connectable to multi-channel audio input or output devices for versatile expansion of the system
- High system reliability guaranteed by “Closed Loop - Daisy Chain” connection topology
- Proprietary MCA-STREAM technology used to transmit fully digital audio between main unit(s) and congress units
- Perfect sound quality on all 64 simultaneous interpretation channels: frequency response 20 Hz to 20 kHz
- Equipped with optical fiber interface to combine two widely separated conference rooms to form one unique coherent system
- Connection facility for an additional condenser or dynamic microphone, expanding user’s application spectrum
- TCP/IP communication protocol in PC control
- Remote control, remote diagnosis and remote update
- Voting facilities without PC intervention
- Built-in multi-channel intercom facility
- Plug and play for all units
- Excellent immunity to RF interferences from mobile phones and comparable devices
- System power controllable by central control system
- 2.8" LCD display for status information and configuration
- Rotary control to navigate through the LCD menus
- With web page control function, main unit’s parameters can be set through web browser
- Emergency signal interface, all congress units will be switched off when it be activated

The Congress Main Unit includes features for controlling delegate microphones, distributing simultaneous interpretation and conducting voting sessions, without an operator.

In combination with a PC, the Congress Main Unit brings greater sophistication to conference control. Users are able to access an extensive range of software, each with a specific function in controlling and monitoring a conference, greatly expanding the capacity to manage a conference. In the event of PC failure, the Congress Main Unit will revert to its stand-alone operation mode, enabling the conference to proceed.

The Congress Main Unit also provides power supply to the Congress units.

Functions

- Compliant to ISO 22259
- “Closed Loop - Daisy Chain” connection topology for a high operational system reliability: breakdown or replacement of a Congress Unit and connection failure of a cable will not influence other Congress Units
- Embedded high performance DSP for audio signal processing, supporting 48 kHz audio sampling rate. All 64 channels feature perfect sound quality with a frequency response of 20 Hz to 20 kHz
- Gain and EQ (5 band) of each microphone adjustable separately, fitting the individual orator’s voice to achieve perfect speech pickup any time
- Integrated high-pass filter (low-cut switch) to cut low frequency elements from the audio when needed
- Integrated voice enhance and howling suppression function for each microphone to improve sound effects
- 2 audio line in or 1 audio line in + 1 microphone input: gain and EQ for each input adjustable separately, +48 V phantom power available at microphone input, a condenser microphone can be connected directly
- Unit offers connection facilities to multi-channel audio input or output devices for versatile expansion of the system
- Based on TAIDEN originated MCA-STREAM digital audio processing and transmitting technology
- Adopted fully digital audio transmitting technology between the main units and congress units
- An ID can be assigned by default or manually to each conference unit bearing a unique serial number for convenient maintenance
- Set any delegate unit to be VIP unit, VIP unit can be activated as long as the total of active microphones is not beyond 8
- Built-in multi-channel intercom facility
- Connection facility for additional condenser or dynamic microphones, expanding user’s application spectrum (HCS-8600MIO series)
- If additional contribution units are connected for system expansion, additional Congress Extension Main Units HCS-8600MEA are required:
 - ◆ 4096 discussion or voting units
 - ◆ 378 interpreter units (with maximum 63 booths, each booth with maximum 6 interpreter units)
 - ◆ Any quantity of channel selectors
- With the Audio Input & Output Device (several units cascable), multi-channel digital/analog audio signals are available as output signals for infrared language distribution system or recording
- Automatic video tracking implementation when cooperating with cameras and video switcher unit; preset positions on PC
- Implemented features in stand-alone mode:
 - ◆ Set the number (1~8) of delegates permitted to speak at the same time
 - ◆ Set-up of speaking time limitation (1~240 minutes)
 - ◆ Speak mode: Open/Override/Voice/Request/PTT
 - "Open" mode, microphone On/Off button with request-to-speak registration (AUTO)
 - "Override" mode, microphone On/Off button control with override of the active microphones (FIFO)

- "Voice" mode, acoustic active sensitivity and automatic switch-off time adjustable continuously, built-in "flash-on" technology, immediate microphone activation on speaking
- "Request" mode, delegate requests to speak by pressing microphone On/Off button, delegate only speaks when operator or chairman approved his application
- "PTT" mode, press microphone On/Off button to talk
- ◆ Parliamentary voting (YES/NO/ABSTAIN)
- ◆ 64 (1+63) channels simultaneous interpretation function. Cooperates with channel selector or infrared language distribution system enabling a larger audience to follow the conference
- In combination with the corresponding software, more functions can be implemented:
 - ◆ Centralized microphone management
 - ◆ Multiform voting:
 - For/Against
 - Parliamentary: YES/NO/ABSTAIN
 - Questionnaire: 1/2/3/4/5
 - Audience response: --/-/0/+/++
 - Parliamentary (NPPV): Yes/No/ABSTAIN/NPPV
 - Appraisal:
 - ◇ Satisfied (four keys voting: perfectly satisfied/satisfied/basically satisfied/unsatisfied) (three keys voting: satisfied/basically satisfied/unsatisfied) (two keys voting: satisfied/unsatisfied)
 - ◇ Qualified (four/three/two keys voting)
 - ◇ Competent (four/three/two keys voting)
 - ◆ Several sign-in modes: entrance sign-in/seat sign-in
 - ◆ Depending on the purchased HCS-4800 software, user gains access to additional conference control & management functions
- Advanced TCP/IP communication protocol in PC controlled mode, easy to carry out remote control, remote diagnosis and remote update
- With web page control function, main unit's parameters can be set through web browser
- USB interface (Type-c) support digital audio transmission, mainstream conference software is adaptive
- Hot spare dual server structure: another Congress Main Unit is set up as backup Congress Main Unit and connected to the system and takes over automatically if the main Congress Main Unit fails
- Multi-room configuration: Congress Main Unit(s) can be used as Congress Extension Main Unit(s) to carry out multi-room configuration flexibly. Multiple Congress Main Unit configuration allows all connected multiple rooms to be operated either as one unique system or as independent systems
- Integrated real-time clock displays time on the LCD of the interpreter unit to inform interpreter to stay on schedule
- Built-in unit detection facilities: detect the unit's microphone, speaker, LEDs and voting keys prior to start the meeting
- Automatic recovery facility, supporting "PnP" (plug and play)
- If the PC is broken down, Congress Main Unit enters the stand-alone state automatically, carrying out basic conference control, ensuring the consistency of the conference
- System power controllable by central control system

Controls and Indicators

- 2.8" LCD displays status and menu of the system configuration, supporting multi-language menu
- Rotary control to navigate through the LCD menus
- Power switch
- Standby switch with indicator

Interconnections

- Multiple audio in/out interfaces:
 - ◆ One balanced XLR-F for microphone input or audio LINE IN
 - ◆ Two symmetrical RCA input interfaces for audio LINE IN
 - ◆ One balanced XLR-M for audio LINE OUT
 - ◆ Two symmetrical RCA output interfaces for audio LINE OUT
- RS232 port for connection to central control system and system diagnosis each
- Duplex SC single-mode optical fiber interface to combine two widely separated conference rooms and to operate as one unique coherent system
- 1 × RJ45 standard socket for connection to Ethernet interface (LAN)
- 2 × RJ45 standard socket (output) for connection with a Congress Extension Main Unit (EXTENSION)
- 2 × outlet (8P-DIN) trunk-line cable outlet
- Emergency signal interface: for connection to public emergency system. Pauses the conference automatically if the system is switched on and sends alarm signals to Congress Units

Technical Specifications

Electrical

Frequency response.....	20 Hz to 20 kHz
SNR.....	≥100 dBA
Dynamic range.....	≥94 dB
Isolation.....	≥90 dB
THD.....	≤0.05%
Power supply.....	100 V - 240 V AC, 50/60 Hz
Consumption.....	20W
Load capacity.....	200W
RS232 connection.....	9-pole Sub-D female socket
Net connection.....	RJ45 socket

Max. audio inputs

LINE IN 1.....	+10 dBu, BAL.
LINE IN 2.....	+10 dBu, UNBAL.

Max. audio outputs

LINE OUT 1.....	+20 dBu, BAL.
LINE OUT 2.....	+20 dBu, UNBAL.

Mechanical

Mounting.....	Tabletop or mounted in a 19" rack
Dimensions (h × w × d)	
For table use, with feet.....	95 × 480 × 418 mm
For 19" rack use, with brackets.....	88 × 480 × 418 mm
Weight.....	7.8 kg
Color.....	Black (PANTONE 419 C)

Ordering Information

HCS-4800MA/20.....Fully Digital Congress System Main
Unit (discussion, voting, 64 CHs, single-mode optical fiber
interface)

HCS-4800MB/20 Congress Main Unit



Features

- Connectable to multi-channel audio input or output devices for versatile expansion of the system
- High system reliability guaranteed by “Closed Loop - Daisy Chain” connection topology
- Proprietary MCA-STREAM technology used to transmit fully digital audio between main unit(s) and congress units
- Supporting 48 kHz and 32 kHz audio sampling rate
- Built-in digital audio power amplifier for connecting loudspeaker
- Connection facility for an additional condenser or dynamic microphone, expanding user’s application spectrum
- TCP/IP communication protocol in PC control
- Remote control, remote diagnosis and remote update
- Voting facilities without PC intervention
- Built-in multi-channel intercom facility
- Plug and play for all units
- Excellent immunity to RF interferences from mobile phones and comparable devices
- System power controllable by central control system
- 2.8” LCD display for status information and configuration
- Rotary control to navigate through the LCD menus
- With web page control function, main unit’s parameters can be set through web browser
- Emergency signal interface, all congress units will be switched off when it be activated

The Congress Main Unit includes features for controlling delegate microphones and conducting voting sessions, without an operator. In combination with a PC, the Congress Main Unit brings greater sophistication to conference control. Users are able to access an extensive range of software, each with a specific function in controlling and monitoring a conference, greatly expanding the capacity to manage a conference. In the event of PC failure, the Congress Main Unit will revert to its stand-alone operation mode, enabling the conference to proceed.

The Congress Main Unit also provides power supply to the Congress units.

Functions

- Compliant to ISO 22259
- “Closed Loop - Daisy Chain” connection topology for a high operational system reliability: breakdown or replacement of a Congress Unit and connection failure of a cable will not influence other Congress Units
- Embedded high performance DSP for audio signal processing, supporting 48 kHz audio sampling rate
- Gain and EQ (5 band) of each microphone adjustable separately, fitting the individual orator’s voice to achieve perfect speech pickup any time
- Integrated high-pass filter (low-cut switch) to cut low frequency elements from the audio when needed
- Integrated voice enhance and howling suppression function for each microphone to improve sound effects
- 2 audio line in or 1 audio line in + 1 microphone input: gain and EQ for each input adjustable separately, +24 V phantom power available at microphone input, a condenser microphone can be connected directly
- Built-in digital audio power amplifier for connecting loudspeaker
- Unit offers connection facilities to multi-channel audio input or output devices for versatile expansion of the system
- Based on TAIDEN originated MCA-STREAM digital audio processing and transmitting technology
- Adopted fully digital audio transmitting technology between the main units and congress units
- An ID can be assigned by default or manually to each conference unit bearing a unique serial number for convenient maintenance
- Set any delegate unit to be VIP unit, VIP unit can be activated as long as the total of active microphones is not beyond 8
- Built-in multi-channel intercom facility
- Connection facility for additional condenser or dynamic microphones, expanding user’s application spectrum (HCS-8600MIO series)
- If additional contribution units are connected for system expansion, additional Congress Extension Main Units HCS-8600MEA are required:
 - ◆ 4096 discussion or voting units
 - ◆ Any quantity of channel selectors
- Automatic video tracking implementation when cooperating with cameras and video switcher unit; preset positions on PC
- Implemented features in stand-alone mode:
 - ◆ Set the number (1~8) of delegates permitted to speak at the same time
 - ◆ Set-up of speaking time limitation (1~240 minutes)
 - ◆ Speak mode: Open/Override/Voice/Request/PTT
 - “Open” mode, microphone On/Off button with request-to-speak registration (AUTO)
 - “Override” mode, microphone On/Off button control with override of the active microphones (FIFO)
 - “Voice” mode, acoustic active sensitivity and automatic switch-off time adjustable continuously, built-in “flash-on” technology, immediate microphone activation on speaking
 - “Request” mode, delegate requests to speak by pressing microphone On/Off button, delegate only speaks when operator or chairman approved his application

- "PTT" mode, press microphone On/Off button to talk
- ◆ Parliamentary voting (YES/NO/ABSTAIN)
- In combination with the corresponding software, more functions can be implemented:
 - ◆ Centralized microphone management
 - ◆ Multiform voting:
 - For/Against
 - Parliamentary: YES/NO/ABSTAIN
 - Questionnaire: 1/2/3/4/5
 - Audience response: --/-/0/+/++
 - Parliamentary (NPPV): Yes/No/ABSTAIN/NPPV
 - Appraisal:
 - ◇ Satisfied (four keys voting: perfectly satisfied/satisfied/basicly satisfied/unsatisfied) (three keys voting: satisfied/basicly satisfied/unsatisfied) (two keys voting: satisfied/unsatisfied)
 - ◇ Qualified (four/three/two keys voting)
 - ◇ Competent (four/three/two keys voting)
 - ◆ Several sign-in modes: entrance sign-in/seat sign-in
 - ◆ Depending on the purchased HCS-4800 software, user gains access to additional conference control & management functions
- Advanced TCP/IP communication protocol in PC controlled mode, easy to carry out remote control, remote diagnosis and remote update
- With web page control function, main unit's parameters can be set through web browser
- USB interface (Type-c) support digital audio transmission, mainstream conference software is adaptive
- Hot spare dual server structure: another Congress Main Unit is set up as backup Congress Main Unit and connected to the system and takes over automatically if the main Congress Main Unit fails
- Multi-room configuration: Congress Main Unit(s) can be used as Congress Extension Main Unit(s) to carry out multi-room configuration flexibly. Multiple Congress Main Unit configuration allows all connected multiple rooms to be operated either as one unique system or as independent systems
- Built-in unit detection facilities: detect the unit's microphone, speaker, LEDs and voting keys prior to start of the meeting
- Automatic recovery facility, supporting "PnP" (plug and play)
- If the PC is broken down, Congress Main Unit enters the stand-alone state automatically, carrying out basic conference control, ensuring the consistency of the conference
- System power controllable by central control system

Controls and Indicators

- 2.8" LCD displays status and menu of the system configuration, supporting multi-language menu
- Rotary control to navigate through the LCD menus
- Power switch
- Standby switch with indicator

Interconnections

- Multiple audio in/out interfaces:
 - ◆ One balanced XLR-F for microphone input or audio LINE IN
 - ◆ Two symmetrical RCA input interfaces for audio LINE IN
 - ◆ One balanced XLR-M for audio LINE OUT

- ◆ Two symmetrical RCA output interfaces for audio LINE OUT
- Output power of PA.....2×160 W (8 Ω)
.....2×200 W (4 Ω)
- RS232 port for connection to central control system and system diagnosis each
- 1 × RJ45 standard socket for connection to Ethernet interface (LAN)
- 2 × RJ45 standard socket (output) for connection with a Congress Extension Main Unit (EXTENSION)
- 2 × outlet (8P-DIN) trunk-line cable outlet
- Emergency signal interface: for connection to public emergency system. Pauses the conference automatically if the system is switched on and sends alarm signals to Congress Units

Technical Specifications

Electrical

Frequency response.....	20 Hz to 20 kHz
SNR.....	≥100 dB
Dynamic range.....	≥94 dB
Isolation.....	≥90 dB
THD.....	≤0.05%
Power supply.....	100 V - 240 V AC, 50/60 Hz
Consumption.....	20W
Load capacity.....	200W
RS232 connection.....	9-pole Sub-D female socket
Net connection.....	RJ45 socket

Max. audio inputs

LINE IN 1.....	+10 dBu, BAL.
LINE IN 2.....	+10 dBu, UNBAL.

Max. audio outputs

LINE OUT 1.....	+20 dBu, BAL.
LINE OUT 2.....	+20 dBu, UNBAL.

Mechanical

Mounting.....	Tabletop or mounted in a 19" rack
Dimensions (h × w × d)	
For table use, with feet.....	95 × 480 × 418 mm
For 19" rack use, with brackets.....	88 × 480 × 418 mm
Weight.....	7.8 kg
Color.....	Black (PANTONE 419 C)

Ordering Information

HCS-4800MB/20.....	Fully Digital Congress System Main Unit (discussion, voting, built-in PA)
--------------------	---

HCS-4800MC Congress Main Unit



Features

- Connectable to multi-channel audio input or output devices for versatile expansion of the system
- High system reliability guaranteed by “Closed Loop - Daisy Chain” connection topology
- Proprietary MCA-STREAM technology used to transmit fully digital audio between main unit(s) and congress units
- Supporting 48 kHz and 32 kHz audio sampling rate
- Connection facility for an additional condenser or dynamic microphone, expanding user’s application spectrum
- TCP/IP communication protocol in PC control
- Remote control, remote diagnosis and remote update
- Voting facilities without PC intervention
- Built-in multi-channel intercom facility
- Plug and play for all units
- Excellent immunity to RF interferences from mobile phones and comparable devices
- System power controllable by central control system
- 2.8” LCD display for status information and configuration
- Rotary control to navigate through the LCD menus
- With web page control function, main unit’s parameters can be set through web browser
- Emergency signal interface, all congress units will be switched off when it be activated

The Congress Main Unit includes features for controlling delegate microphones and conducting voting sessions, without an operator. In combination with a PC, the Congress Main Unit brings greater sophistication to conference control. Users are able to access an extensive range of software, each with a specific function in controlling and monitoring a conference, greatly expanding the capacity to manage a conference. In the event of PC failure, the Congress Main Unit will revert to its stand-alone operation mode, enabling the conference to proceed.

The Congress Main Unit also provides power supply to the Congress units.

Functions

- Compliant to ISO 22259
- “Closed Loop - Daisy Chain” connection topology for a high operational system reliability: breakdown or replacement of a Congress Unit and connection failure of a cable will not influence other Congress Units

- Embedded high performance DSP for audio signal processing, supporting 48 kHz audio sampling rate
- Gain and EQ (5 band) of each microphone adjustable separately, fitting the individual orator’s voice to achieve perfect speech pickup any time
- Integrated high-pass filter (low-cut switch) to cut low frequency elements from the audio when needed
- Integrated voice enhance and howling suppression function for each microphone to improve sound effects
- 2 audio line in or 1 audio line in + 1 microphone input: gain and EQ for each input adjustable separately, +24 V phantom power available at microphone input, a condenser microphone can be connected directly
- Unit offers connection facilities to multi-channel audio input or output devices for versatile expansion of the system
- Based on TAIDEN originated MCA-STREAM digital audio processing and transmitting technology
- Adopted fully digital audio transmitting technology between the main units and congress units
- An ID can be assigned by default or manually to each conference unit bearing a unique serial number for convenient maintenance
- Set any delegate unit to be VIP unit, VIP unit can be activated as long as the total of active microphones is not beyond 8
- Built-in multi-channel intercom facility
- Connection facility for additional condenser or dynamic microphones, expanding user’s application spectrum (HCS-8600MIO series)
- If additional contribution units are connected for system expansion, additional Congress Extension Main Units HCS-8600MEA are required:
 - ◆ 4096 discussion or voting units
 - ◆ Any quantity of channel selectors
- Automatic video tracking implementation when cooperating with cameras and video switcher unit; preset positions on PC
- Implemented features in stand-alone mode:
 - ◆ Set the number (1/2/3/4) of delegates permitted to speak at the same time
 - ◆ Set-up of speaking time limitation (1~240 minutes)
 - ◆ Speak mode: Open/Override/Voice/Request/PTT
 - “Open” mode, microphone On/Off button with request-to-speak registration (AUTO)
 - “Override” mode, microphone On/Off button control with override of the active microphones (FIFO)
 - “Voice” mode, acoustic active sensitivity and automatic switch-off time adjustable continuously, built-in “flash-on” technology, immediate microphone activation on speaking
 - “Request” mode, delegate requests to speak by pressing microphone On/Off button, delegate only speaks when operator or chairman approved his application
 - “PTT” mode, press microphone On/Off button to talk
 - ◆ Parliamentary voting (YES/NO/ABSTAIN)
- In combination with the corresponding software, more functions can be implemented:
 - ◆ Centralized microphone management
 - ◆ Multiform voting:
 - For/Against
 - Parliamentary: YES/NO/ABSTAIN
 - Questionnaire: 1/2/3/4/5
 - Audience response: --/0/+/>++
 - Parliamentary (NPPV): Yes/No/ABSTAIN/NPPV

- Appraisal:
 - ◊ Satisfied (four keys voting: perfectly satisfied/satisfied/basicly satisfied/unsatisfied) (three keys voting: satisfied/basicly satisfied/unsatisfied) (two keys voting: satisfied/unsatisfied)
 - ◊ Qualified (four/three/two keys voting)
 - ◊ Competent (four/three/two keys voting)
- ◆ Several sign-in modes: entrance sign-in/seat sign-in
- ◆ Depending on the purchased HCS-4800 software, user gains access to additional conference control & management functions
- Advanced TCP/IP communication protocol in PC controlled mode, easy to carry out remote control, remote diagnosis and remote update
- With web page control function, main unit's parameters can be set through web browser
- USB interface (Type-c) support digital audio transmission, mainstream conference software is adaptive
- Hot spare dual server structure: another Congress Main Unit is set up as backup Congress Main Unit and connected to the system and takes over automatically if the main Congress Main Unit fails
- Multi-room configuration: Congress Main Unit(s) can be used as Congress Extension Main Unit(s) to carry out multi-room configuration flexibly. Multiple Congress Main Unit configuration allows all connected multiple rooms to be operated either as one unique system or as independent systems
- Built-in unit detection facilities: detect the unit's microphone, speaker, LEDs and voting keys prior to start of the meeting
- Automatic recovery facility, supporting "PnP" (plug and play)
- If the PC is broken down, Congress Main Unit enters the stand-alone state automatically, carrying out basic conference control, ensuring the consistency of the conference
- System power controllable by central control system

Controls and Indicators

- 2.8" LCD displays status and menu of the system configuration, supporting multi-language menu
- Rotary control to navigate through the LCD menus
- Power switch
- Standby switch with indicator

Interconnections

- Multiple audio in/out interfaces:
 - ◆ One balanced XLR-F for microphone input or audio LINE IN
 - ◆ Two symmetrical RCA input interfaces for audio LINE IN
 - ◆ One balanced XLR-M for audio LINE OUT
 - ◆ Two symmetrical RCA output interfaces for audio LINE OUT
- RS232 port for connection to central control system and system diagnosis each
- 1 × RJ45 standard socket for connection to Ethernet interface (LAN)
- 2 × RJ45 standard socket (output) for connection with a Congress Extension Main Unit (EXTENSION)
- 2 × outlet (8P-DIN) trunk-line cable outlet
- Emergency signal interface: for connection to public emergency system. Pauses the conference automatically if the system is switched on and sends alarm signals to Congress Units

Technical Specifications

Electrical

Frequency response.....	20 Hz to 20 kHz
SNR.....	≥100 dBA
Dynamic range.....	≥94 dB
Isolation.....	≥90 dB
THD.....	≤0.05%
Power supply.....	100 V - 240 V AC, 50/60 Hz
Consumption.....	20W
Load capacity.....	200W
RS232 connection.....	9-pole Sub-D female socket
Net connection.....	RJ45 socket

Max. audio inputs

LINE IN 1.....	+10 dBu, BAL.
LINE IN 2.....	+10 dBu, UNBAL.

Max. audio outputs

LINE OUT 1.....	+20 dBu, BAL.
LINE OUT 2.....	+20 dBu, UNBAL.

Mechanical

Mounting.....	Tabletop or mounted in a 19" rack
Dimensions (h × w × d)	
For table use, with feet.....	95 × 480 × 418 mm
For 19" rack use, with brackets.....	88 × 480 × 418 mm
Weight.....	7.8 kg
Color.....	Black (PANTONE 419 C)

Ordering Information

HCS-4800MC.....	Fully Digital Congress System Main Unit (discussion, voting)
-----------------	--

HCS-8600 and HCS-4800 series main unit function table

Type	Discussion	Vote	LCD	64CHs	Microphone team output	Fiber optic interface	Dante interface	AES/EBU digital input/output interface	HDMI interface	USB record	Build-in PA
HCS-8600MA/20	√	√	√	√	√	√	√	√			
HCS-8600MBU/20	√	√	√	√	√	√			√	√	
HCS-8600MB/20	√	√	√	√	√	√					
HCS-4800MA/20	√	√	√	√		√					
HCS-4800MB/20	√	√	√								√
HCS-4800MC	√	√	√								

- In HCS-4800 series fully digital congress system, power is provided by HCS-4800M or HCS-8600MEA or HCS-8600EMS for all congress units. Thus, the total number of system units in any installation is limited by the maximum power handling capacity and control capacity of the HCS-4800M or HCS-8600MEA or HCS-8600EMS. It must be ensured that, during the installation, the sum of the total power consumption of all the congress units connected to every single 8P-DIN interface plus the power loss in the extension cables does not surpass the power limit of each 8P-DIN interface. Otherwise the system will not work properly or automatic protection will occur. Refer to table below for maximum load capability.

Quick lookup table of HCS-4800M CMU and HCS-8600M EMU load capability (each outlet)

Type	Type No.	The extension cable length between the CMU(EMU) and the first Congress Unit connected to the socket			
		20 m	40 m	60 m	80 m
Equipped with 6.8" LCD, speaker and microphone	HCS-8685	9	8	7	7
Equipped with 4.3" LCD, speaker and microphone	HCS-4890N/80	9	9	9	8
	HCS-4890N/FM/80	9	9	9	8
Equipped with OLED, microphone	HCS-4860/80	31	31	30	29
Equipped with OLED, speaker and microphone	HCS-48U6/80	14	13	12	12
Equipped with OLED, speaker and microphone	HCS-4838/80	14	14	13	13
Equipped with OLED, array microphone	HCS-4813/HCS-4815	33	32	31	29
Equipped with 256*64 LCD, speaker and microphone	HCS-48U7/U8/U9/	13	12	12	11
Equipped with OLED, speaker and microphone	HCS-48U10/80	14	13	12	12
Equipped with 10" LCD, speaker and microphone	HCS-8635	7	7	6	6
Voting unit	HCS-4868/4869	52	50	48	46

HCS-4800WS/MC Web Software for Microphone Control

Microphone real-time monitoring and control, auto video tracking and other functions.

- Microphone control:
 - ◆ Turn on/off microphone, flashing /turn off microphone control interface, video tracking microphone;
 - ◆ Speak and request list: display delegate's information of opening and requesting microphones, turn off microphone(s), agreed /deny speak request and other operations;
- Unit setting :
 - ◆ Setting unit parameters, delegate identity/ permissions, device(s) information details;
 - ◆ Setting language of congress unit;
 - ◆ Turn on/off ambient microphone;

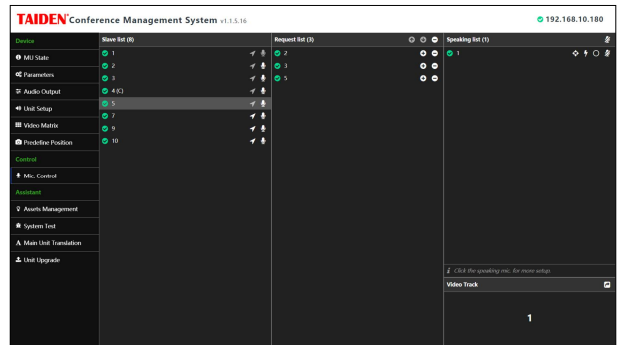

HCS-4800WS/MC.....Web Software for Microphone Control

HCS-4800WS/AO Web Software for Audio Output

Build-in audio processor in main unit, input and output parameters can be adjust independently.

- Adjust gain and balance (5) for each microphone, adjust volume and frequency response to perfect effect.
- 2 audio line input or 1 audio line output +1 microphone input, gain and EQ for each input can be adjust independently, +48V phantom power supply at microphone input, connect to condenser microphone directly
- 2 outputs, 31 GEQ+ pressure limiter+ delay device, EQ setting included narrow band, normal and wide band
- Real-time input/output level display
- Three frequency modes: normal, teleconferencing and external processor
- Support scenes saving for quick switch and use
- Support mutli-function audio input and output, system extension flexibly

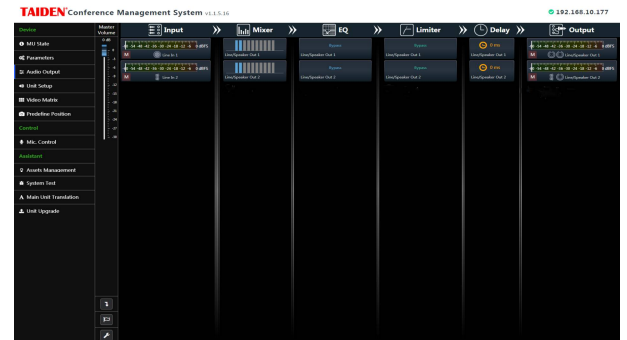

HCS-4800WS/AO.....Web Software for Audio Output

HCS-4800WS/VT Web Software for Video Track

Video Tracking: Cooperate with camera and video switchers to realized auto video tracking function, including:

- Video Matrix: Base on video device and video switch connection, offer input and output channels for computer signal, camera(s) and other video(s)
- Video Switch: Base on video matrix setting to switch signal input and output
- Predefine Position: Setting and adjusting predefine position
- Panorama Control: Filming the conference room by controlled camera(s)

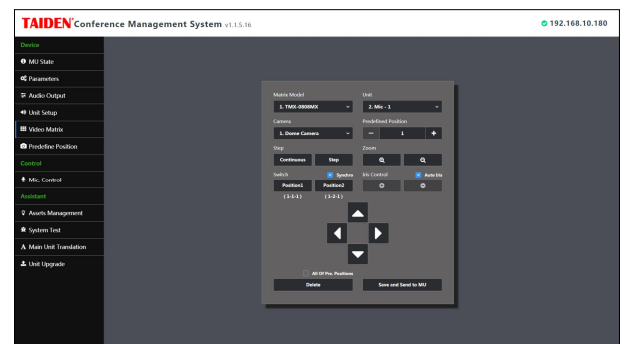

HCS-4800WS/VT.....Web Software for Video Track

HCS-4800 Series Application Software

HCS-4800 application software is comprehensive, reliable and user-friendly. But it is also an easy care software system which helps the operator to manage the conference efficiently from the very beginning of a meeting until the post-meeting work. With the PC installed HCS-4800 application software connected into the Fully Digital Conference System, the operator can manage all aspects of the conference centrally. The operation turns out to be easy and efficient.

HCS-4800 application software is a modularized software with various function:

- Basic System Setup Management Software (HCS-4510)
- Professional Venue Design Software (HCS-4512)
- Professional Venue Design Software (HCS-4512S)
- Microphone Management Software (HCS-4513)
- Voting Management Software (HCS-4514)
- Video Control Software (HCS-4515)
- Simultaneous Interpretation Software (HCS-4516)
- Intercom Software (HCS-4518)
- Synchronous Audio Recording Management Software (HCS-4519)
- Multi-User Conference Control Software (HCS-4521)
- Dual PC Server Hot Spare Software (HCS-4522)
- Dual System Main Unit Hot Spare Software (HCS-4525)
- Touched/Contactless IC-Card Sign in Management Software (HCS-4526)
- Fingerprint Identification Management Software (HCS-4529)
- Electronic Nameplate Management Software(for HCS-1082 series E-ink nameplate) (HCS-4531)
- Electronic Nameplate Server Software (for HCS-1082N series E-ink nameplate) (HCS-4532)
- Congress Service Management Software (HCS-8439)
- Booth Management (HCS-4544S)



HCS-4510 Basic Software

Basic software consists of an amount of facilities, e.g. room layout design (normal edition), conference management, main unit configuration, contribution unit configuration, information display, system detection, system report, and user management.

Room design facility

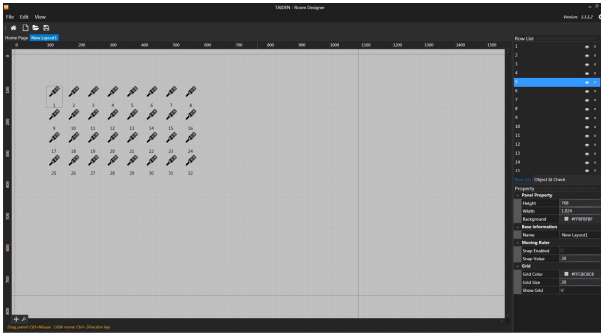

Room design (normal edition)

Functions

Converts the venue seating into an intuitive, graphical and controllable interface as a basis for further use, according to the actual layout of the venue

- Self-designing the background picture and color, supporting pictures of any size
- Microphone number, amount of microphones per line, icon type - icon transparency optionally
- Freely drag and drop the microphone icon
- Configuration room settings at any time via "Property" item
- Save/open files for file management
- Especially suitable for small-scale and medium-sized meeting room/hall. The professional edition of venue design module offers more facilities described in HCS-8512 Professional Venue Design Module

Conference information management

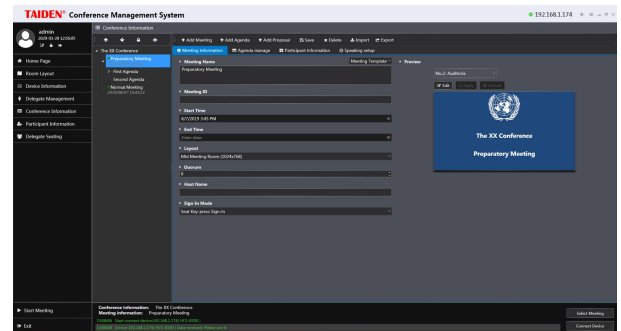

Conference information

Functions

Comprehensive conference information management facility, for clear and easy user management.

- Includes conference name and meeting information
- Each conference consists of several meetings
- Creation of a new meeting for appointed conference
- Meeting:
 - ◆ Meeting content: meeting name, layout, meeting start/end time, sign in mode and quorum and conference content
 - ◆ Agenda manage: generate agenda from DB or load from file
 - ◆ Participant information: add participants for current meeting
 - ◆ Speaking setup: speaking setup for current meeting
 - ◆ Display of convoked meetings in distinct colors
 - ◆ Locking a convoked meeting for meeting data protection
- Freely switch between the meetings to manage

Main unit configuration facility

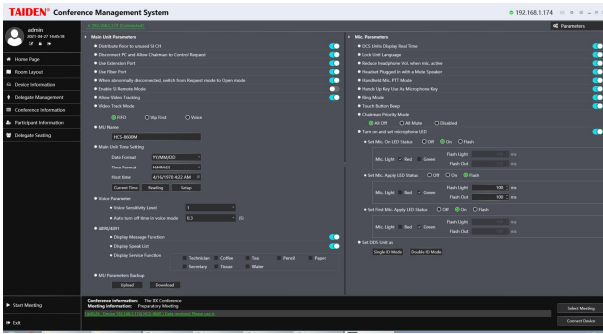

Parameters setup

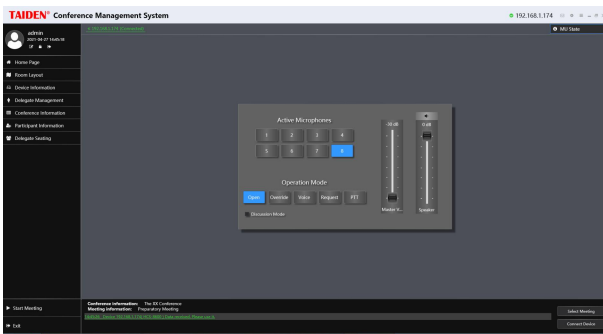

MU state

- Microphone Parameters:
 - ◆ DCS Units Display Real Time: select whether the contribution units display real time or not
 - ◆ Lock Unit Language:
 - ◆ Reduce headphone Vol. when mic. active: select whether reduce headphone volume or not when Mic. active
 - ◆ Headset Plugged in with a Mute Speaker
 - ◆ Handheld Mic. PTT Mode: force handheld microphone to PTT mode
 - ◆ Hands Up Key Use As Microphone Key: hands-up key is used as microphone On/Off key except discussion mode;
 - ◆ Ring Mode: turn on/off all ring tones of the conference units when applying to speak, on receipt of a short message or on IC card insertion
 - ◆ Chairman Priority Mode: set the operation when the chairman unit presses the priority button
 - All Off: turn off all microphones of delegates
 - All Mute: mute all microphones of delegates temporarily; once the button released, the former state is restored
 - Disabled: disable chairman unit's priority function. If disabled, the function of the priority key is the same as the Mic. On/Off key
 - ◆ Turn on and set microphone LED: LED color: red, green or yellow, LED Status: On, Off or Flash
 - ◆ Set DDS Unit mode: single ID mode or Double ID mode

Functions

Module provides **Parameters setup** and **MU state** sub-modules.

■ **Parameters:**

- Main Unit Parameters:
 - ◆ Distribute floor to unused SI CH: select whether to distribute floor to unused SI channel automatically or not when the SI channel is not operated
 - ◆ Disconnect PC and Allow Chairman to Control Request
 - ◆ Use Extension Port: select whether use extension port or not
 - ◆ Use Fiber Port: select whether use fiber port or not
 - ◆ When abnormally disconnected, switch from Request mode to Open mode
 - ◆ Enable SI Remote Mode
 - ◆ Allow Video Tracking: turn on/off video track function
 - ◆ Video Track Mode: set video track mode as FIFO, VIP First or Voice when video tracking
 - ◆ MU Name: set main unit name
 - ◆ Main Unit Time Setting: setup the time displayed on the LCD of the main unit's front panel
 - Current time: display the time of the DCS server
 - Reading: read the time of the main unit
 - Setup: set the time of the main unit according to the time of the DCS server
 - ◆ Voice Sensitivity Level: set the sensitivity "Level" to open microphone in voice mode
 - ◆ Auto turn off time in voice mode: set the sensitivity "Off Time" to close microphone in voice mode
 - ◆ 4890/4891: set content display for HCS-4890/4891 series congress unit (Message/Speak List/ Service)
 - ◆ MU Parameters Backup

- **MU state:** synchronously display and adjust the status of the Congress Main Unit, for flexible control of the CMU by the operator
 - ◆ Active Microphones (1~8)
 - ◆ Operation mode (Open/Override/Voice/Request/PTT)
 - ◆ Master Volume (-30 dB ~ 0 dB)

Contribution unit configuration facility

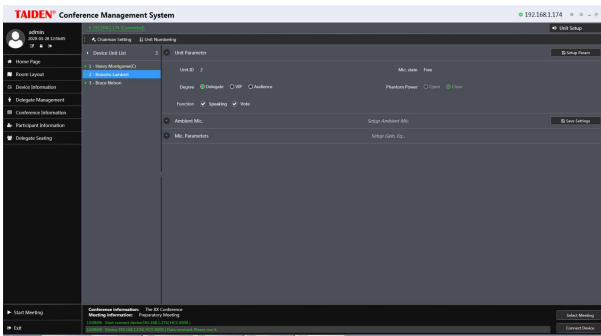

Set up contribution unit interface

Information display

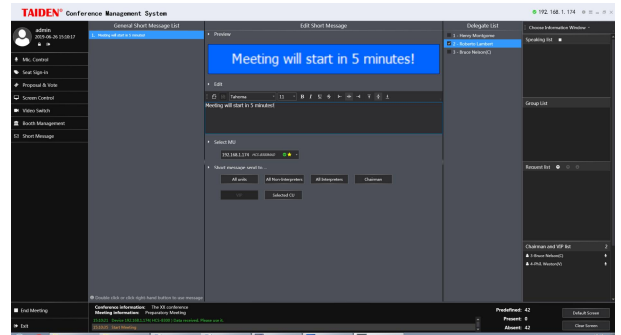

Short message

Functions

Set up and reconfigure internal parameters of the contribution unit by the administrator.

Parameters include:

- Contribution unit degree (Delegate/VIP/Audience)
- Built-in facilities (Speaking/Vote/IC card sign-in)
- Unit language
- Microphone sensitivity and EQ
- Easy reconfiguration of the internal settings
- Easy selection of any chairman unit to be executive chairman unit

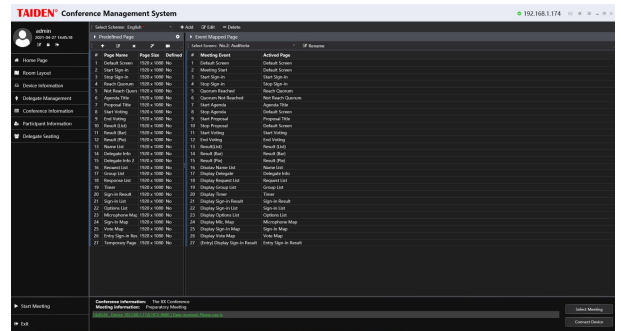

Screen management

User management

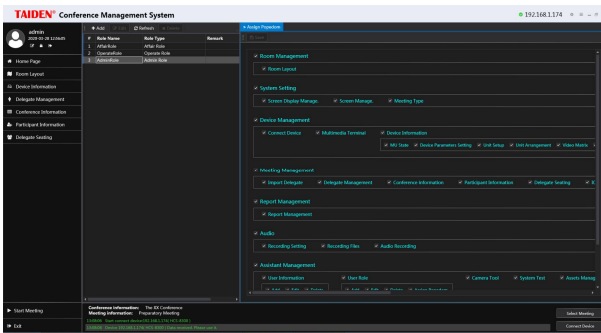

User management interface

Functions

Create/delete a user, change user password and authorization

- Create a new user, and set his/her account, password, authority
- Change user's password and authorization
- Supports deleting a user

Functions

Include screen management and short message.

- **Screen management:** design of a screen and its related activated event
 - ◆ Set distinct screen projects for distinct conferences and languages
 - ◆ Predetermination of screen page contents: includes page color, page name, page size, etc.
 - ◆ Editing screen page contents: includes add text, picture, delegate's photo, voting results, etc.
 - ◆ Select the page to display when conference event starts. Each conference event corresponds to a particular screen page
 - ◆ Rename screen for more convenience
- **Short message:**
 - ◆ Write short message: write short message up to the permitted message size, synchronous display for preview purposes. Supports various Chinese/English fonts and formats
 - ◆ Send short message: select the compiled short message and send it/them to the unit(s), e.g. all contribution units (CU), all interpreters / non-interpreters, chairman and selected CU etc.
 - ◆ Contribution unit should be equipped with LCD to receive and display the short message

System detection

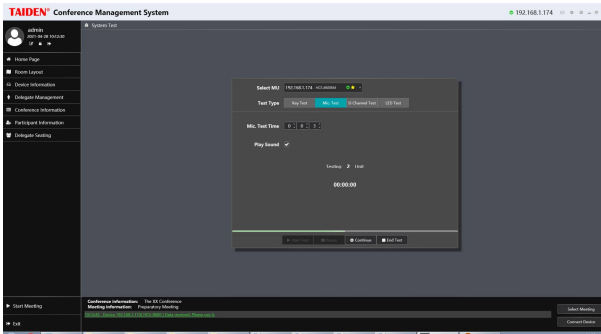

Key test interface

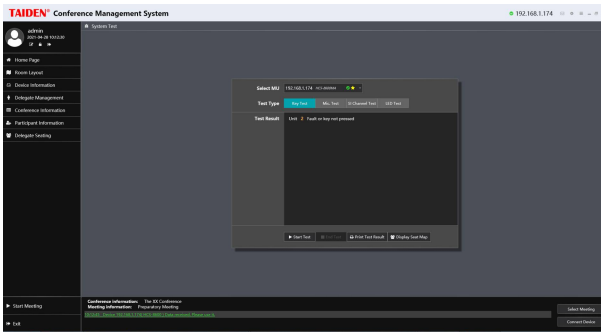

Microphone test interface

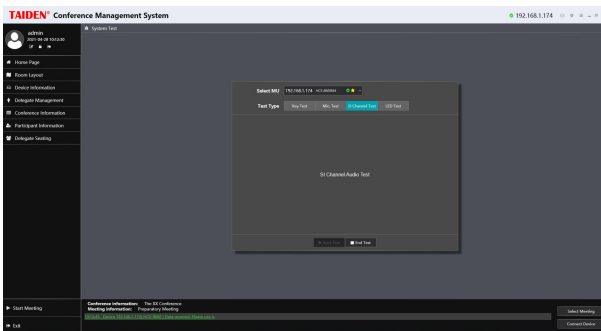

SI channel test interface

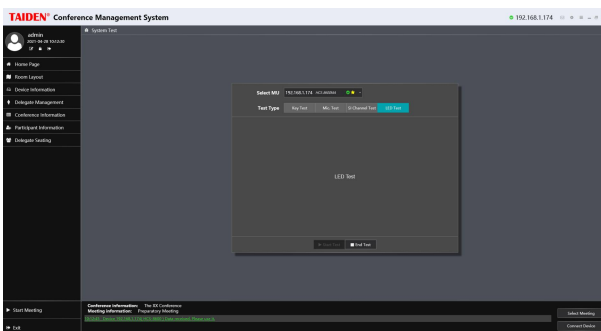

LED test interface

Functions

Online system test facility, including **microphone test**, **key test** and **SI channel test**.

- **Key test:** starts key test for all system-connected contribution unit
 - ◆ Main unit IP address display
 - ◆ Contribution units enter key detection state for key tests immediately on start of key test routine
 - ◆ Result display on software interface on routine completion
 - ◆ Supports printout
- **Microphone test,** includes:
 - ◆ Time setting for testing a microphone, valid for all microphones
 - ◆ Facility to issue white noise for testing assistance
 - ◆ Auto-detection of system-connected microphones with ID display of current tested microphone
 - ◆ Sequential automatic test procedure: once time setting value reached, the tested unit is cleared and the sequencing unit is processed
- **SI channel test:**
 - ◆ HCS-8685 will play the monitor channel name, and if the channel is not defined in the system, the sound "Floor" will be played
- **LED test:**
 - ◆ The LEDs (indicating light) on all connected contribution units will blink

Report system

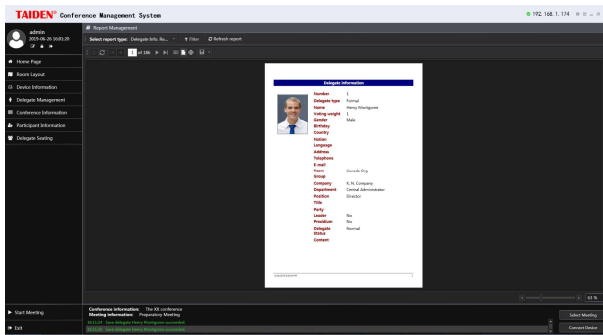

Report system

Functions

Conference information output from the software's database, for backup or printout purposes. The conference information includes:

- Delegate Information Report
- Seat Sign-in Report
- Seat Sign-in Name List
- Vote Result Report
- Vote Name List
- Congress Report
- Entry Sign-in Report

Ordering Information

HCS-4510.....Basic System Setup Management Software

HCS-4512 Professional Venue Design Software

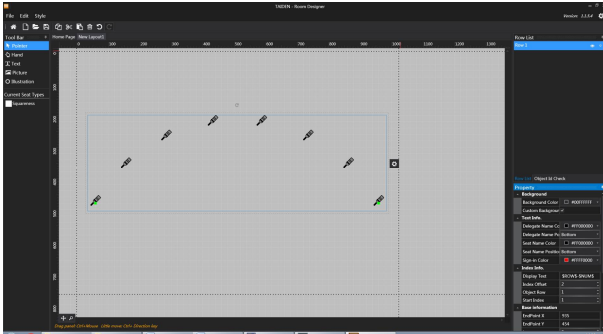

Venue design (professional)

Functions

Unlike the normal edition of the Venue Design Module, the professional version has additional powerful functions to design manifold layouts of venues. The main difference is the availability of functional buttons for file operation (toolbar buttons) and object operation (buttons below toolbar buttons) in the toolbars. In addition, the functions are also available in the file right-click pop-up menu. Moreover, the Properties dialog box is on right of the window for fast changing the properties of current object.

- File operation:
 - ◆ Venue design supports file operation, including: new, open, save as, save layout template and export
 - ◆ Create a new conference file: set the background color, room size and other parameters, including:
 - Room layout room
 - Background color
 - Size
 - Line number
 - Numbers per line
 - Seat icon
 - Transparent icon or not
 - Display as mic. icon or not
 - Background image
 - ◆ The parameters above can be changed at any time through "Property" item on the toolbar
 - ◆ Add seat/microphone icons line by line, 8 seats/microphones per line as default value. The amount of seats/microphones per line can be modified. While the normal edition can add only one seat at one go, the professional venue design module can add groups with more than one seat/microphone per group
 - ◆ Shifting facility for complete layout
- Define object:
 - ◆ Picture library with default (customized and/or recurrent) objects
 - ◆ Modifiable object information, e.g. object name, image path, distinguishable colors for displaying object images in different states (e.g. signed-in etc.)

- Powerful "Property" function: object attribute can be set and changed, including:
 - ◆ Set group name and object name
 - ◆ Set unique ID and ID display mode for every object, supporting different fonts and sizes
 - ◆ Set starting object status
 - ◆ Set a radian for the object group and design seat layout according to true seating positions
 - ◆ Set start index of the object group
 - ◆ Change the amount of the units in an object group
 - ◆ Set numbering increment
 - ◆ Set initial background color and whether transparent or not
 - ◆ Set start and end coordinates of object group
- Object ID check facilities
- Support object copy, cut, paste and delete operation
- Object arrangement can be changed

Ordering Information

HCS-4512.....	Professional Venue Design Software
HCS-4512S.....	Professional Venue Design Software (Independent setup)

HCS-4513 Microphone Management Software

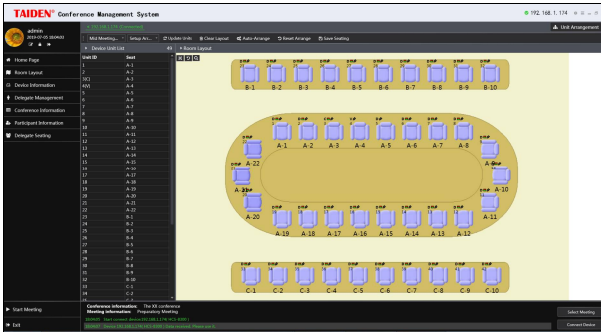

Unit arrangement

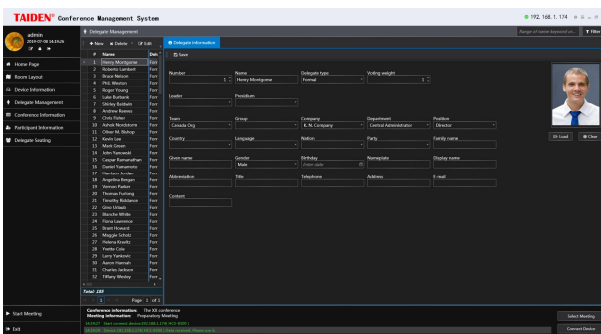

Delegate information

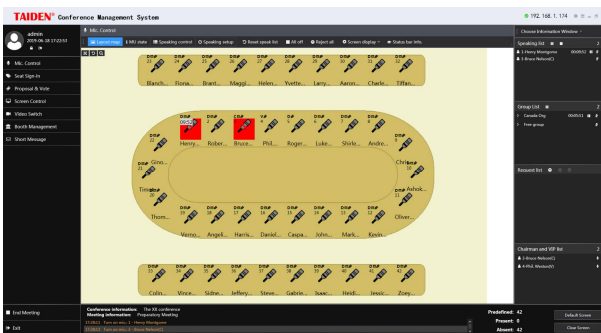

Microphone control

- Locate seat position by menu operation
- Operate the arranged units to check the arrangement
- **Delegate management** includes three sub-modules: delegate information, participants and delegate authority
 - ◆ Delegate information: create and manage the delegate's database
 - Import/Export delegate information
 - Edit delegate information: number, type, name, voting weight, leader (yes or no), presidium (yes or no), etc. Supports individual picture in the database
 - Users can customize the options in the above items
 - Customer-specific options for above items
 - Fast search facility
 - Database updatable
 - ◆ Participants: select the delegates to participate in the conference from the database
 - List delegate information by filter
 - Group adding function by filter
 - ◆ Delegate authority:
 - Degree: chairman or delegate
 - Authority: speak, vote and vote board
- **Microphone control:** combined with venue design, seating arrangement, delegate management, conference management and microphone setup, for controlling and monitoring current microphone status, as well as automatic video tracking. Facility includes:
 - ◆ Microphone on/off control
 - ◆ Close all active microphone
 - ◆ Approve/deny delegates' speaking requests
 - ◆ Deny all speaking requests
 - ◆ Delegate speech timing
 - ◆ Record and save speaking
 - ◆ Parliamentary mode control
 - ◆ Detailed information available from the delegate database for online display purposes
 - ◆ If cooperating with an automatic video tracking system, camera presets can be made for each discussion unit to transmit speaker's picture simultaneously to a hall display

Ordering Information

HCS-4513.....Microphone Management Software

Functions

Seat arrangement, delegate management and microphone control sub-modules

- **Seat arrangement** facility includes delegate seating and unit arrangement function modules
 - ◆ Delegate seating is used to assign seats for the delegates, e.g.:
 - Assign a single seat for each delegate
 - Section seating, automatic seat assignment for a group of delegates, supports new assignment – in parts or entirely
 - Clear a single seat if required for a new assignment
 - ◆ Unit arrangement: assign the Congress Units to the corresponding positions based on the true delegate seating, current cabling and layout:
 - Unit arrangement, assign the Congress Units to the true delegate seating
 - Delete unit, reassign the units

HCS-4514 Voting Management Software

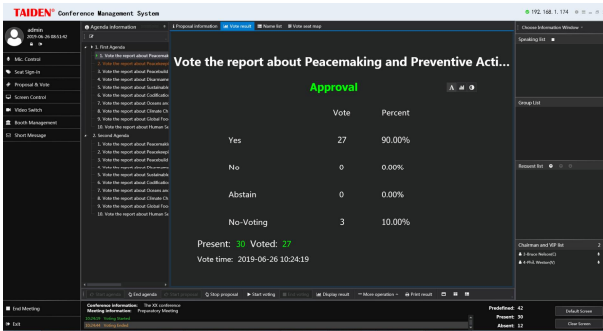

Topics and voting

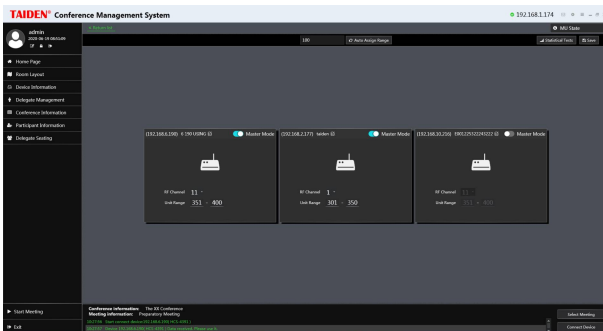

RF wireless setup

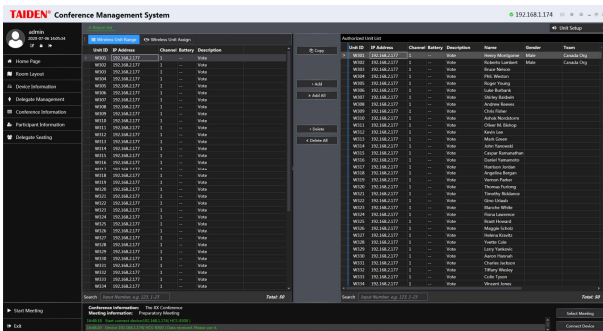

Wireless Voting Units Management

Functions

Voting management, seat arrangement and delegate management sub modules.

■ Voting management:

- ◆ Topics information management
 - Set up, save, add or delete topics file before the meeting
 - Open topics control interface and display topics content to large screen
 - Printout the topics list and information and distribute to delegates as meeting information
 - Multiple voting facilities available, suitable for various conferences, including:
 - ◆ For/Against
 - ◆ Parliamentary: YES/NO/ABSTAIN
 - ◆ Questionnaire: 1/2/3/4/5
 - ◆ Audience response: --/-/0/+/>++
 - ◆ Parliamentary (NPPV): YES/NO/ABSTAIN/NPPV

- ◆ Appraisal:
 - ◆ satisfied (four keys voting: perfectly satisfied/satisfied/basically satisfied/unsatisfied) (three keys voting: satisfied/basically satisfied/unsatisfied) (two keys voting: satisfied/unsatisfied)

- ◆ Qualified (four/three/two keys voting)
- ◆ Competent (four/three/two keys voting)
- Control modes: chairman control / operator control / time controlled voting
- Calculation: predefined or in relation to the participants attending the meeting in person
- Register mode: nominative/ballot
- Validity mode: first key press valid/last key press valid
- Pass rate: between 1% and 100%

- ◆ Multi-proposal voting at one time (for HCS-4368DM series and paperless multimedia congress terminal)
- ◆ Display voting result to large screen
- ◆ Clear and vivid voting result display modes (numeric/bar/pie)
- ◆ Print or save voting result
- ◆ Sign-in before the voting to improve the security and validity of voting result

■ Seat arrangement facility includes delegate seating and unit arrangement function modules

- ◆ Delegate seating is used to assign seats for the delegates, e.g.:
 - Assign a single seat for each delegate
 - Section seating, automatic seat assignment for a group of delegates, supports new assignment – in parts or entirely
 - Clear a single seat if required for a new assignment
- ◆ Unit arrangement: assign the Congress Units to the corresponding positions based on the true delegate seating, current cabling and layout:
 - Unit arrangement, assign the Congress Units to the true delegate seating
 - Delete unit, reassign the units
 - Locate seat position by menu operation
 - Operate the arranged units to check the arrangement

■ Delegate management includes three sub-modules: delegate information, participants and delegate authority

- ◆ Delegate information: create and manage the delegate's database
 - Import/Export delegate information
 - Edit delegate information: number, type, name, voting weight, leader (yes or no), presidium (yes or no), etc. Supports individual picture in the database
 - Users can customize the options in the above items
 - Customer-specific options for above items
 - Fast search facility
 - Database updatable
- ◆ Participants: select the delegates to participate in the conference from the database
 - List delegate information by filter
 - Group adding function by filter
- ◆ Delegate authority:
 - Degree: chairman or delegate
 - Authority: speak, vote and vote board

Simultaneous use with wireless voting system, include RF wireless setup, statistic test, voting units management and voting units assignment.

- RF wireless setup:
 - ◆ amount of voting units
 - ◆ set a transceiver as backup
 - ◆ range of RF channel
 - ◆ range of wireless voting unit will be automatically assigned equally after setup
- Statistic test:
 - ◆ Detect the coverage of each wireless transceiver in the meeting room, and optimizing the placement of wireless transceivers to obtain the largest possible coverage with less wireless transceivers
 - ◆ Detect the working status of all wireless voting units and wireless transceivers to find out those wireless voting units or wireless transceivers which may not work properly in advance, and select a clean frequency for wireless transceivers (there are 12 optional frequencies)
- Wireless voting units management
 - ◆ Add wireless voting units into the conference
- Wireless voting units assignment
 - ◆ Assign wireless voting units to participators for nominative voting

Ordering Information

HCS-4514_..... Voting Management Software (support wired and wireless mixed use, including delegate management, multiform voting, multi-proposal voting)

HCS-4515 Video Control Software

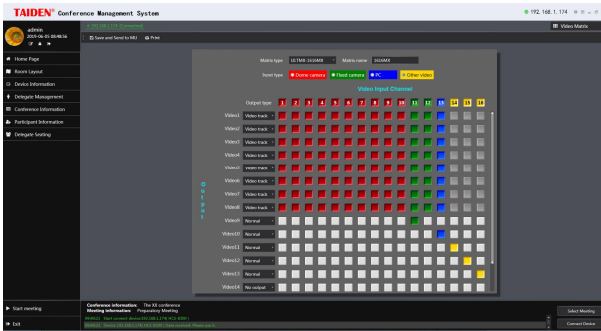

Video matrix

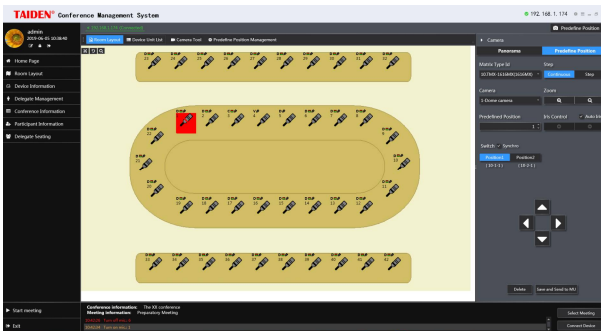

Camera control

Functions

Carries out automatic video tracking when cooperating with camera and video switch unit.

- Set up video matrix: set input/output channels for computer, camera and other video apparatus according to the connections between video equipment and video switch unit. The configuration can be sent to the Congress Main Unit for synchronization
- Video switch: switch among different input and output video signals according to the video matrix
- Camera preset: cooperating with microphone management module to set and adjust the camera preset for each seat/microphone and to transmit speaker's video picture simultaneously to a hall display
- Camera control: preset the panorama of the conference venue

Ordering Information

HCS-4515.....Video Control Software

HCS-4516 Simultaneous Interpretation Software

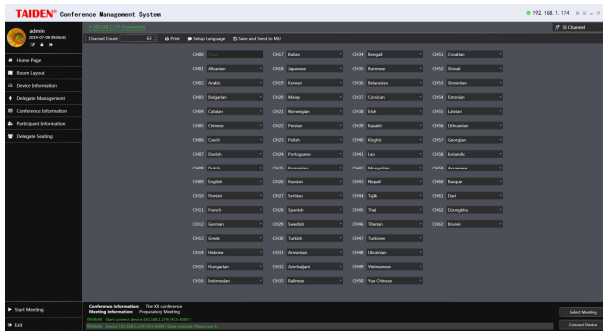

Interpretation channel setup

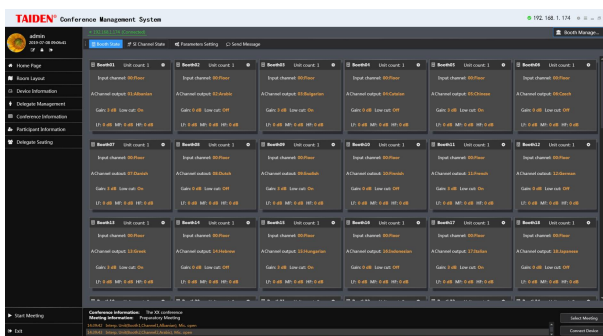

Interpreter booth status

Functions

Set up the simultaneous interpretation channels and interpreter booth(s):

- Simultaneous interpretation channel setup:
 - ◆ Set the channel number and language for each channel and save into the database
 - ◆ Set language and its abbreviation
 - ◆ Send the configuration to the Congress Main Unit for synchronization
 - ◆ Display Congress Main Unit configuration on the window
- Set up interpreter booth(s)
 - ◆ Set the number of interpreter booth, and save into database
 - ◆ Set the outgoing for channel A, B and C of each booth
 - ◆ Set the auto-relay booths for each interpreter booth
 - ◆ Assign the interpreter booth afresh after booths combination
 - ◆ Send configuration to the Congress Main Unit for synchronization
- Manage interpreter booth: synchronously control and communicate with the booth during the meeting
 - ◆ Booth status and Channel status
 - ◆ Switch output channel
 - ◆ Set up interpreter unit microphone parameters (Gain, EQ and Lowcut)
 - ◆ Close interpreter unit microphone

Ordering Information

HCS-4516.....Simultaneous Interpretation Software

HCS-4518 Intercom Software

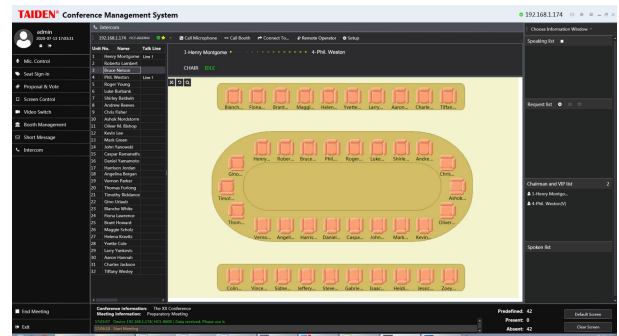

Intercom interface

Functions

Provides bidirectional communication among the chairman, delegates, interpreters and operators:

- Multiplex communication session available
- Search facilities, fast locating of a delegate within the venue
- Easy to operate via control menu
- Communication session guided by the operator
- Enable remote operation
- Intercom only available for Congress Units equipped with LCD
- Paperless Multimedia Congress Terminal can initiate intercom without an operator

Ordering Information

HCS-4518.....Intercom Software

HCS-4519 Synchronous Recording Software

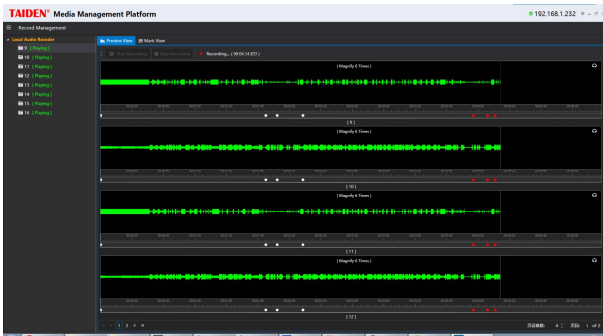

Audio record interface

HCS-4521 Multi-User Console Software

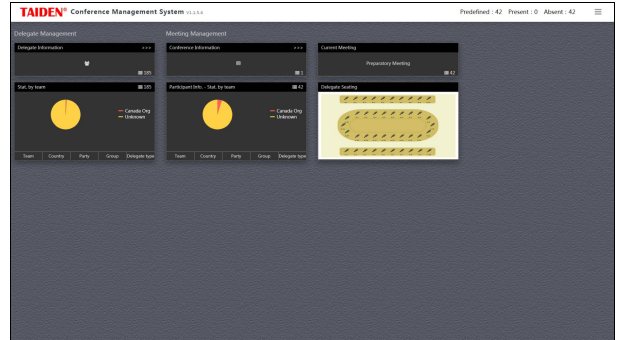

The primary window of multi-user console

Functions

Records speakers' audio information:

- Integrated into **TAIDEN** media management platform, easy to operate
- Recording Setting
 - ◆ Add recorder device
 - ◆ Set up record audio quality
 - ◆ Configure recording channel
- Audio recording
 - ◆ Begin/end automatic recording according to microphone on/off
 - ◆ Once microphone enabled, speaking delegate's voice is recorded in audio file (MP3 format)
 - ◆ Add/delete/search marker for audio file
 - ◆ Increase/decrease start/end time for marker
 - ◆ Edit marker name, content, and upload file for marker
- Recording files:
 - ◆ Search facilities, search audio record file needed to playback quickly (by conference ID, speaker, begin time, continuous time, etc.)
 - ◆ Playback all recordings one by one
 - ◆ Recorded file playback, fast play, pause/stop, etc.
 - ◆ General file format saving: saved file playback by conventional media player
 - ◆ Delete any recorded file or all recorded files

Ordering Information

HCS-4519.....Synchronous Audio Recording Management Software

Functions

If more than one operator is involved, a multi-user console is available for controlling speaking and voting, apart the system application software.

- Input web address on browser to access multi-user console
- Scanning QR code to access multi-user console
- User name, password and authority were created by management system
- User controls conference in his/her authority

Ordering Information

HCS-4521.....Multi-User Conference Control Software

HCS-4522 Dual PC Server Hot Spare Software

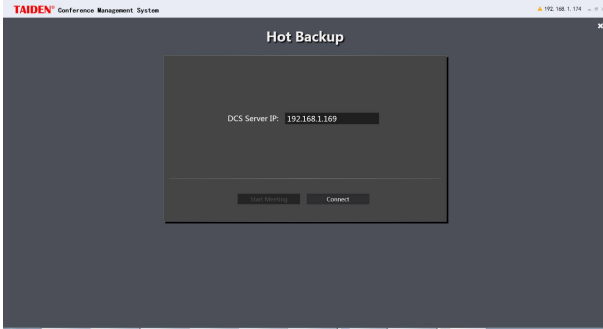

Start to backup interface

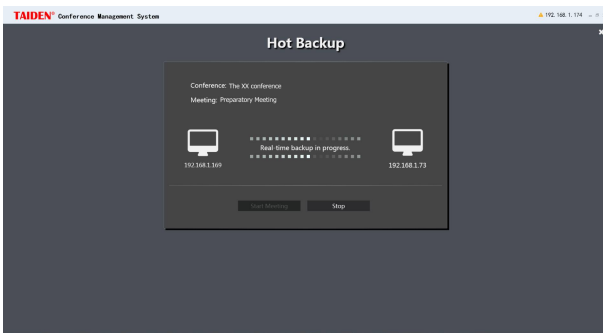

Backing up interface

Functions

Dual PC server hot-spare is a malfunction protective structure. If the main operating computer breaks down during a conference, the backup computer immediately substitutes the main computer and continues conference management.

After connection to main operating computer, the backup console application first starts an automatic backup (incl. database and conference related information). If there is any change in the database, the backup console application will update backup automatically.

Ordering Information

HCS-4522.....Dual PC Server Hot Spare Software

HCS-4525 Dual System Main Unit Hot Spare Software

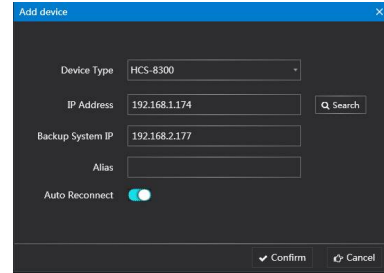

Connect to CMU

Functions

Dual main unit hot spare is a malfunction protective structure. Besides the Congress Main Unit, user can set another Congress Main Unit as backup Congress Main Unit and connect it to the system. If the Congress Main Unit breaks down during the conference, the backup Congress Main Unit substitutes the Congress Main Unit and system software will connect to backup Congress Main Unit automatically, ensuring consistency of the conference.

Ordering Information

HCS-4525.....Dual System Main Unit Hot Spare Software

HCS-4526 Touched/Contactless IC-Card Sign-in Management Software

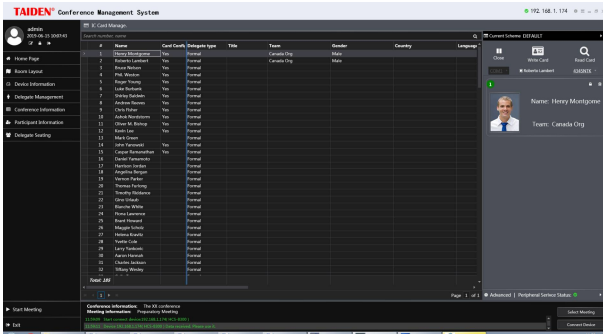

IC-Card distribution

HCS-4529 Fingerprint Identification Management Software

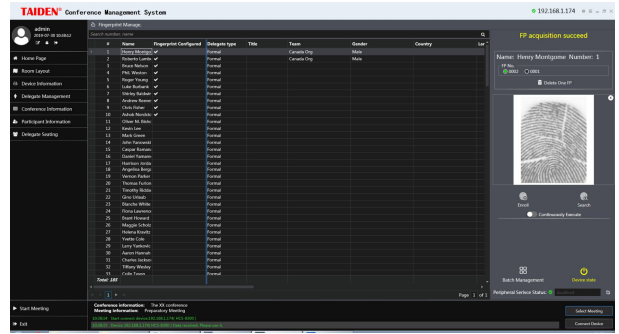

Fingerprint management

Functions

IC-Card distribution, IC-Card loss/activate and delegate management

- **IC-Card distribution:**
 - ◆ The IC-Card contains conference number, participant's number, identity, rights, etc.
 - ◆ Card authentication restricted to one conference facility. New authentication subject to IC-Card rewriting
 - ◆ Write IC-Card before IC-Card distribution
- IC-Card loss: report card loss. Cards counted for lost cannot carry out conference sign-in
- IC-Card activate: activate the lost card when it comes back
- **Delegate management** includes three parts: delegate information, participants and delegate authority
 - ◆ Delegate information: create and manage the delegate's database
 - Import/Export delegate information
 - Edit delegate information: number, type, name, voting weight, leader (yes or no), presidium (yes or no), etc. Supports individual picture in the database
 - Users can customize the options in the above items
 - Customer-specific options for above items
 - Fast search facility
 - Database updatable
 - ◆ Participants: select the delegates to participate in the conference from the database
 - List delegate information by filter
 - Group adding function by filter
 - ◆ Delegate authority:
 - Degree: chairman or delegate
 - Authority: speak, vote and vote board
 - Chairperson privilege is needed when sign-in at chair unit (Free seating)

Ordering Information

HCS-4526.....Touched/Contactless IC-Card Sign-in Management Software

Functions

Fingerprint management and delegate management

- **Fingerprint management:**
 - ◆ Enroll fingerprint and the fingerprint data will be numbered automatically by the system
 - ◆ Search fingerprint and the result is listed with matching score
 - ◆ Delete fingerprint before meeting started
 - ◆ Import/export fingerprint data from/to file before meeting started
- **Delegate management** includes three parts: delegate information, participants and delegate authority
 - ◆ Delegate information: create and manage the delegate's database
 - Import/Export delegate information
 - Edit delegate information: number, type, name, voting weight, leader (yes or no), presidium (yes or no), etc. Supports individual picture in the database
 - Users can customize the options in the above items
 - Customer-specific options for above items
 - Fast search facility
 - Database updatable
 - ◆ Participants: select the delegates to participate in the conference from the database
 - List delegate information by filter
 - Group adding function by filter
 - ◆ Delegate authority:
 - Degree: chairman or delegate
 - Authority: speak, vote and vote board

Ordering Information

HCS-4529.....Fingerprint Identification Management Software

HCS-4531 Electronic Nameplate Management Software (for HCS-1082 series E-ink nameplate, congress main unit needed)

Ordering Information

HCS-4531.....Electronic Nameplate Management Software
(for HCS-1082 series E-ink nameplate)

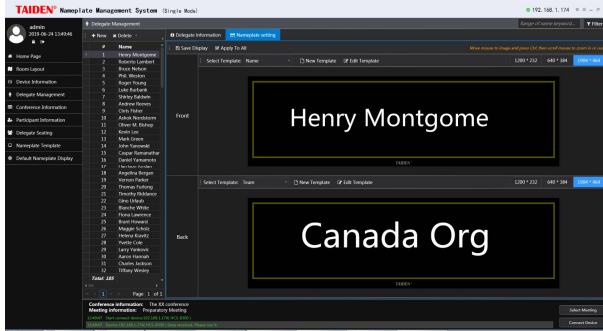

Delegate Management

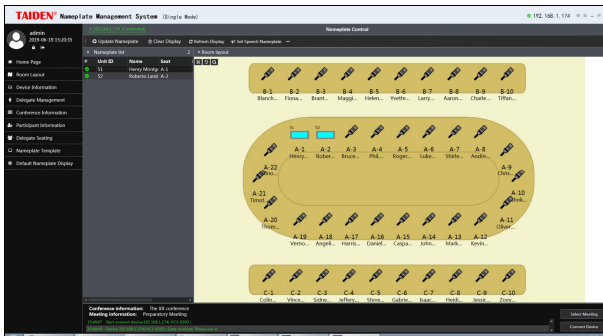

Nameplate Control

Functions

TAIDEN electronic nameplate system works together with TAIDEN HCS-1082 series E-ink nameplate to realize soft, flicker-free, glare-free and power saving electronic nameplate function. It has two work modes: Single mode and DCS mode.

- Single mode
 - ◆ Assistant: supports user information and user role
 - ◆ Room layout: add, manage and design room layouts
 - ◆ Device management: add device and connect device
 - ◆ Meeting management: add/edit meeting information and edit delegate information, design nameplate template;
 - ◆ Delegate management: create and manage the delegate's database; set up display effect for delegate screen;
 - ◆ Nameplate/Delegate seating: assign the nameplate/delegate to the corresponding positions based on the true seating layout
 - ◆ Nameplate control: includes nameplate number, seating and display controlling
- DCS mode:
 - ◆ Get meeting database from DCS server; including meeting information, room layout, delegate information, etc.
 - ◆ Nameplate control: includes nameplate number, seating and display controlling

HCS-4532 Electronic Nameplate Management Software

(for HCS-1081/HCS-1082N series E-ink nameplate, w/o congress main unit)

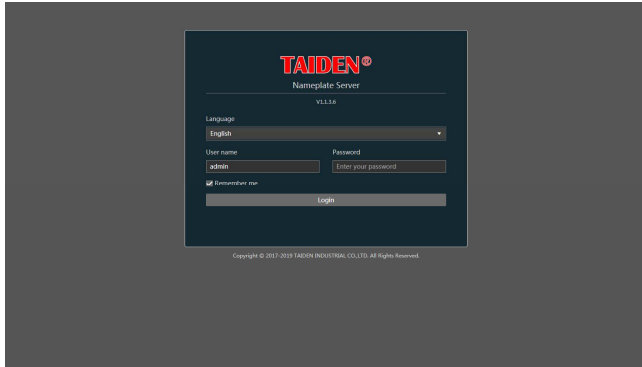

Login

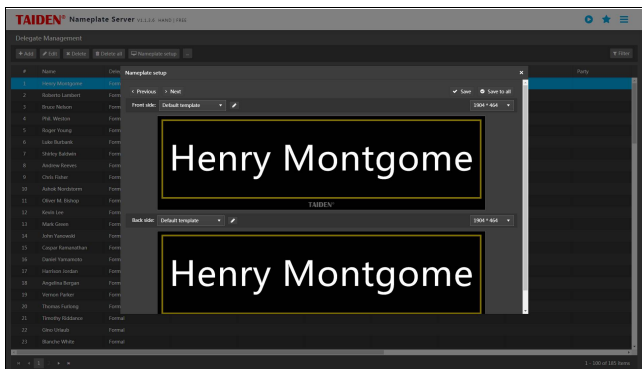

Nameplate Setup

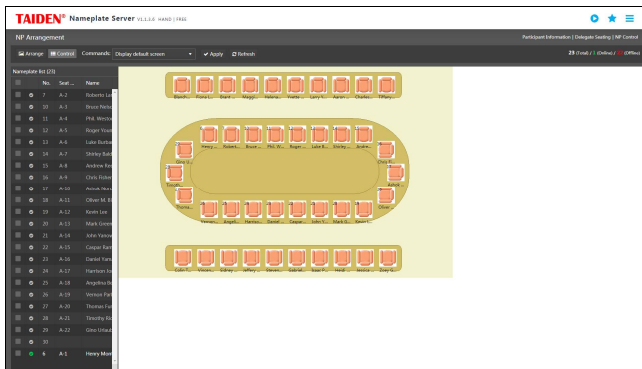

Nameplate Control

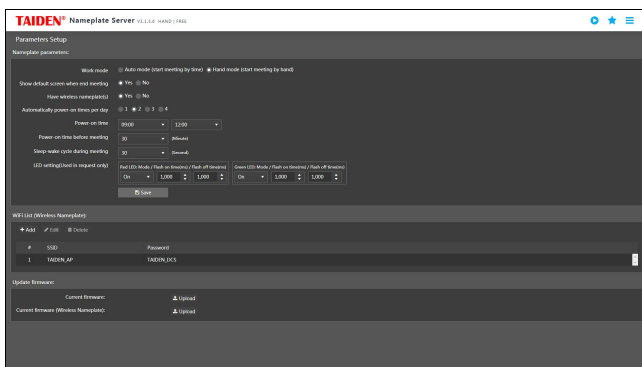

Parameters Setup

Functions

TAIDEN electronic nameplate server is an electronic nameplate control and management platform based on network, cooperating with TAIDEN HCS-1081/1082N series E-ink nameplate. After configure electronic nameplate server, users can control the system through any computer which can access the server. It has two work modes: Auto mode and Hand mode. When work on Auto mode, the nameplate server will start meeting by time automatically.

- Meeting management
 - ◆ Meeting information: add/edit conference and meeting information
 - ◆ Delegate information: create and manage the delegate's database; set up display effect for delegate screen
 - ◆ Participant information: select the delegates to participate in the conference from the database
 - ◆ Delegate seating: is used to assign seats for the delegates, e.g.
- Nameplate management
 - ◆ Nameplate control: control nameplate display (default screen, delegate screen, device information), Update firmware, Restore factory setting, Inverse, Extension port setting, Agree/Add request, Cancel request, etc.
 - ◆ Nameplate arrangement: assign the nameplate to the corresponding positions based on the true seating layout
 - ◆ Nameplate template: design nameplate template
 - ◆ Nameplate default Display: select and edit default display
 - ◆ Parameters setup: include setup nameplate parameters and update firmware file
- System settings
 - ◆ Room layout: add and manage room layout
 - ◆ User management: create/delete a user, edit user password

Ordering Information

HCS-4532.....Electronic Nameplate Server
(for HCS-1081/1082N, w/o congress main unit,
HCS-4512S needed)

HCS-4539 Congress Service Management Software

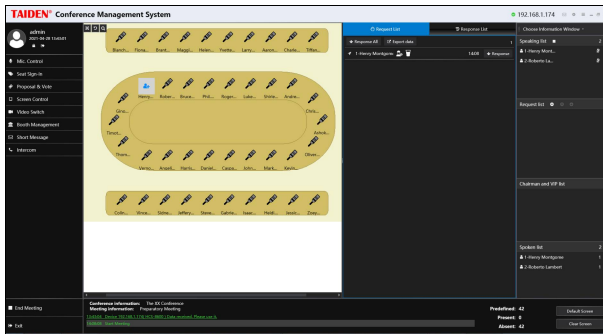

Congress Service

Functions

Paperless Multimedia Terminals and HCS-4890/4891 series congress units have a service request function. The participants can call for a service, the participant's name, seat and service type will be displayed on operator's monitor.

Ordering Information

HCS-4539.....Congress Service Management Software

HCS-4544S Booth Management Software

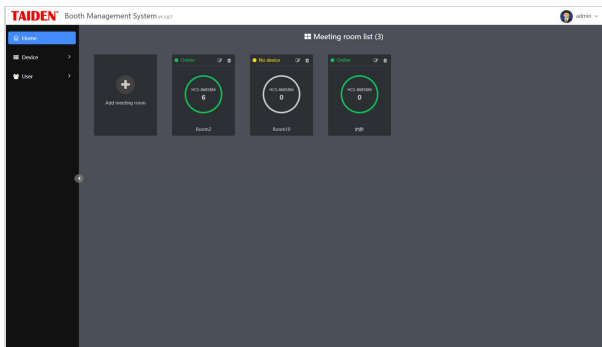

Meeting room list

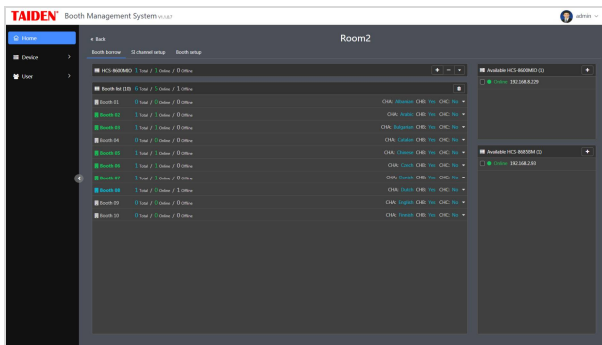

Booth borrow

Functions

Cooperating with the HCS-8600MIO series Audio Input & Output Device and the HCS-8685BM for booth management. Booth management Software can realize booth deployment, cable connections do not need to be changed, includes:

- Meeting room list: manage meeting rooms
- Booth borrow: add HCS-8600MIO to meeting room and distribute HCS-8600BM to interpreter booth;
- SI channel setup: setup SI channel or get channel information from main unit;
- Booth setup: setup booth or get booth information from main unit;
- Device management: manage devices of HCS-8600MIO and HCS-8685BM, and configure server information for the devices
- User: add user information, the TAIDEN Booth Management Software can be configured on the server in the conference center, and users can log in to the system through any computer that accesses the server to perform corresponding operations.

Ordering Information

HCS-4544SBooth Management Software
(HCS-8600MIO and HCS-8685BM needed)

HCS-4547 Internet Extended Screen

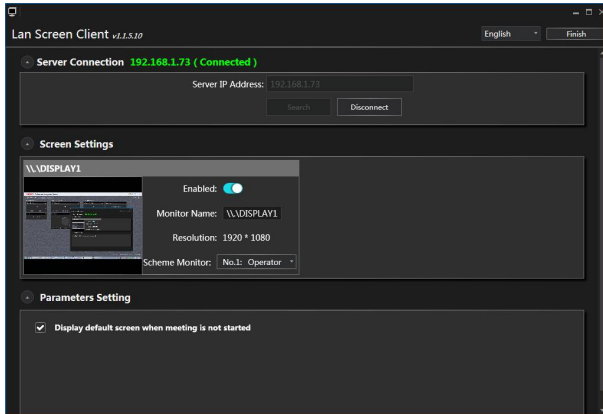

Lan extension screen

Functions

After installing this software, you can set the computer screen in the network as an extended screen without physical cable connection.

- Server Connection: input Server IP address (the computer installed Taiden CMP Service) or click “Search” button to broadcast Server IP address to connect;
- Screen Settings: enable/disable screen, modify monitor name, and select scheme monitor;
- Parameters Setting: display default screen or not when meeting is not started.

Ordering Information

HCS-4547_.....Lan Extension Screen Software (set the computer screen in the network as an extension screen, suitable for local and remote conference)