



**Smart Classroom System**

<b>Smart Classroom System</b> .....	<b>3</b>
<b>TES-560X Series Digital Infrared Wireless Microphone</b> .....	<b>5</b>
TES-5604N_W      Digital Infrared Wireless Microphone (white, built-in rechargeable lithium battery, with laser pointer, excl. adapter, used with TES-5600NS_W neck lanyard or TES-5600CLP clip).....	5
TES-5608AN      Digital Infrared Clip Microphone.....	6
TES-5608BN/20      Digital Infrared Wireless Presenter (space grey, with digital laser pointer, built-in rechargeable lithium battery, with neck lanyard and belt case, excl. adapter).....	6
TES-5608CN/20      Digital Infrared Wireless Presenter (space grey, with laser pointer, built-in rechargeable lithium battery, with neck lanyard and belt case, excl. adapter).....	6
TES-1021      Clip Microphone.....	7
TES-1022      Single-ear Microphone.....	7
TES-1023      Head-worn Microphone.....	7
<b>TES-5675 Series Hanging Microphone</b> .....	<b>8</b>
TES-5675T      Hanging Microphone (Gray, round, 14 mm Cardioid unidirectional microphone used to pick up the audio of the teachers' lecture).....	8
TES-5675S      Hanging Microphone (Gray, round, omnidirectional microphone, used to pick up students' interactive audio).....	8
TES-5675H      Hanging Microphone (Black, heart-shaped unidirectionality, used to pick up the audio of the teachers' lecture).....	9
<b>TES-8100 Series Smart Classroom System Main Unit</b> .....	<b>10</b>
TES-8100MA      Smart Classroom System Main Unit (19-inch rack mounting, digital infrared audio reinforcement, support hanging microphone, built-in PA, network central control, network switch, wireless IOT, paging function, IP digital audio broadcasting, remote interaction).....	10
TES-8100MB      Smart Classroom System Main Unit (19-inch rack mounting, digital infrared audio reinforcement, support hanging microphone, built-in PA, network central control, network switch, wireless IOT, paging function, IP digital audio broadcasting ).....	10
TES-8100MC      Smart Classroom System Main Unit (19-inch rack mounting, digital infrared audio reinforcement, built-in PA, network central control, network switch, wireless IOT, paging function, IP digital audio broadcasting ).....	10
TES-8100MD      Smart Classroom System Main Unit (19-inch rack mounting, digital infrared audio reinforcement, built-in PA, network central control, network switch, wireless IOT, paging function ).....	10
<b>TES-8040 Series Control Unit</b> .....	<b>12</b>
TES-8040B      Control Unit (4.3 inch display screen, IC card, pluggable microphone stem, standard 60 cm microphone stem, 50 cm or 70 cm microphone stem optional).....	12
MS50EGD2B      Stem Microphone (50 cm, built-in windshield, dual-flex gooseneck arm, for TES-5600 series Wired Desktop Microphone and TES-8040 series Control Unit, black).....	12
MS60EGD2B      Stem Microphone (60 cm, built-in windshield, dual-flex gooseneck arm, for TES-5600 series Wired Desktop Microphone and TES-8040 series Control Unit, black).....	12
MS70EGD2B      Stem Microphone (70 cm, built-in windshield, dual-flex gooseneck arm, for TES-5600 series Wired Desktop Microphone and TES-8040 series Control Unit, black).....	12
<b>TES-5600RN Series Digital Infrared Receiver</b> .....	<b>13</b>
TES-5600RN/30      Digital Infrared Receiver (RJ45 interface, ceiling, wall or tripod-mounted, support 2 wireless microphones).....	13
<b>TES-8060 Wireless Air Conditioner Controller</b> .....	<b>14</b>
<b>TES-8061 Wireless Power Controller</b> .....	<b>14</b>
<b>TES-8062 Control Extender Kit</b> .....	<b>15</b>

<b>Accessories</b> .....	<b>15</b>
CBL2PL-01C            IR Transmission Stick (single emitter, with a 1.2 m long cable).....	15
CBL3PL-01C            IR Transmission Stick (three emitters, with a 1.2 m long cable).....	15
<b>TES-8063 Infrared Code Learner</b> .....	<b>16</b>
<b>TES-8070A Environment Monitor</b> .....	<b>16</b>

## Smart Classroom System

### System overview

With the wide application of multimedia teaching system, the traditional teaching equipment has become unable to meet the needs of campus information management. In order to further improve the teaching quality and teaching management service level, and create a convenient, intelligent and interconnected smart classroom system, TAIDEN launched TES-8100 series smart classroom system after its digital infrared wireless classroom audio system.

TES-8100 series smart classroom system integrates the digital infrared audio transmission and control technology used in the current TES-5600 series classroom audio system. At the same time, the network communication technology is used to manage and remote control the multimedia platform, projector, curtain, computer, audio and video equipment, microphone and power amplifier in the multimedia classroom, so as to create an integrated, intelligent and safe smart campus.

### System Working Principle

The core of the TAIDEN digital infrared wireless classroom audio system – dirATC (digital infrared Audio Transmitting and Control technologies) - is a new technology originated by TAIDEN. It encodes and modulates audio and data signals digitally for transmission via infrared light, achieving both multi-channel audio signals and bidirectional data transmission and control. Digitalization and wireless transmission via infrared technology are integrated to make an ideal solution for a wireless conference system. TAIDEN's infrared audio transmission and control technology (dirATC) is built on its processing chip by integrating A/D (analog/digital) conversion circuit, digital encoding/decoding circuit, digital modulator/demodulator (DQPSK), and filtering and amplification circuit.



TAIDEN TDIR04 digital infrared processing chip

### System features

#### Excellent Audio Clarity

- Crystal-clear audio everywhere within an operating range of 20 meters
  - ◆ Freq. response: main unit to main unit: 50 Hz to 20 kHz  
Microphone to main unit: 100 Hz to 20 kHz
  - ◆ SNR:  $\geq 90$  dBA
  - ◆ THD:  $\leq 0.05\%$
- Better audio acoustics protects lecturers from hoarse voice
- Clearer audio facilitates learning efficiency by helping students stay focused

#### Integrated design, supporting flexible expansion

- Software and hardware integration, modular design, supporting seamless expansion of other modules
- Based on its intelligent operating system, expand and upgrade diverse teaching applications

#### Remote intelligent control

It supports display systems such as touchscreen LED display, projection curtain / whiteboard, etc., can control their switch and lifting, support centralized monitoring and management of various electrical equipment, and support energy consumption monitoring and data acquisition

#### Intelligent wireless IOT

The system features real-time acquisition of classroom temperature and humidity, CO<sub>2</sub> concentration, PM2.5, formaldehyde and other data, and can automatically turn on/off the air conditioner according to the preset parameter range to adjust the temperature and humidity, it can intelligently control the light and the curtain, provide a comfortable teaching environment.

TAIDEN Smart Classroom Management System

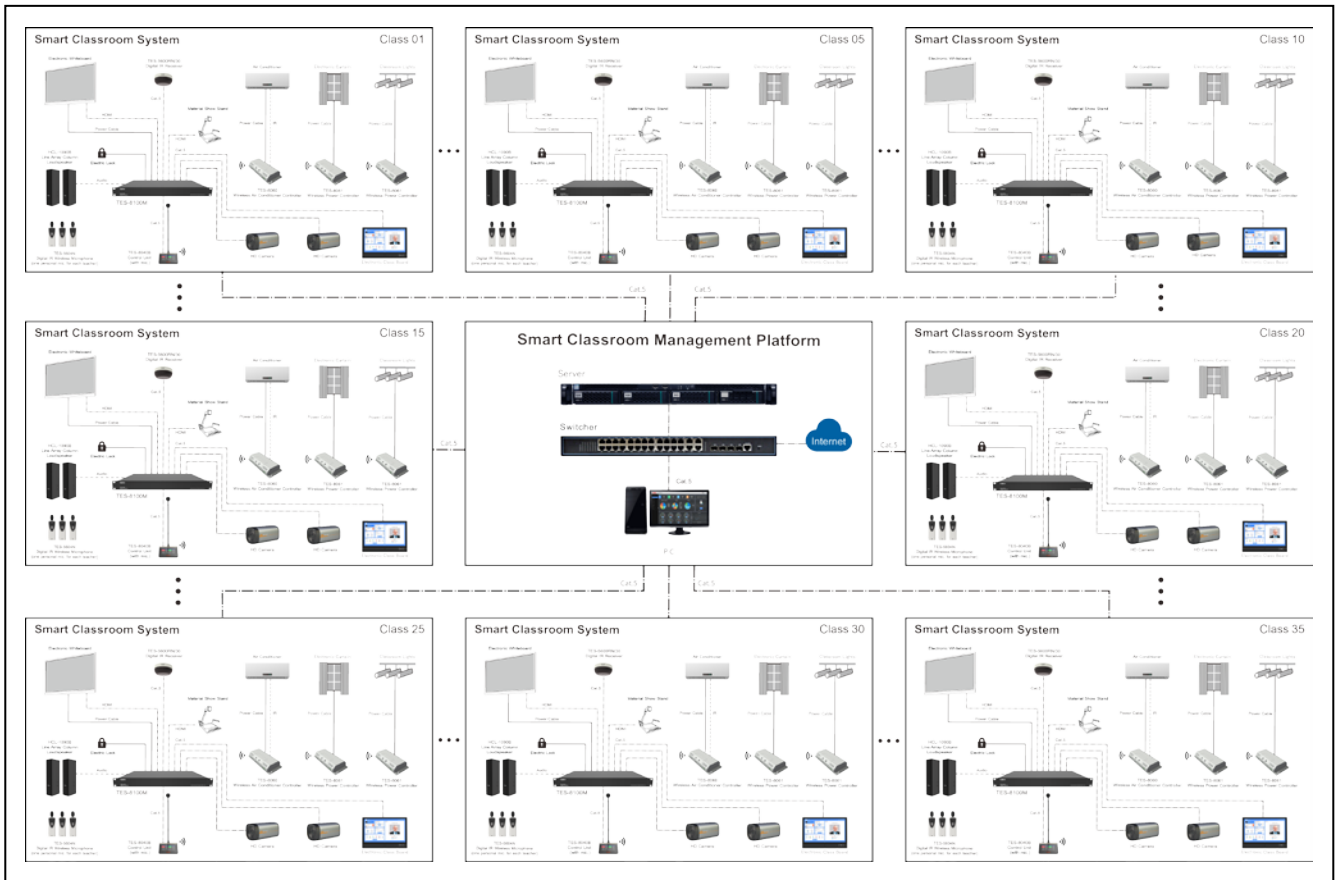



# TES-5608/20 Series Digital IR Smart Teaching Microphone



## Functions

- Original dirATC—digital infrared audio transmission and control technology
- Infrared transmitting carrier frequency conforms to IEC 61603-7, DQPSK digital modulation/demodulation technology
- Insusceptible to interferences from HF-driven lighting and works perfectly in sunlight
- Superior scalability, supporting audio input (Ø 3.5 mm AUDIO IN) from devices such as MP3 and mobile phone
- Volume adjustment of the microphone
- Remote control of PPT slides
- Supports laser pointer (TES-5608CN/20)
- Built-in digital laser pointer, with more functionalities when working with the software (TES-5608BN/20):
  - ◆ Multiple pointing modes: magnify, highlight, digital laser pointer, cross, and mouse cursor
  - ◆ Support content interaction via the cursor, such as playing video, opening links, etc.
- Transmitter powers off automatically when no voice is detected for a preset period of time
- Microphone channel adjustable
- TES-5608BN/20 and TES-5608CN/20 both have a C type USB port which can connect to and power the TES-5608AN
- TES-5608AN is a light-weight clip microphone, with an 1.5 meter USB cable for connecting to TES-5608BN/20 / TES-5608CN/20 and a clip for fitting on the lapel or necktie
- TES-5608BN/20 / TES-5608CN/20 is of ergonomically compact and elegant design, can be held in hand or hung around the neck via a nice strap or fit at the waist via a belt case
- Emission angle: vertical: 0°~ 90°, horizontal: 120°
- Emission range: linear transmitting distance: over 25 m
- Built-in rechargeable lithium battery, operation duration when microphone is continuously on about 7 hours
- Charge via C type USB port (compatible with mobile phone charger) or via charging station

## Controls and Indicators

- Power/ “...” button: Power/ select MIC/PPT mode button
- Microphone volume up/down button
- Microphone on (MIC) indicator

- PPT mode indicator
- Battery indicator
- Laser pointer button and transmitter

## Interconnections

- Ø 3.5 mm jack for auxiliary audio input
- Two charging contacts
- USB port for charging/ connecting to TES-5608AN

## Technical Specifications

### Electrical

IR transmission wavelength.....	870 nm
Modulation method.....	DQPSK
Power.....	DC 5 V, 2 A
Carrier frequency.....	Audio channel 1: 1.0 MHz
	Audio channel 2: 1.67 MHz
	Audio channel 3: 2.33 MHz
	Audio channel 4: 3.0 MHz
	Audio channel 5: 3.67MHz
Capacity of battery.....	2300 mAh
Battery Life (Mic. continuously on) .....	Approx. 7 hours

### Interface data

Connector.....	Ø 3.5 mm jack for auxiliary audio input
	USB port for charging/ connecting to microphone

### Microphone

Type.....	Uni-directional electret condenser microphone
Sensitivity.....	-46 dBV/Pa
Frequency response.....	75 Hz ~ 20 kHz
input resistance.....	680 Ω
Directivity 0°/180° .....	> 20 dB (1 kHz)
Equivalent noise .....	20 dBA (SPL)
Maximum sound pressure level.....	115 dB (THD < 3%)

### Mechanical

Color.....	dark red (TES-5608AN)
	space grey (TES-5608BN/CN)
Dimensions (h x w x d).....	47x43x14(TES-5608AN)
	41x13x123 (TES-5608BN/CN)
Weight.....	20 g (TES-5608AN)
	90 g (TES-5608BN/CN)

## Ordering Information

TES-5608AN.....	Digital Infrared Clip Microphone
TES-5608BN/20.....	Digital Infrared Wireless Presenter (space grey, with digital laser pointer, built-in rechargeable lithium battery, with neck lanyard and belt case, excl. adapter)
TES-5608CN/20.....	Digital Infrared Wireless Presenter (space grey, with laser pointer, built-in rechargeable lithium battery, with neck lanyard and belt case, excl. adapter)

## TES-1021 Clip Microphone



### Features

- Stylish and ergonomic design
- Used for TES-5604 series microphones
- Excellent immunity to RF interferences from mobile phones
- Ø 3.5 mm stereo plug with a 0.3- meter cable
- Color: black (PANTONE 419 C)
- Weight: 10 g

### Ordering Information

TES-1021..... Clip Microphone

## TES-1023 Head-worn Microphone



### Features

- Stylish and ergonomic design
- Used for TES-5604 series microphones
- Excellent immunity to RF interferences from mobile phones
- Ø 3.5 mm stereo plug with a 1.2- meter cable
- Weight: 18 g

### Ordering Information

TES-1023..... Head-worn Microphone

## TES-1022 Single-ear Microphone



### Features

- Stylish and ergonomic design
- Used for TES-5604 series microphones
- Excellent immunity to RF interferences from mobile phones
- Ø 3.5 mm stereo plug with a 0.55- meter cable
- Weight: 11 g

### Ordering Information

TES-1022..... Single-ear Microphone



## TES-5675T Hanging Microphone



### Features

- Built-in directional electret microphone to pick up the audio of the teachers' lecture
- Pickup distance: 5 m
- 1 3PIN Phoenix interface for analog audio output and power supply, can be connected to the MIC1/2 interface of main unit TES-5600MRN /MHN or TES-8100MA/MB with built-in high-performance digital signal processor (DSP) for feedback suppression (AFC), noise cancellation (ANC) and automatic gain control (AGC) function
- Highly integrated, easy to install

### Technical Specifications

#### Electrical

Microphone: .....14mm Cardioid unidirectional microphone  
 Sensitivity:..... -30 dBV/Pa  
 Frequency response:..... 50 ~ 20000 Hz  
 Directivity 0°/180° :..... > 20 dB (1 kHz)  
 Equivalent noise :..... 20 dBA (SPL)  
 Maximum sound pressure :..... 125 dB (THD<3%)  
 Phantom power requirements..... DC 11 V - 52 V, 2 mA  
 Output impedance ..... 230 Ω  
 SNR:..... ≥65.5 dBA  
 Total harmonic distortion..... ≤0.1%

#### Mechanical

Dimensions (mm) :..... Ø 124 x 53 (height)  
 Color :..... Gray  
 Weight: :..... 140 g

### Ordering Information

TES-5675T..... Hanging Microphone (Gray, round, 14mm Cardioid unidirectional microphone used to pick up the audio of the teachers' lecture)

## TES-5675S Hanging Microphone



### Features

- Built-in omnidirectional electret microphone to pick up students' interactive sounds
- Pickup range: 5 m radius with medium ambient noise  
8 m radius in a quiet environment
- 1 3PIN Phoenix interface for analog audio output and power supply, can be connected to the MIC1/2 interface of main unit TES-5600MRN /MHN or TES-8100MA/MB with built-in high-performance digital signal processor (DSP) for feedback suppression (AFC), noise cancellation (ANC) and automatic gain control (AGC) function
- Highly integrated, easy to install

### Technical Specifications

#### Electrical

Microphone: ..... Omnidirectional microphone  
 Sensitivity: ..... -32 dBV/Pa  
 Frequency response :..... 50 ~ 20000 Hz  
 Directivity 0°/180° : ..... > 20 dB (1 kHz)  
 Equivalent noise: ..... 20 dBA (SPL)  
 Maximum sound pressure: ..... 125 dB (THD<3%)  
 Phantom power supply: ..... DC 11 ~ 52 V, 2mA  
 Output impedance : ..... 230 Ω  
 SNR: ..... ≥65.5 dBA  
 Total harmonic distortion..... ≤0.1%

#### Mechanical

Dimensions (mm) :..... Ø 124 x 53 (height)  
 Color :..... Gray  
 Weight: :..... 140 g

### Ordering Information

TES-5675S..... Hanging Microphone (Gray, round, omnidirectional microphone, used to pick up students' interactive audio)

## TES-5675H Hanging Microphone



### Features

- Stylish and ergonomic design
- Built-in cardioid uni-directional electret condenser microphone to pick up the audio of the teachers' lecture
- Microphone: 14 mm cardioid unidirectional electret condenser
  - Frequency response: 50 Hz ~ 20000 Hz
  - Signal to noise ratio:  $\geq 65.5$  dBA
  - Total harmonic distortion:  $\leq 0.1\%$
  - Pickup distance: 5 m
- Super anti-interference ability of mobile phones
- Simple and rapid installation: The microphone terminal is a standard 3-pin XLR male XLRM, used for analog audio output and power supply, can be connected to any 3-pin XLRF-type socket or directly to the sound mixing console, and can also be connected to the MIC1/2 interface of main unit TES-5600MRN /MHN or TES-8100MA/MB with built-in high-performance digital signal processor (DSP) for feedback suppression (AFC), noise cancellation (ANC) and automatic gain control (AGC) function
- Low-impedance balanced audio output, the audio signal is output through the XLR male output terminal's No.2 and No.3 pins (No.2 pin is for positive phase level, No.3 pin is for negative phase level), while No.1 is Ground wire (shield) connection

### Technical Specifications

#### Electrical

Microphone: .....14mm Cardioid unidirectional microphone  
 Sensitivity:..... -32 dBV/Pa  
 Frequency response:..... 50 ~ 20000 Hz  
 Directivity 0°/180° :..... > 20 dB (1 kHz)  
 Equivalent noise :..... 20 dBA (SPL)  
 Maximum sound pressure :..... 139 dB (THD<3%)  
 Phantom power requirements.....DC 11 V - 52 V, 2 mA  
 Output impedance :..... 280  $\Omega$   
 SNR :.....  $\geq 65.5$  dBA

#### Mechanical

Dimensions (mm) :..... $\varnothing 20 \times 150$   
 Color :..... Black  
 Weight :..... 140 g

### Ordering Information

TES-5675H.....Hanging Microphone (Black, 14mm Cardioid unidirectional microphone used to pick up the audio of the teachers' lecture )



### Smart classroom connection

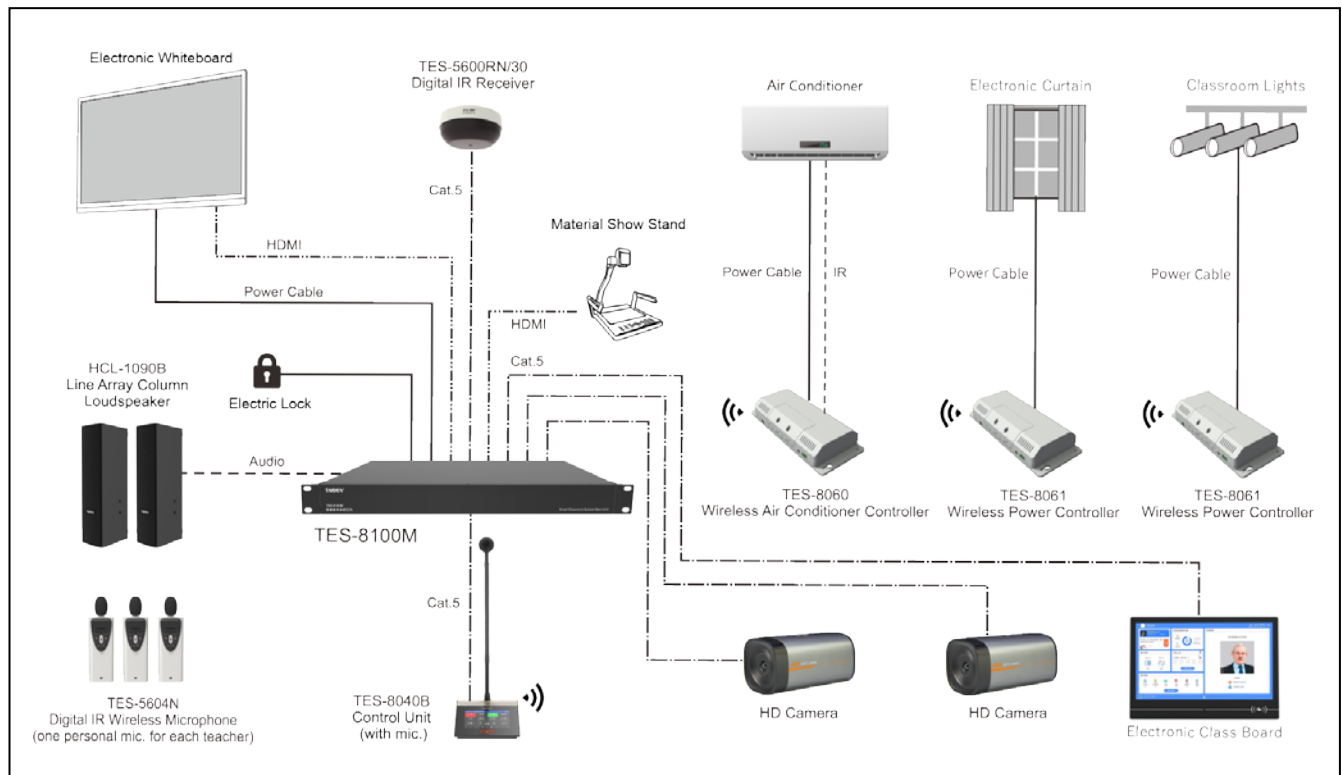

TES-8100 Series Smart Classroom System connection

Function list of TES-8100M series Smart Classroom System Main Unit

Function \ Type	TES-8100MA	TES-8100MB	TES-8100MC	TES-8100MD
Digital infrared audio reinforcement	●	●	●	●
Built-in PA	●	●	●	●
Network central control	●	●	●	●
Network switch	●	●	●	●
Wireless IOT	●	●	●	●
Paging function,	●	●	●	●
IP digital audio broadcasting,	●	●	●	
Support hanging mic.	●	●		
Remote interaction	●			

## TES-8040B Control Unit



### Ordering Information

TES-8040B.....	Control Unit (4.3 inch display screen, IC card, pluggable microphone stem, standard 60 cm microphone stem, 50 cm or 70 cm microphone optional)
----------------	--

### Functions

- Connected to TES-8100 series smart classroom system main unit for the management and control of classroom devices
- Exquisite and elegant desktop design, ergonomic and modern
- Delicate and fashionable 4.3-inch touch screen displays class information and can adjust relevant parameters. Including: starting class / dismissing class, unlocking, recording and broadcasting, volume, etc.
- Built-in speaker
- Built-in contactless IC card reader with contactless IC card slot for privilege management
- Pluggable microphone stem with selectable microphone stem length
- 1 microphone on / off button, 1 monitoring headphone jack (Ø 3.5mm )
- 1 analog audio input (Ø 3.5mm stereo, unbalanced),
- 1 analog audio output (Ø 3.5 mm, balanced)
- With a USB extension cable for PC connection
- RJ45 interface for connecting to the smart classroom system main unit
- The built-in wireless module can connect the power controller, air conditioner controller, environmental monitor and other devices in the control system

### Technical Specifications

#### Electrical

Power supply.....	24V DC
Freq. response.....	20 Hz to 20 kHz
SNR.....	Microphone: ≥ 90 dBA
.....	Earphone: ≥ 75 dBA
.....	Speaker: ≥ 65 dBA
Dynamic range.....	Mic. to main unit: ≥ 85 dB

#### Mechanical

Dimensions (h x w x d).....	44 x 135 x 132 mm
Weight.....	0.7 kg

## MS50/60/70EGD2B Stem Microphone



### Features

- Built-in windshield
- Dual-flex gooseneck tube
- Used for TES-5600 series wired desktop microphone and TES-8040 series control unit
- Stem length: 50/60/70 cm
- Color: black (PANTONE 419 C)

### Ordering Information

MS50EGD2B.....	Stem Microphone (50 cm, built-in windshield, dual-flex gooseneck arm, for TES-5600 series Wired Desktop Microphone and TES-8040 series Control Unit, black)
MS60EGD2B.....	Stem Microphone (60 cm, built-in windshield, dual-flex gooseneck arm, for TES-5600 series Wired Desktop Microphone and TES-8040 series Control Unit, black)
MS70EGD2B.....	Stem Microphone (70 cm, built-in windshield, dual-flex gooseneck arm, for TES-5600 series Wired Desktop Microphone and TES-8040 series Control Unit, black)

## TES-5600RN/30 Digital Infrared Receiver



### Functions

- World pioneering digital infrared wireless lecturing system
- Based on TAIDEN originated dirATC-digital infrared audio transmitting and control technologies
- Immune to radio and HF-driven lighting interference and work perfectly in direct sunlight
- Support 2 wireless microphones
- 1 RJ45 interface to connect CBLRJ45 Ethernet Extension Cable
- Reception angle: vertical: 150° (±75°), horizontal: 360°
- Emission range: linear transmitting distance: over 25 m  
coverage area: 80 to 100 m<sup>2</sup>

### Technical Specifications

#### Electrical

Wavelength.....	870 nm
Modulation method.....	DQPSK
Voltage.....	12 V DC (supplied from main unit or control box)

#### Mechanical

Mounting.....	Ceiling, wall or tripod mounting
Dimensions.....	60 x Ø 116 mm
Weight.....	0.2 kg
Color.....	Red (PANTONE 476)

### Ordering Information

TES-5600RN/30.....	Digital Infrared Receiver (RJ45 interface, ceiling, wall or tripod-mounted, support 2 wireless microphones)
--------------------	---

## TES-8060 Wireless Air Conditioner Controller



---

### Functions

- 1 set of power terminal for air conditioner power supply
- Connecting to the smart classroom system with built-in wireless module to realize local or remote monitoring and management
- Monitoring air conditioner power in real-time with built-in industrial class metering chip
- Infrared remote control can be realized with built-in infrared receiver module
- 2 status indicators
- Dimensions (h x w x d): 43 x 237 x 101 mm
- Weight: 0.5 kg

---

### Ordering Information

TES-8060.....Wireless Air Conditioner Controller (with 1 set power terminals, support local/remote monitoring and management, monitor air conditioner power in real-time, support infrared remote control)

## TES-8061 Wireless Power Controller



---

### Functions

- 3 sets of power terminals for supplying power to various equipment
- Connecting to the smart classroom system with built-in wireless module to realize local or remote monitoring and management
- Monitoring equipment power in real-time with built-in industrial class metering chip
- 2 status indicators
- Dimensions (h x w x d): 43 x 237 x 101 mm
- Weight: 0.5 kg

---

### Ordering Information

TES-8061.....Wireless Power Controller (with 3 sets power supply terminals, support local / remote monitoring and management, monitor equipments' power in real-time)

## TES-8062 Control Extend Kit



### Functions

- 1 RJ45 interface for connection to smart classroom system via network
- Support network control and network cascade
- LCD for displaying the device information
- 4 relay ports, 6 digital I/O ports, 4 RS232/485 ports for control classroom devices, such as projector, curtain, etc.
- 4 IR transmission ports can connect to IR transmission stick for remote control
- Dimensions (h x w x d): 45 x 190 x 78 mm
- Weight: 0.6 kg

### Ordering Information

TES-8062.....Control Extend Kit (4 relay interfaces, 6 digital I/O ports, 3 RS232/485 serial ports, 1 RS485 serial port, 4 IR ports )

## CBL3PL-01C IR Transmission Stick



### Features

Matches TES-8062 Control Extend Kit to achieve IR remote controlling for projector, DVD, PA, air conditioner, etc.

- With a 1.2-meter-long cable
- Connector: 2-PIN 3.81 mm Phoenix Connectors

### Ordering Information

CBL3PL-01C.....IR Transmission Stick (three emitters with a 1.2 m long cable)

## CBL2PL-01C IR Transmission Stick



### Features

Matches TES-8062 Control Extend Kit to achieve IR remote controlling for projector, DVD, PA, air condition, etc.

- With a 1.2-meter-long cable
- Connector: 2-PIN 3.81 mm Phoenix Connectors

### Ordering Information

CBL2PL-01C.....IR Transmission Stick (single emitter, with a 1.2 m long cable)



**TES-8063  
Infrared Code Learner**



**Functions**

- 1 Micro USB interface for connection to PC
- Built-in infrared receiver and infrared emission tube
- Cooperate with TSW-8063 infrared learning software, it can learn infrared remote control code of infrared equipments
- Dimensions (h x w x d): 25 x 20 x 76 mm
- Weight: 40 g
- Color: dark red

**Ordering Information**

TES-8063.....Infrared Code Learner  
(With TSW-8063 Infrared Learning Tool)

**TES-8070A  
Environment Monitor**



**Functions**

- Built-in sensor module can monitor indoor illumination, temperature and humidity, CO2, formaldehyde, PM2.5 / PM10 concentration , etc
- Circular curved case with ceiling-mounted or wall-mounted mounting base
- 1 RS485 (2 PIN Phoenix) for connecting to TES-8100 series smart classroom system main unit, supports standard Modbus-RTU protocol, the ModBus address and baud rate can be adjusted
- 1 power supply interface, 12V DC power supply
- Maximum power consumption: 2.4 W
- Color: White
- Dimensions: Ø 168 mm x 62 mm (height)
- Weight: 0.3 kg

**Ordering Information**

TES-8070A.....Environmental Monitor (wall-mounted or ceiling-mounted installation, RS485, 12V DC, monitor indoor illumination, temperature humidity, CO2, formaldehyde, PM2.5/PM10 concentration)

# TAIDEN®

## *Classroom Audio System*

*Excellent solutions for education*



**Installation and Operating Manual**

**V 1.7**

**Remarks:**

- All rights reserved for translation, reprint or reproduction of this document.
- Contents may change without prior announcement.
- All technical specifications are guideline data and not guaranteed features.
- TAIDEN is not responsible for any damage caused by improper use of this manual.
- The equipment must be connected to earth.
- This product conforms to the regulations of the European directive 2014/30/EU.
- To protect your hearing, please avoid high pressure level on earphones. Adjust to a lower and convenient level.
- If any detailed information needed, please contact your local retailer or **TAIDEN** service center in your region. Any feedback, advice and suggestion about the products are appreciated.
- In order to extend the life time of whole system, it is strongly recommended that the classroom audio system be scheduled to shut down every day when not in use.
- **TAIDEN** is the registered trademark of TAIDEN Industrial Co., Ltd.

# Important Safety Instructions

1. Read these instructions.
2. Keep these instructions.
3. Heed all warnings.
4. Follow all instructions.
5. The apparatus shall not be exposed to dripping or splashing and that no objects filled with liquids, such as vases, shall be placed on the apparatus.
6. The MAINS plug serving as a disconnection device should be easy to operate.
7. The apparatus should be connected to the MAINS socket-outlet with protective earth.
8. Clean only with dry cloth.
9. Do not block any ventilation openings. Install in accordance with the manufacturer's instructions.
10. Do not install near any heat sources such as radiators, heat registers, stoves, or other apparatus (including amplifiers) that produce heat.
11. Do not bypass the safety purpose of the polarized or grounding-type plug. A polarized plug has two blades with one wider than the other. A grounding type plug has two blades and a third grounding prong. The wide blade and the third prong are provided for your safety. If the provided plug does not fit into your outlet, consult an electrician for replacement of the obsolete outlet.
12. Protect the power cord from being walked on or pinched particularly at plugs, convenience receptacles, and the point where they exit from the apparatus.
13. Only use attachments/accessories specified by the manufacturer.
14. Do not leave the battery near the fire or under an environment over 60 °C (such as under direct sunlight in the car), otherwise it may damage the protection circuit of the battery and cause fire, explosion, leakage or heat generation.
15. Unplug this apparatus during lightning storms or when unused for long periods of time.
16. Refer all servicing to qualified service personnel. Servicing is required when the apparatus has been damaged in any way, such as power-supply cord or plug is damaged, liquid has been spilled or objects have fallen into the apparatus, the apparatus has been exposed to rain or moisture, does not operate normally, or has been dropped.
17. Do not place the equipment on any uneven or unstable stand; original product package or appropriate package should be used to avoid damage caused by strong impacts during transportation.
18. Power supply cords:  
AC 100 V-240 V 50 Hz/ 60 Hz
19. The quantity of connected transceivers in one system should not exceed prescribed quantity. For service, please contact the nearest TAIDEN Service Center.
20. All TAIDEN products are guaranteed for definite time (see the WARRANTY CARD for details) excluding the following cases:
  - A. All damage or malfunction caused by human negligence;
  - B. Damage or malfunction caused by improper operating by operator;
  - C. Parts damage or loss caused by disassembling the product by non-authorized personnel.
21. Use ONLY specified connection cable to connect the system equipment.
22. Upon receipt of the product, please fill out the Warranty Card enclosed and post it to TAIDEN Service Center nearby in your region.



TO REDUCE THE RISK OF ELECTRIC SHOCK, DO NOT EXPOSE THIS EQUIPMENT TO RAIN OR MOISTURE.

**CAUTION:** To reduce the risk of electric shock, DO NOT open covers, no useable serviceable parts inside. Refer servicing to qualified service personnel only.

This label appears on the rear of the unit due to space limitations



The lightning flash with an arrowhead symbol, with an equilateral triangle, is intended to alert the user to the presence of uninsulated 'dangerous voltage' within the products enclosure that may be of sufficient magnitude to constitute a risk of electric shock to persons.



The exclamation mark within an equilateral triangle is intended to alert the user to the presence of important operating and maintenance (servicing) instructions in the literature accompanying the appliance.

# Important Safety Instructions

---

**WARNING:** These apparatuses shall not be exposed to dripping or splashing and no objects filled with liquids, such as vases shall be placed on the apparatus.

**WARNING:** To reduce the risk of electric shock, DO NOT expose units to rain or moisture.



Attention: Installation should be performed by qualified service personnel only in accordance with the National Electrical or applicable local codes.



Power Disconnect: Units with or without ON – OFF switch have power supplied to the unit whenever the power cord is inserted into the power source; however, the unit is operational only when the ON – OFF switch is in the ON position. The power cord is the main power disconnect for all units

**WARNING:** The apparatus should be connected to a mains socket outlet with a protective earthing connection.

# Lithium battery safety precautions

---

To change battery please power off and take off the battery immediately.

Keep the battery away from heat sources to prevent fire or explosion.

Do not use a battery that is leaking, deformed, discolored or overheats.

Take extra precautions to keep a leaking battery from fire.

Do not use a battery that emits odor or smoke.

Do not solder, disassemble, puncture or deform the battery, otherwise, it may damage the protection circuit of the battery and cause fire, leakage or explosion.

Do not short-circuit the positive and negative electrode with wire or other metal objects, otherwise it may cause fire, explosion, leakage or heat generation.

Do not store or transport the battery with metal objects (such as necklace or hair grip), otherwise it may cause fire, explosion, leakage or heat generation.

Do not heat the battery or throw it into fire, otherwise it may damage the safety valve or the protection circuit of the battery and may cause fire or explosion.

Do not put the battery in the water or moisten the electrode of the battery, otherwise it may corrode the battery and cause fire, explosion, leakage or heat generation.

Be careful to put the battery into the charging case with correct electrode position, otherwise it may cause fire, explosion, leakage or heat generation.

Do not leave the battery near the fire or under an environment over 60 °C (such as in the car from direct sunlight), otherwise it may damage the protection circuit of the battery and cause fire, explosion, leakage or heat generation.

Please charge the battery with the dedicated base plate, using other charging unit may cause fire, explosion, leakage or heat generation.

Please use the battery in assigned unit, otherwise it may cause fire, explosion, leakage or heat generation.

Do not drop or shock the battery, otherwise it may damage the protection circuit of the battery and cause fire, explosion, leakage or heat generation.

If battery contents get into eyes it may cause blurred vision. DO NOT rub. Rinse with clear water immediately and consult a doctor.

If the battery leaks onto skin or clothing, wash the area immediately with clean water to avoid skin injury and fabric damage.

It will result in low battery and may damage the battery if the battery is not used for a long time. Please take off the battery, and fully charge the battery for every three months.

# Contents

Installation & User Guide.....	VIII
<b>Chapter 1 System introduction .....</b>	<b>1</b>
1.1 Overview.....	1
1.2 Functions and features .....	1
1.3 System technology .....	2
1.3.1 IR radiation technology.....	2
1.3.2 Carriers and channels .....	2
1.3.3 Principle of TES-5680 classroom audio system .....	2
1.4 Position planning of the digital infrared receiver .....	3
1.4.1 Position away from lighting equipment.....	3
1.4.2 Avoid direct intense light.....	3
1.4.3 Example for planning the receiver.....	3
<b>Chapter 2 TES-5680 Series Classroom Audio System .....</b>	<b>4</b>
2.1 Overview.....	4
2.2 Functions and indications .....	5
2.2.1 TES-5680M+TES-5680BX .....	5
2.2.2 TES-5685 system.....	6
2.3 Installation.....	8
2.3.1 Ceiling mounted of TES-5680M .....	8
2.3.2 Suspending mounted of TES-5680M.....	10
2.3.3 Ceiling mounted of TES-5685M .....	11
2.3.4 Suspension mounted of TES-5685M.....	12
2.4 Connection.....	13
2.4.1 Interactive audio recording system.....	13
2.4.2 TES-5685MA interactive audio recording system.....	14
2.4.3 TES-5685MB/MC digital infrared classroom audio system .....	15
2.5 Operation .....	16
2.5.1 TES-5680M+TES-5680BX .....	16
2.5.2 TES-5685M+TES-5685BX .....	21
<b>Chapter 3 TES-5600 Series Classroom Audio System .....</b>	<b>23</b>
3.1 Overview.....	23
3.2 Functions and indications .....	24
3.3 Installation.....	26
3.3.1 TES-5600RN series ceiling mounted 1 .....	26
3.3.2 TES-5600RN series ceiling mounted 2 .....	27
3.3.3 TES-5600RN series tripod-mounted .....	28
3.3.4 TES-5600RN series wall-mounted (Adjustable angle) .....	29
3.4 Connection.....	30
3.4.1 TES-5600MAU/30 .....	30
3.4.2 TES-5600MRN Series.....	31
3.4.3 TES-5600BX series.....	35

3.5 Configuration and operation .....	36
3.5.1 TES-5600MAU series.....	36
3.5.2 TES-5600MRN series .....	41
3.5.3 TES-5600BX series.....	46
3.6 USB LINK .....	47
3.6.1 Installation of USB LINK.....	47
3.6.4 Remote PPT Click Function .....	47
3.6.5 Digital Laser Pointer .....	47
3.6.2 Digital audio output.....	47
3.6.3 Digital audio input.....	48
<b>Chapter 4 TES-5690 Series Classroom Audio System .....</b>	<b>49</b>
4.1 Overview .....	49
4.2 Functions and indications .....	50
4.3 Connection.....	52
4.4 Configuration and operation .....	53
4.4.1 IR Mic Sens.....	53
4.4.2 Line Out Vol.....	53
4.4.3 Phantom Power.....	53
4.4.4 Mute by IR Mic .....	54
4.4.5 Remote Ctrl.....	54
4.4.6 Carrier Select .....	54
4.4.7 Language .....	54
4.4.8 Network .....	54
4.4.9 Auto Fade.....	54
4.4.10 FB Suppress .....	55
4.4.11 Factory Reset .....	55
4.4.12 About.....	55
4.4.13 Return .....	55
4.4.14 Protection .....	55
4.5 USB LINK .....	56
4.5.1 Installation of USB LINK.....	56
4.5.2 Remote PPT click function .....	56
3.5.3 Digital Laser Pointer .....	56
4.5.4 Digital audio input.....	57
4.5.5 Digital audio output.....	57
4.6 Webserver .....	59
<b>Chapter 5 Digital infrared wireless microphone .....</b>	<b>64</b>
5.1 Overview .....	64
5.2 Functions and indicators.....	65
5.3 Infrared light coverage .....	67
5.4 Operation .....	68
5.4.1 TES-5602A_G (handheld type) .....	68
5.4.2 TES-5604N_W .....	69
5.4.3 TES-5608N.....	71



<b>Chapter 6 Wired microphone</b> .....	<b>73</b>
6.1 Overview .....	73
6.2 Functions and indicators.....	74
6.3 Installation.....	75
6.4 Operation .....	75
<b>Chapter 7 Hanging microphone</b> .....	<b>76</b>
7.1 Overview .....	76
7.2 Functions and indicators.....	77
7.3 Installation.....	78
7.3.1 TES-5675T / TES-5675S.....	78
7.3.2 TES-5675H.....	79
<b>Chapter 8 Accessories</b> .....	<b>80</b>
8.1 Power Adapter .....	80
8.2 Dedicated Cable .....	81
8.3 Charging Station .....	81
8.4 Microphone .....	83
8.5 TES-5600ZJ2.....	83
8.6 TES-5600RZJ .....	83
8.7 MA-120P retractable hanging bar.....	84
8.8 TES-5685P Series Suspension .....	84
8.9 TES-5600M Series Cabinet Installation Accessories .....	84
8.10 TES-5604NS Neck Lanyard .....	84
8.11 Cable Splitter .....	85
8.12 Stem Microphone.....	85
8.13 Speaker .....	85
<b>Chapter 9 Technical data</b> .....	<b>88</b>
9.1 System specification .....	88
9.2 TES-5680 classroom audio system .....	89
9.3 TES-5685 series classroom audio system .....	90
9.4 TES-5600 series digital infrared wireless classroom audio system.....	91
9.5 TES-5690 classroom audio system .....	93
9.6 Digital infrared wireless microphone.....	94
9.7 Hanging microphone.....	95
9.8 Power adapter .....	95
9.9 Charging unit / microphone.....	96
9.10 Connection details .....	97
<b>Appendix</b> .....	<b>98</b>

# Installation & User Guide

---

## About this manual:

This manual is a comprehensive guide to the installation and operation of TAIDEN Classroom Audio System. It includes the detailed description of the function and interface of the classroom audio system components, system connection and installation, system set-up and operation.

## The manual is divided into the following chapters:

### **Chapter 1: System introduction**

Introduction to the classroom audio system, as well as to the structure, technical principle, and aspects of system planning.

### **Chapter 2: TES-5680 series classroom audio system**

Detailed description of functions, connection, configuration and operation of TES-5680 series classroom audio system.

### **Chapter 3: TES-5600 series classroom audio system**

Detailed description of functions, connection, configuration and operation of TES-5600 series classroom audio system.

### **Chapter 4: TES-5690 series classroom audio system**

Detailed description of functions, connection, configuration and operation of TES-5690 series classroom audio system.

### **Chapter 5: Digital infrared wireless microphone**

Detailed description of functions and operation of digital infrared wireless microphone.

### **Chapter 6: Wired microphone**

Detailed description of functions and operation of wired microphone.

### **Chapter 7: Accessories**

Detailed description of power adapter, dedicated cable, charging station, speaker, and etc.

### **Chapter 8: Technical data**

Mechanical and electrical details of classroom audio series equipments.

# Installation & User Guide

---

This manual is applicable to:

## ■ TES-5680 Series Classroom Audio System

### **TES-5680M/30**

Interactive Audio Recording System Receiver (with built-in array microphone, high performance DSP with ANC, AEC and AGC algorithm, audio localization, with digital infrared receiver, audio localization, RJ45 interface for extending receiver )

### **TES-5680BX/30**

Interactive Audio Recording System Control Box (supports 2 wireless microphones, 1 line in, 1 line out + 1 output for recording, digital audio input/output (micro USB), can connect to TES-5600 series Wired Desktop Microphone for audio transmission, built-in audio power amplifier for connection to 4 loudspeakers, with TES-ADP24V adapter)

### **TES-5685MA/30**

Interactive Audio Recording System Main Unit (with built-in array microphone, high performance DSP with ANC, AEC and AGC algorithm, audio localization, with digital infrared receiver, supports 2 wireless microphones, with analog audio input/output, output for recording, built-in audio power amplifier and integrated loudspeakers, RJ45 interface for extending receiver)

### **TES-5685MB/30**

Digital Infrared Classroom Audio System Main Unit (with digital infrared receiver, supports 2 wireless microphones, analog audio input/output, built-in audio power amplifier and integrated loudspeakers, RJ45 interface for extending receiver)

### **TES-5685MC/30**

Digital Infrared Classroom Audio System Main Unit (with digital infrared receiver, supports 1 wireless microphone,

analog audio input/output, built-in audio power amplifier and integrated loudspeakers, RJ45 interface for extending receiver)

### **TES-5685BX/20**

Function Extension Box (for TES-5685M, analog audio input/output, with 1 line in and 1 line out)

### **TES-5685BX/30**

Function Extension Box (for TES-5685M, analog audio input/output, can connect to TES-5600 series Wired Desktop Microphone for audio transmission, with 1 line in and 1 line out)

### **TES-5685BXP/30**

Function Extension Box (for TES-5685M series, analog audio input/output, can connect to TES-5600 series Wired Desktop Microphone for audio transmission, 1 line out+1 line in, 1 PA trigger)

## ■ TES-5600 Series Classroom Audio System

### **TES-5600RN1/30**

Digital Infrared Receiver (RJ45 interface, ceiling, wall or tripod-mounted, support 1 wireless microphones)

### **TES-5600RN/30**

Digital Infrared Receiver (RJ45 interface, ceiling, wall or tripod-mounted, support 2 wireless microphones)

### **TES-5600BX1/30**

Digital Infrared Classroom Audio System Control Box (with RJ45 interface, supports 1 wireless microphone, built-in audio power amplifier can be connected to 4 loudspeakers, can connect to TES-5600 series Wired Desktop Microphone for audio transmission, 2 line in, 1 line out)

# Installation & User Guide

---

## **TES-5600BX2/30**

Digital Infrared Classroom Audio System Control Box (with RJ45 interface, supports 2 wireless microphones, built-in audio power amplifier can be connected to 4 loudspeakers, can connect to TES-5600 series Wired Desktop Microphone for audio transmission, 2 line in, 1 line out)

## **TES-5600MAU/30**

Digital Infrared Classroom Audio System Main Unit (supports 2 wireless microphones, built-in amplifier, supports 4 speakers, can connect to TES-5600 series Wired Desktop Microphone for audio transmission, USB interface for digital audio input/output, phantom power, RJ45 interface to extend receiver, with adapter)

## **TES-5600MRN**

Digital Infrared Classroom Audio System Main Unit (with RJ45 interface, built-in webserver, can be setup and managed by Smart Classroom Management Platform, supports 2 wireless microphones and 2 TES-5675 Hanging microphones, built-in audio power amplifier can be connected to 4 loudspeakers, can connect to TES-5600 series Wired Desktop Microphone for audio transmission, USB interface for digital audio input/output, remote interactive features, with adapter)

## **TES-5600MHN**

Digital Infrared Classroom Audio System Main Unit (with RJ45 interface, built-in webserver, can be setup and managed by Smart Classroom Management Platform, supports 2 wireless microphones and 2 TES-5675 Hanging microphones, built-in audio power amplifier can be connected to 4 loudspeakers, can connect to TES-5600 series Wired Desktop Microphone for audio transmission, USB interface for digital audio input/output, with adapter)

## ■ **TES-5690 Series Classroom Audio System**

### **TES-5690MA**

Digital Infrared Classroom Audio System Main Unit (supports 2 wireless microphones, with DSP, built-in audio power amplifier 2x200 W+2x60 W, network control)

## **TES-5690MB**

Digital Infrared Classroom Audio System Main Unit (supports 2 wireless microphones, with DSP, built-in audio power amplifier 2x200 W, network control)

## **TES-5690MC**

Digital Infrared Classroom Audio System Main Unit (supports 2 wireless microphones, with DSP, built-in audio power amplifier 4x60 W, network control)

## ■ **Digital IR Wireless Microphone**

### **TES-5602A\_G**

Digital Infrared Wireless Microphone (handheld type, gray, with rechargeable battery, excl. adapter)

### **TES-5604N\_W**

Digital Infrared Wireless Microphone (white, built-in rechargeable lithium battery, with laser pointer, excl. adapter, used with TES-5600NS\_W neck lanyard or TES-5600CLP clip)

### **TES-5608AN**

Digital Infrared Clipper Microphone

### **TES-5608BN**

Digital Infrared Wireless Microphone Demonstrator (with digital laser pointer, built-in rechargeable lithium battery, can be used with charging base with electronic lock)

### **TES-5608CN**

Digital Infrared Wireless Microphone Demonstrator (with laser pointer, built-in rechargeable lithium battery, can be used with charging base with electronic lock)

## ■ **Wired Microphone**

### **TES-5600MIC**

Wired Desktop Microphone (standard stem microphone: 60cm, optional: 50/70cm)

# Installation & User Guide

---

## **TES-5600CSM**

Wired Desktop Microphone (standard stem microphone: 60cm, optional: 50/70cm; with a charging station for two TES-5604 series microphones, with TES- ADP5V power adapter)

## **TES-5600CSML**

Wired Desktop Microphone (standard stem microphone: 60cm, optional: 50/70cm; with a lockable charging station for one TES-5604 series microphone, can be unlocked by scanning QR code or via central control system; with TES- ADP5V power adapter)

## **TES-5600CSMN**

Wired Desktop Microphone (standard stem microphone: 60cm, optional: 50/70cm; with a lockable charging station for one TES-5604 series microphone, can be unlocked via central control system or via network management system; support network management when used with TES-5604NSW Wireless Microphones Management Platform; with TES- ADP5V power adapter)

## ■ **Charging unit**

### **TES-5600CSL**

Charging Station (with a lockable charging station for one TES-5604 series microphone, can be unlocked by scanning QR code or via central control system; with TES- ADP5V power adapter)

### **TES-5600CSN**

Charging Station (with a lockable charging station for one TES-5604 series microphone, can be unlocked via central control system or via network management system; support network management when used with TES-5604NSW Wireless Microphones Management Platform; with TES- ADP5V power adapter)

### **TES-5604CHG/01**

Charging Station (can charge one TES-5604 series microphone, excl. adapter)

### **TES-5604CHG/02**

Charging Station (can charge two TES-5604 series microphones, excl. adapter)

### **TES-5604CHG/09**

Charging Station (can charge nine TES-5604 series microphones at a time, excl. adapter)

## ■ **Microphone**

<b>TES-1021</b>	Clip Microphone
<b>TES-1022</b>	Single-ear microphone
<b>TES-1023</b>	Head-worn Microphone

## ■ **Neck Lanyard**

<b>TES-5600NS_W</b>	Neck Lanyard (adjustable length)
<b>TES-5600CLP</b>	Clip

## ■ **Power Adapter**

<b>TES-ADP5V</b>	Power Adapter (DC 5 V, 2.0 A)
<b>TES-ADP24V</b>	Power Adapter (DC 24 V, 2.7 A)
<b>TES-ADP5V6A</b>	Power Adapter (DC 5 V, 6.0 A)
<b>TES-ADP19V</b>	Power Adapter (DC 19 V, 3.42 A)

## ■ **Dedicated Cable**

### **CBLRJ45-02**

2 m Ethernet Extension Cable (with drain wire and shielded RJ45 plug)

### **CBLRJ45-05**

5 m Ethernet Extension Cable (with drain wire and shielded RJ45 plug)

### **CBLRJ45-10**

10 m Ethernet Extension Cable (with drain wire and shielded RJ45 plug)

### **CBLRJ45-20**

20 m Ethernet Extension Cable (with drain wire and shielded RJ45 plug)

### **CBLRJ45-30**

30 m Ethernet Extension Cable (with drain wire and shielded RJ45 plug)

### **CBLRJ45-40**

40 m Ethernet Extension Cable (with drain wire and shielded RJ45 plug)

### **CBLRJ45-50**

50 m Ethernet Extension Cable (with drain wire and shielded RJ45 plug)

**CBL-SPK2** Speaker Cable

**CBL-SPK** Speaker Cable

**RG-59** Coaxial-cable

**CBL-CAT5e** Cat.5e Extension Cable

# Installation & User Guide

---

## ■ Cable Splitter

### TES-0104T/30

1x4 Cable Splitter (RJ45 interface, for extending TES-5600RN/30)

### 1x2 BNC Cable Splitter

**SB-408C3** 1x4 Cable Splitter (third-party fittings)

## ■ Tripod

**TES-5600ZJ2** Microphone/Receiver Stand

**TES-5600RZJ** Fixing Bracket

## ■ Suspension

**TES-5685P-05** Suspension (0.5 m)

**TES-5685P-10** Suspension (1.0 m)

**TES-5685P-15** Suspension (1.5 m)

## ■ TES-5600M Series Cabinet Installation Accessories

**TES-5600M Cabinet Installation Accessories (single unit)**

**TES-5600M Cabinet Installation Accessories (two units)**

## ■ Stem Microphone

### MS50EGD2B

Stem Microphone (50 cm, built-in windshield, dual-flex gooseneck arm, for TES-5600 series wired Microphone)

### MS60EGD2B

Stem Microphone (60 cm, built-in windshield, dual-flex gooseneck arm, for TES-5600 series wired Microphone)

### MS70EGD2B

Stem Microphone (70 cm, built-in windshield, dual-flex gooseneck arm, for TES-5600 series wired Microphone)

## ■ Speaker

**HPA-2240** Wall Mounted Speaker (8 Ω, 40W)

### HCL-1090

Line Array Column Loudspeaker (6 Ω, 60 W, black, with adjustable installation brackets or fixed ones)

### HCL-1090B

Line Array Column Loudspeaker (6 Ω, 60 W, black, with adjustable installation brackets or fixed ones)

### HCL-1200B

Line Array Column Loudspeaker (6 Ω, 200W, black, with adjustable installation brackets or fixed ones, extra charge of USD 10 for each ceiling mount)

### HSC-106E

6.5-inch Ceiling Loudspeaker (1x6.5"+1x0.75" coaxial drive units, 16 Ω, 60 W, white)

### HSP-108E

8-inch Two-way Loudspeaker (1x8" woofer + 1x2" tweeter, gradient rotatable pointing horn, 8 Ω, 200 W, black)

### HCL-404E

4 Units Two-way Column Loudspeaker (4x4" mid-low units + 12x0.75" tweeters, 8 Ω, 200 W, 15° vertical direction, can be combined with HCL-404EJ, black)

### HCL-404EJ

4 Units Two-way Column Loudspeaker (4x4" mid-low units + 12x0.75" tweeters, 8 Ω, 200 W, 40° vertical direction, can be combined with HCL-404E, black)

# Chapter 1 System introduction

## 1.1 Overview

In 2015, TAIDEN introduced its worldwide pioneering digital infrared technology into the field of multimedia teaching and released successively a series of classroom audio systems which can be categorized as Digital IR Wireless Classroom Audio Reinforcement System, Interactive Recording and Webcasting Audio System and Lecture Recording Management Platform. The audio systems featuring excellent audio clarity, great immunity to interference and convenient management fully satisfy the need for sound reinforcement, interactive recording and webcasting, and centralized management of all the multimedia equipment in classrooms. In addition, the wireless microphone of digital IR technology provides safe and RF radiation free use. What's more, the e-lock charging station for wireless microphones frees school AV/IT teams from keeping and charging the microphones. TAIDEN Classroom Audio System includes:  
TES-5680 series Classroom Audio System  
TES-5600 series Classroom Audio System  
TES-5690 series Classroom Audio System

## 1.2 Functions and features

### 1. World leading technology

Audio transmission and control based on proprietary digital infrared processing chip (DQPSK modulation)



TAIDEN TDIR04 digital infrared processing chip

### 2. Audio clarity

CD quality audio within a range of 20 meters:

- Main unit to main unit: 50 Hz-20 kHz  
Mic. to main unit: 100 Hz-20 kHz
- SNR:  $\geq 90$  dBA
- THD:  $\leq 0.05$  %

### 3. Zero RF radiation, green and healthy

- No health hazards resulted from RF radiation
- Suitable for long-time wearing

### 4. Convenient operation and management

- Power on to talk, no frequency tuning needed
- Personal microphone for every teacher

### 5. Immunity to interference

- Allows for simultaneous use in adjacent rooms
- Insusceptible to radio and HF-driven lighting interference
- Works perfectly in direct sunlight

### 6. USB Link function

- Digital audio input/output:
  - a) lossless sound recording during class on computer;
  - b) lossless transmission of streaming audio from computer
- Cooperating with the TES-560x microphone for remote PPT-page switch control

## 1.3 System technology

### 1.3.1 IR radiation technology

The core of the TAIDEN digital infrared classroom audio system – dirATC (digital infrared Audio Transmitting and Control technologies) - is a new technology originated by TAIDEN. It encodes and modulates audio and data signals digitally for transmission via infrared light, allowing for transmission and control of both multi-channel audio signals and data by integrating A/D (analog/digital) conversion circuit, digital encoding/decoding circuit, digital modulator/demodulator (DQPSK), as well as filtering and amplification circuit.



Figure 1.1 TAIDEN digital infrared processing chip

Infrared light is part of the electro-magnetic spectrum, which is composed of visible light, radio waves and other types of waves. Its wavelength is longer than that of visible light.

Infrared light cannot pass through opaque walls and ceilings thus guarantees the privacy of the meeting by avoiding being intercepted or disturbed. In addition, infrared light generates no radio waves and a license is not required when operating infrared light systems.

### 1.3.2 Carriers and channels

TAIDEN classroom audio system adopts 1-8 MHz wave band. This wave band is suitable for the transmission of wide band audio and corresponding signals. Classroom audio system uses frequency points of BANDIV in IEC 61603 (please refer to table 1.1.)

Route	Frequency
From microphone to the digital IR wireless receiver	1.00 MHz
	1.67 MHz
	2.33 MHz
	3.00 MHz
	3.67 MHz

Table 1.1 Frequencies in classroom audio system

### 1.3.3 Principle of TES-5680 classroom audio system

TAIDEN TES-5680 classroom audio system dedicated to recording teacher's instruction and students' interaction in class by integrating digital infrared technology, DSP technology with array microphone. The system ensures broadcast level audio quality by picking up teachers' sound with IR microphone, and the sound can be separately routed to the classroom reinforcement system. An omnidirectional array microphone is used to pick up students' interactive activities; the sound will be further processed by the "3A" algorithm (ANC, AEC, AGC) and then mixed with the teacher's audio to be fed into a third-party recording system. (Figure 1.2)

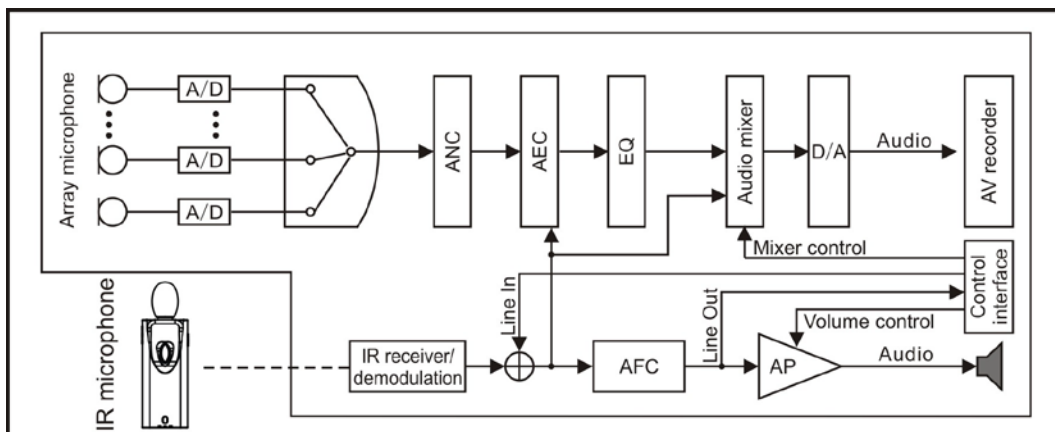

Figure 1.2 Schematic diagram of TES-5680 classroom audio system



## 1.4 Position planning of the digital infrared receiver

### 1.4.1 Position away from lighting equipment

Although TAIDEN classroom audio system has good anti-interference performance to ambient light, the distance from the receiver to lighting equipment must be at least 50 cm to guarantee adequate intensity and stability of infrared signals.

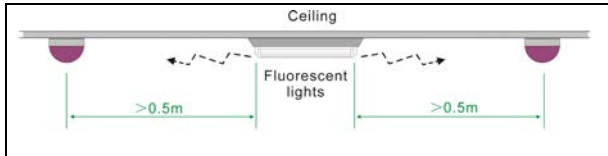

Figure 1.3 Digital infrared receiver position (near lighting equipment)

**Note:**

If the position of lighting equipment is higher than the position of the receiver, the disturbance can be ignored.

### 1.4.2 Avoid direct intense light

Exposing the receiver to intense light source may cause system failure or noise. Please do not mount the receiver in such a way the intense light source irradiates directly, as shown in follow figure:

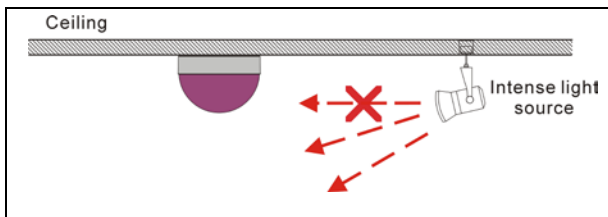

Figure 1.4 Digital infrared receiver position (avoid direct intense light)

### 1.4.3 Example for planning the receiver

The reception angle of the digital infrared receiver is 150° in vertical and 360° in horizontal. For a good reception, please plan the receiver according to the teaching environment.

#### 【8m × 8m classroom】

In an 8m × 8m classroom, one receiver can be mounted on the ceiling in the front middle part of the classroom and about 2 to 3 meters (L) away from the blackboard.

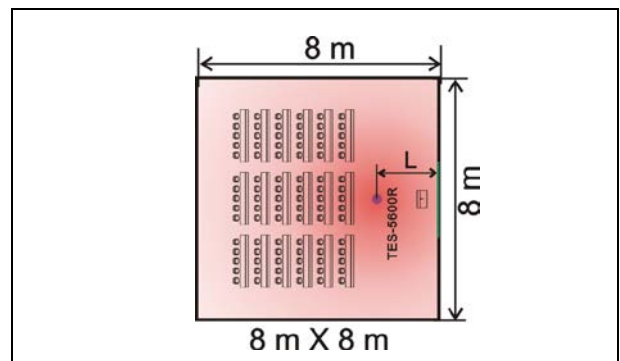

Figure 1.5 Planning the receiver 1

#### 【15m × 15m classroom】

In a 15m × 15m classroom, two receivers with a distance of 6 to 8 meters between them, can be mounted on the ceiling in the front middle part of the classroom, 2 to 3 meters (L1) away from the blackboard. And the mounting distance (L1) of TES-5685M must be more than 3 meters.

For making sure the signal is covered to the rear position, 1 or 2 receivers can be added on the ceiling, 3 or 5 meters (L2) away from the back wall in the classroom.

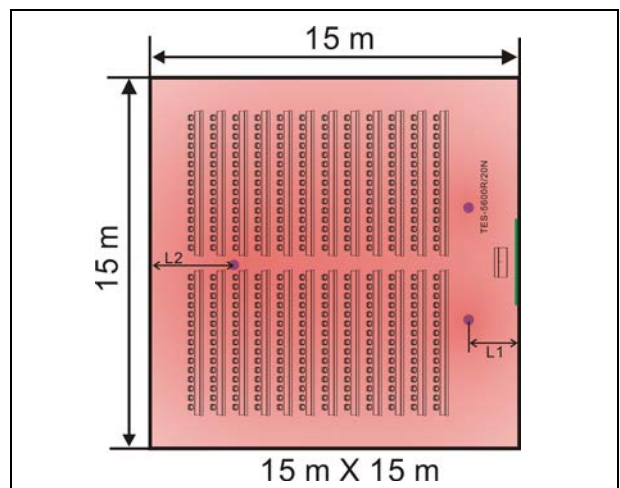

Figure 1.6 Planning the receiver 2

# Chapter 2 TES-5680 Series Classroom Audio System

## 2.1 Overview

TES-5680 series includes classroom audio system and digital infrared wireless classroom audio system.

### Types:

#### **TES-5680M/30**

Interactive Audio Recording System Receiver (with built-in array microphone, high performance DSP with ANC, AEC and AGC algorithm, audio localization, with digital infrared receiver, audio localization, RJ45 interface for extending receiver )

#### **TES-5680BX/30**

Interactive Audio Recording System Control Box (supports 2 wireless microphones, 1 line in, 1 line out + 1 output for recording, digital audio input/output (micro USB), can connect to TES-5600 series Wired Desktop Microphone for audio transmission, built-in audio power amplifier for connection to 4 loudspeakers, with TES-ADP24V adapter)

#### **TES-5685MA/30**

Interactive Audio Recording System Main Unit (with built-in array microphone, high performance DSP with ANC, AEC and AGC algorithm, audio localization, with digital infrared receiver, supports 2 wireless microphones, with analog audio input/output, output for recording, built-in audio power amplifier and integrated loudspeakers, RJ45 interface for extending receiver)

#### **TES-5685MB/30**

Digital Infrared Classroom Audio System Main Unit (with digital infrared receiver, supports 2 wireless microphones, analog audio input/output, built-in audio power amplifier and integrated loudspeakers, RJ45 interface for extending receiver)

#### **TES-5685MC/30**

Digital Infrared Classroom Audio System Main Unit (with digital infrared receiver, supports 1 wireless microphone, analog audio input/output, built-in audio power amplifier and integrated loudspeakers, RJ45 interface for extending receiver)

#### **TES-5685BX/20**

Function Extension Box (for TES-5685M, analog audio input/output, with 1 line in and 1 line out)

#### **TES-5685BX/30**

Function Extension Box (for TES-5685M, analog audio input/output, can connect to TES-5600 series Wired Desktop Microphone for audio transmission, with 1 line in and 1 line out)

#### **TES-5685BXP/30**

Function Extension Box (for TES-5685M series, analog audio input/output, can connect to TES-5600 series Wired Desktop Microphone for audio transmission, 1 line out+1 line in, 1 PA trigger)

## 2.2 Functions and indications

### 2.2.1 TES-5680M+TES-5680BX

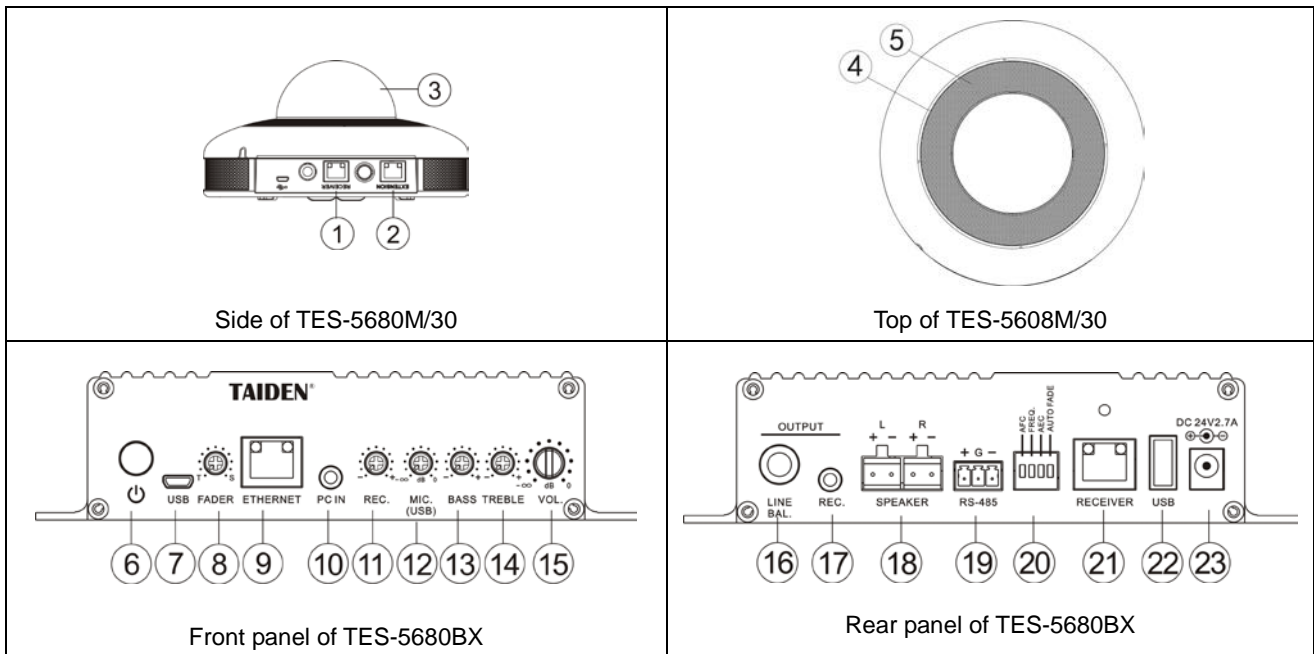

Figure 2.1 Interactive audio recording system

Figure 2.1:

#### 1. RECEIVER interfaces (RJ45)

- Connect to TES-5680BX for transmitting signals and power supply

#### 2. Receiver interface

- For connecting to TES-5600R series receiver

#### 3. IR receiver and indicator

#### 4. Microphone indicator

- Display the status of array microphone (on or standby)
- 12-segment light indicator for accurate sound direction indication

#### 5. Array microphone

#### 6. Power on/off button

#### 7. USB interface

- For firmware upgrade
- Connect to PC for remote control of PPT slides and digital audio input/output

#### 8. Fader knob

- Sound mixing ratio adjustment fader

#### 9. ETHERNET (RJ45)

- For connection to PC or central control system

#### 10. PC IN (∅ 3.5 mm)

- For audio input, the volume is 0 dB

#### 11. REC. volume knob

#### 12. MIC (connected via USB) sensitivity knob

#### 13. Bass knob

#### 14. Treble knob

#### 15. Speaker volume knob

#### 16. Line out (∅ 6.4 mm, balance)

#### 17. REC. interface (∅ 3.5 mm)

#### 18. Speaker interface

#### 19. RS-485 interface

- Connecting to central control system for adjusting the volume of IR wireless microphones

#### 20. Switch

1	AFC function
2	IR frequency
3	Communication mode (AEC)
4	Auto. fade

#### 21. RECEIVER interfaces (RJ45)

- Connect to TES-5680M for transmitting signals and power supply

#### 22. USB interface

- For connecting to TES-5600MIC and TES-5600CSM series wired microphone

#### 23. Power supply

## 2.2.2 TES-5685 system

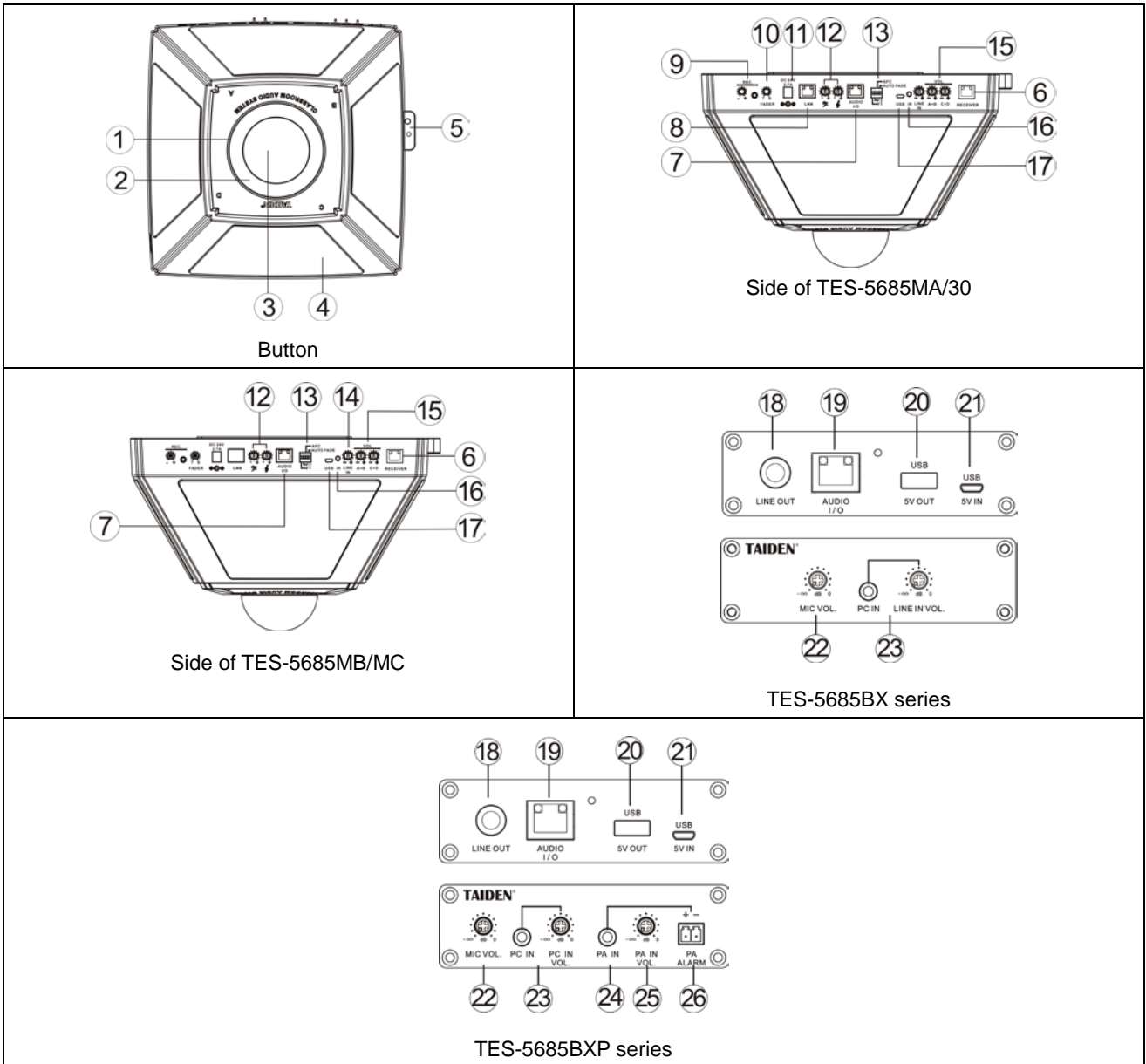

Figure 2.2 TES-5685 Series Classroom audio system

### Figure 2.2:

#### 1. Microphone indicator (only TES-5685MA)

- Display the status of array microphone (on or standby)
- 12-segment light indicator for accurate sound direction indication

#### 2. Array microphone (only TES-5685MA)

#### 3. IR receiver and indicator

#### 4. 4 Speakers (A/B/C/D)

#### 5. Hole for safety wire

#### 6. Receiver interface

- For connecting to TES-5600R series receiver

#### 7. AUDIO I/O interface (RJ45)

- Connect to TES-5685BX for transmitting audio signal

#### 8. ETHERNET (RJ45)

- For connection to Ethernet to see the system status and adjust the system parameters
- For upgrade

#### 9. REC. interface (Ø 3.5mm) and volume knob

#### 10. Fader knob

- Sound mixing ratio adjustment fader

#### 11. (reserved)

#### 12. Bass knob and treble knob

**13. Switch**

F1	IR frequency
F2	Auto. Fade/ Broadcast mode
AFC	AFC function
AUTO FADE	Auto. Fade/ Remote mode

**14. Line in volume knob**

**15. Speaker volume knob**

**16. IR indicator**

**17. USB interface**

- For firmware upgrade
- Connect to PC for remote PPT click function

**18. Line out (Ø 6.4mm, balance)**

**19. AUDIO I/O interface (RJ45)**

- Connect to TES-5685M for transmitting audio signal

**20. USB interface**

- For connecting to TES-5600MIC and TES-5600CSM series wired microphone

**21. USB interface (reserved)**

- TES-5685BX/30 without this interface

**22. Wired MIC sensitivity knob**

**23. PC IN (Ø 3.5mm) and volume knob**

**24. PA IN**

- TES-5685BXP is Ø 3.5mm interface and TES-5685PA is RCA interface

**25. PA IN volume knob**

**26. PA trigger**

- For public address system, when the PA trigger is enabled, the audio of PA IN will be routed to all the outputs with all other inputs muted

## 2.3 Installation

### 2.3.1 Ceiling mounted of TES-5680M

#### 2.3.1.1 Ceiling mounted 1

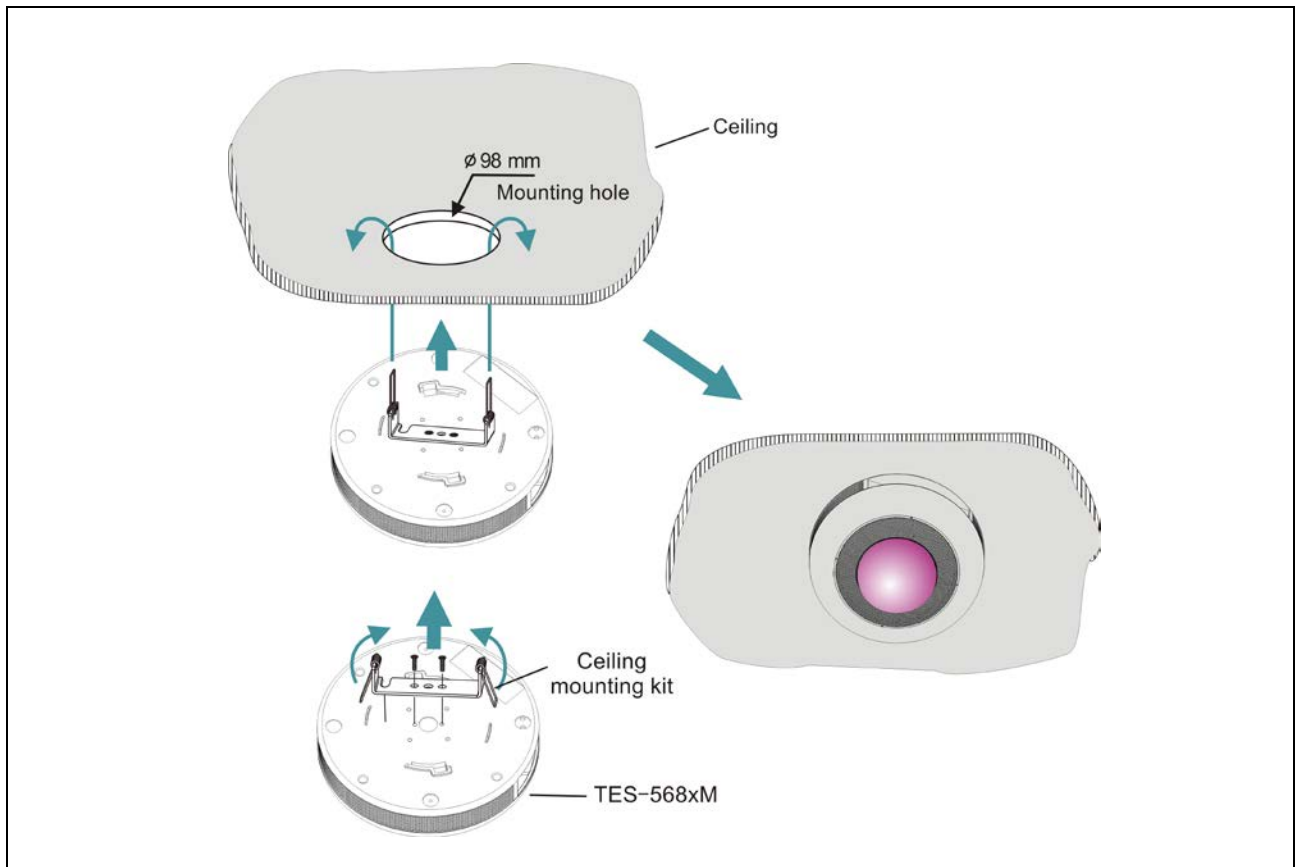

Figure 2.3 Ceiling mounted 1

#### Mounting steps:

**Step 1:** Install the ceiling mounting kit at the top of the TES-5680M;

**Step 2:** Drill a hole with 98 mm diameter into the ceiling (for mounting and heat elimination during operation);

**WARNING:**

☞ Do not cover the venting to keep good ventilation for the equipment.

**Step 3:** Hold the spring straightly and vertically, insert it into the mounting hole until the base of the TES-5680M can fit with the ceiling.

**WARNING:**

☞ The nameplate on the bottom of the TES-5680M will be covered after installation.

### 2.3.1.2 Ceiling mounted 2

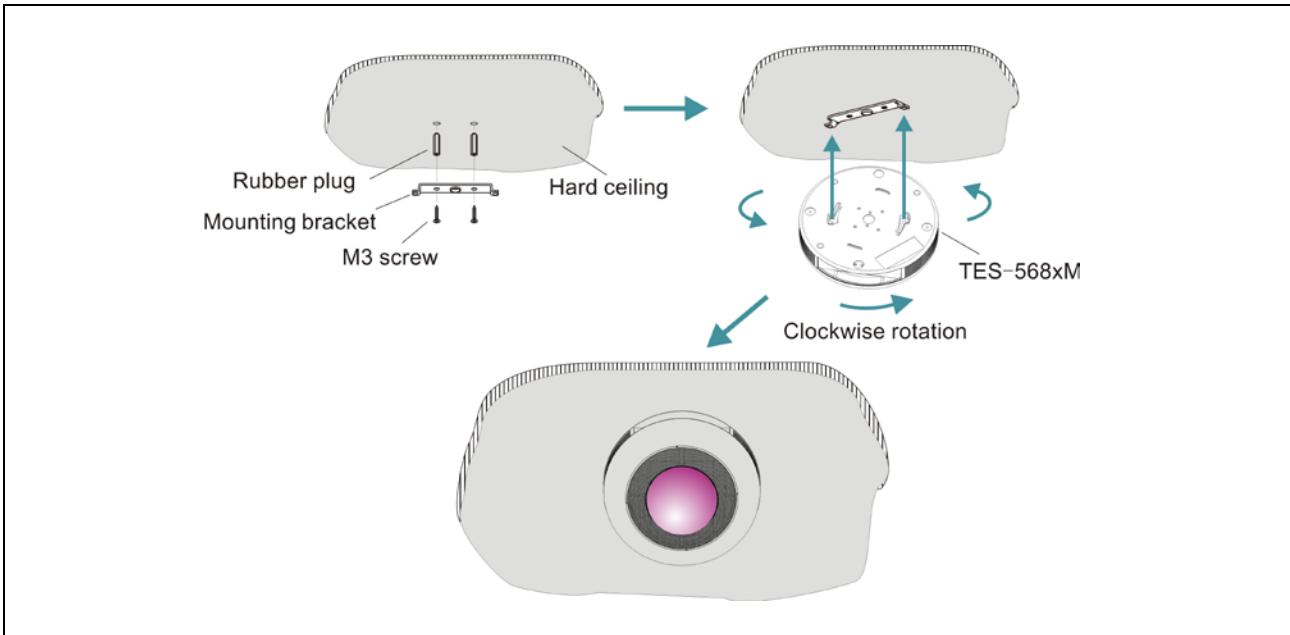

Figure 2.4 Ceiling mounted 2

#### Mounting steps:

**Step 1:** Position the mounting bracket on the ceiling according to the installation location of the TES-5680M and mark the positions of the drilling holes. Drill two holes (5 mm diameter, 30 mm depth) into the ceiling.

**Step 2:** Put the included rubber plugs into the mounting holes on the ceiling;

**Step 3:** Fix the mounting bracket on the ceiling with M3 screws;

**Step 4:** Put the slots of TES-5680M into hard ceiling mounting bracket and fix it with clockwise rotation.

#### **WARNING:**

- ☞ This installation method is applicable when the ceiling thickness is greater than the length of the rubber plug.
- ☞ The nameplate on the bottom of the TES-5680M will be covered after installation.

### 2.3.2 Suspending mounted of TES-5680M

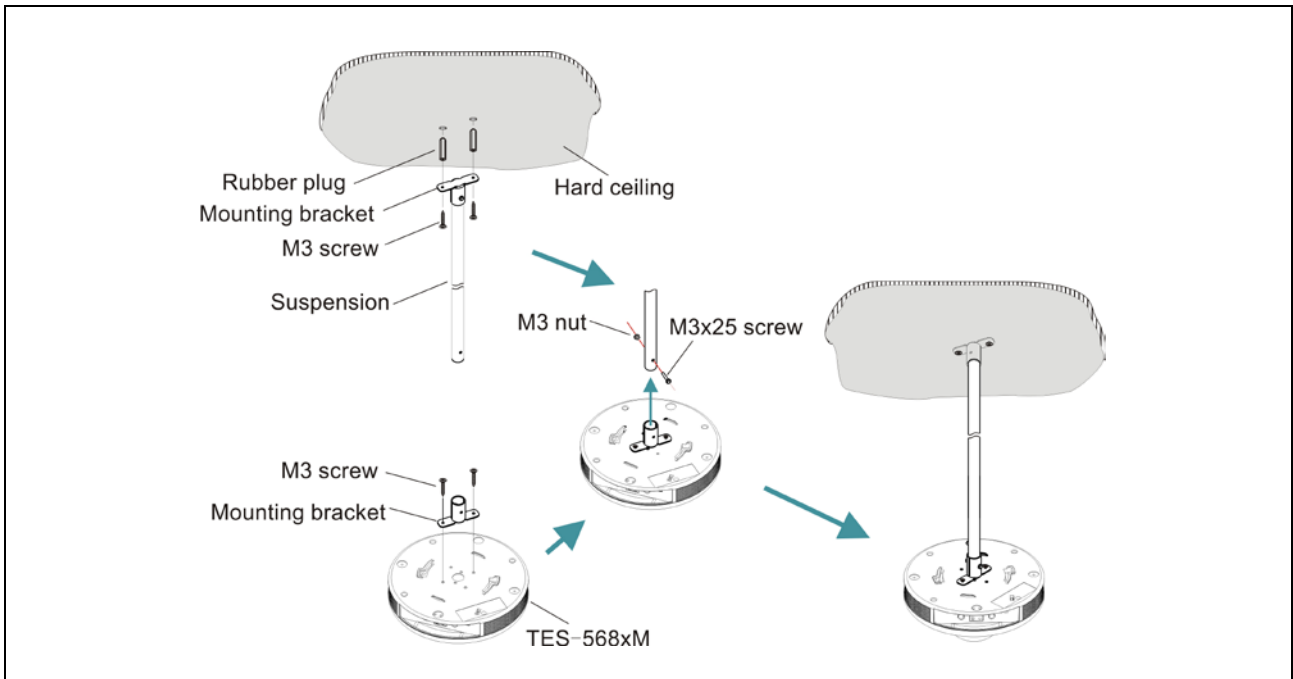

Figure 2.5 Suspending mounted

#### Mounting steps:

- Step 1:** Position the mounting bracket on the ceiling according to the installation location of the TES-5680M and mark the positions of the drilling holes. Drill two holes (5 mm diameter, 30 mm depth) into the ceiling.
- Step 2:** Put the included rubber plugs into the mounting holes on the ceiling;
- Step 3:** Fix the mounting bracket on the ceiling with M3 screws;
- Step 4:** Install the other mounting bracket at the top of the TES-5680M with M3 screws;
- Step 5:** Put the two ends of the suspension into the mounting bracket and fix them together with M3 screws and M3 nuts.

#### **WARNING:**

☞ This installation method is applicable when the ceiling thickness is greater than the length of the rubber plug.



### 2.3.3 Ceiling mounted of TES-5685M

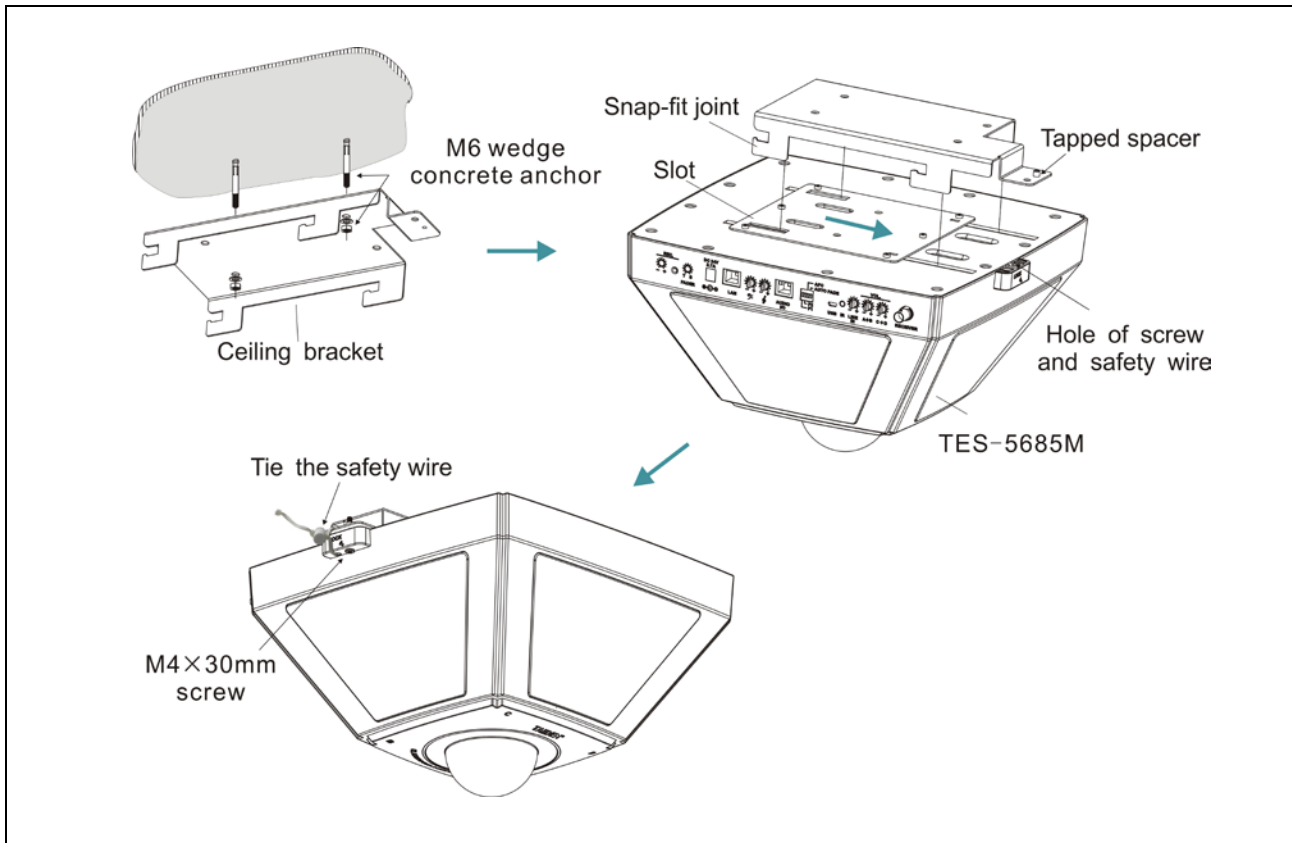

Figure 2.6 Ceiling mounted of TES-5685M

#### Mounting steps:

- Step 1:** Use the Ceiling Bracket as a template, mark 2 hole locations on the diagonal. Fix the ceiling bracket in the ceiling with M6 wedge concrete anchors;
- Step 2:** Align the slot on the top of TES-5685M to the snap-fit joint and push TES-5685M in the direction of the arrow until the tapped spacer and the screw hole are aligned;
- Step 3:** Insert the M4×30 mm screw into the tapped spacer to fix TES-5685M;
- Step 4:** Tie the safety wire.

#### **WARNING:**

☞ The nameplate on the bottom of the TES-5685M will be covered after installation.

### 2.3.4 Suspension mounted of TES-5685M

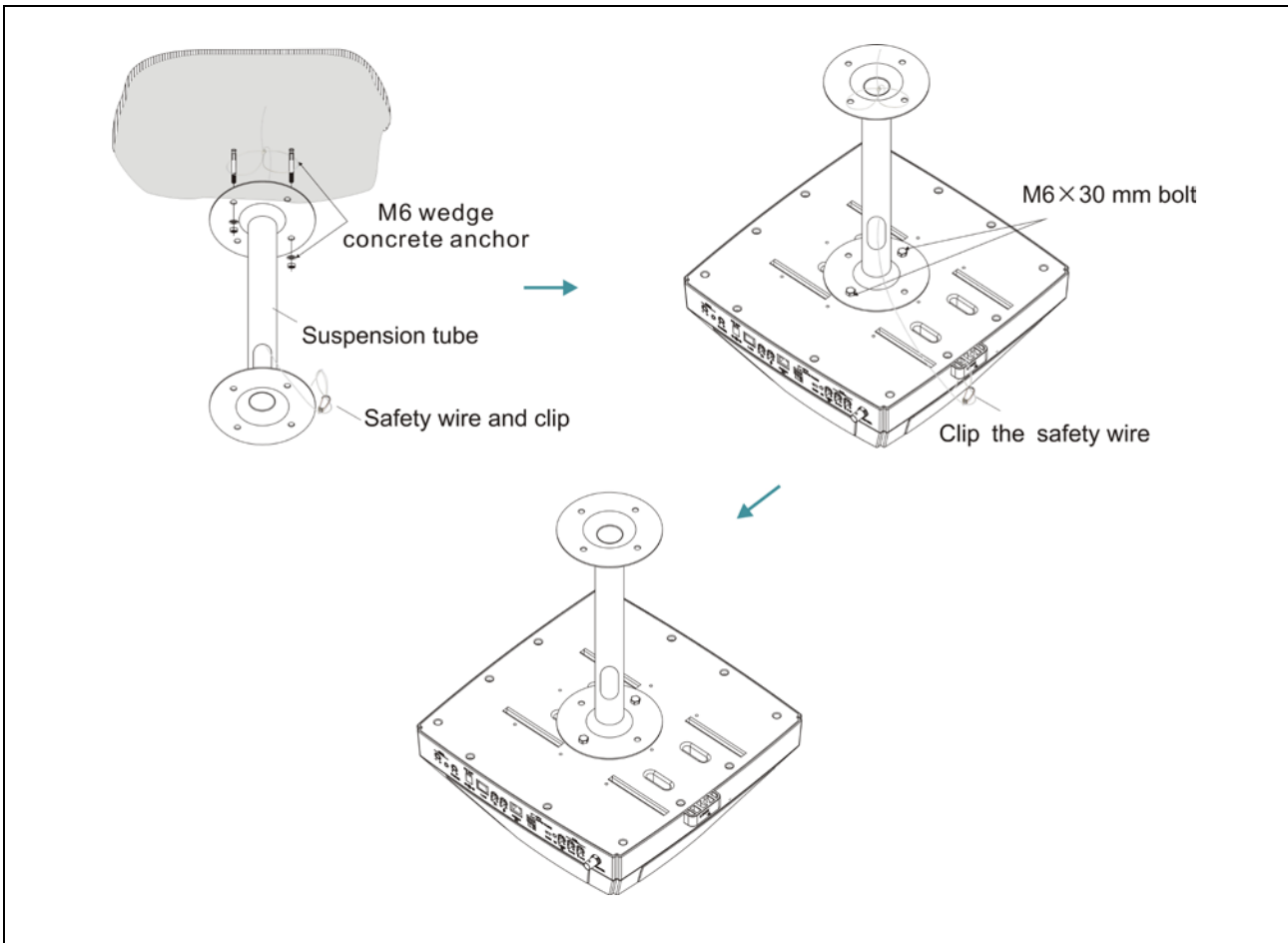

Figure 2.7 Suspension mounted of TES-5685M

#### Mounting steps:

- Step 1:** Use the suspension tube as a template to mark 2 hole locations on the diagonal. Insert M6 wedge concrete anchor into the concrete surface;
- Step 2:** Loop the safety wire around the M6 wedge concrete anchors. Route the opposite end of the safety wire through the hole on the suspension tube;
- Step 3:** Fix the suspension tube in the ceiling with the washer and nut of M6 wedge concrete anchor;
- Step 4:** Align the tapped holes on the top of TES-5685M to the mounting holes on the bottom plate of the suspension tube. Insert and fully tighten 2 M6 x 30 mm bolts;
- Step 5:** Run the safety wire through the lock hole on TES-5685M and hook it back.

## 2.4 Connection

### 2.4.1 Interactive audio recording system

Interactive audio recording system integrates digital infrared technology, DSP technology with array microphone which can realize the “3A” algorithm (ANC, AEC, AGC) and support detect the sound direction for automatic video tracking.

TES-5680M connects to TES-5680BX via RECEIVER interfaces. The system can connect to extern receiver (TES-5600RN/30 series) via Receiver interface (RJ45), connect to extern audio device via PC IN (PC) or USB

interface ( TES-5600MIC or TES-5600CSM series ) , connect to device like amplifier for output balance audio via LINE BAL, connect to recording device via REC., and connect speakers via SPEAKER (TES-5680BX).

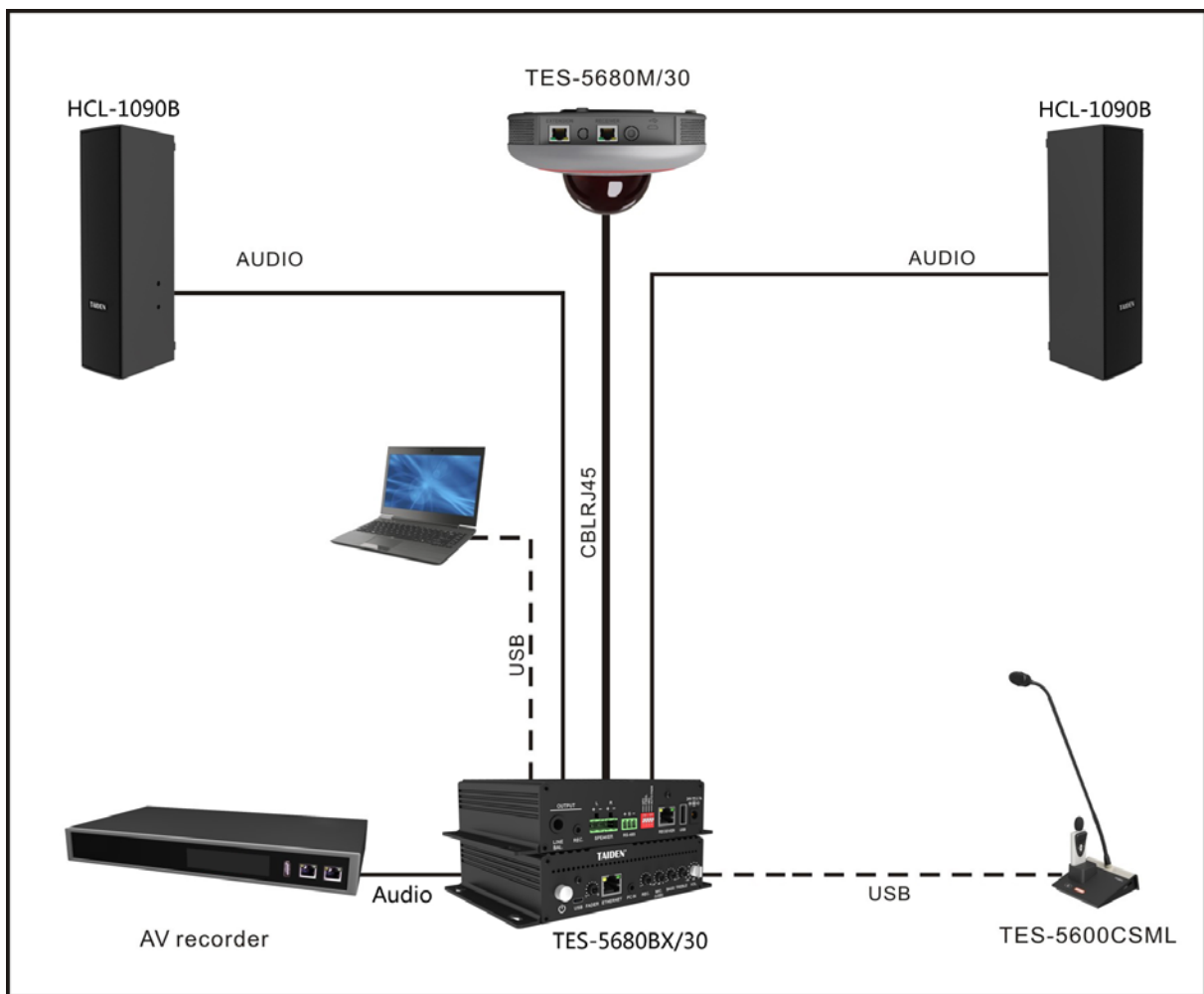

Figure 2.8 System connecting for TES-5680M+TES-5680BX

## 2.4.2 TES-5685MA interactive audio recording system

TES-5685MA Interactive Audio Recording System integrates speakers, control main unit, digital infrared receiver and amplifier, built-in DSP technology with array microphone which can realize the “3A” algorithm (ANC, AEC, AGC).

TES-5685MA connects to TES-5685BX series via AUDIO I/O interfaces. The system can connect to extern receiver (TES-5600RN/30 series) via Receiver

interface (RJ45), connect to extern audio device via PC IN (PC) or USB interface ( TES-5600MIC or TES-5600CSM series ), connect to device like amplifier for output balance audio via LINE OUT and connect to recording device via REC.

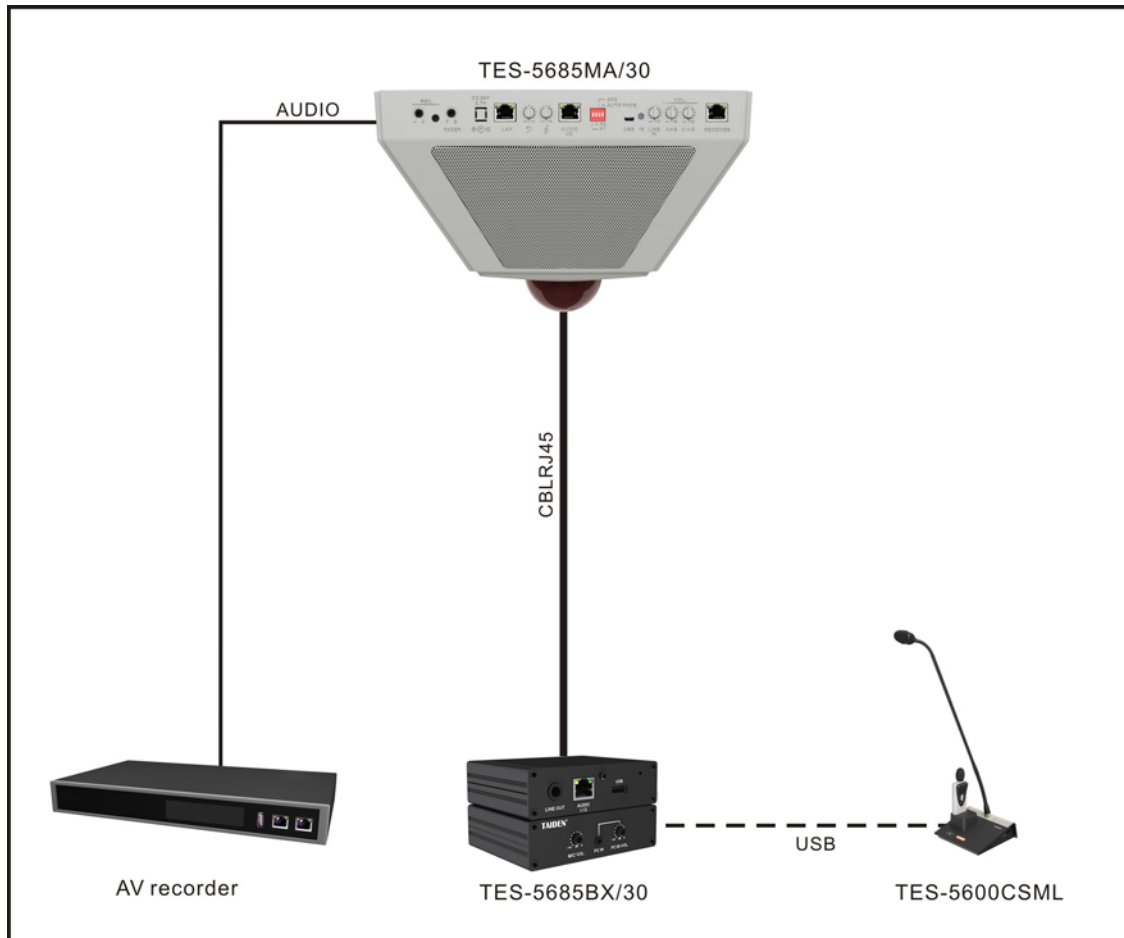

Figure 2.9 TES-5685MA interactive audio recording system

### 2.4.3 TES-5685MB/MC digital infrared classroom audio system

TES-5685MB/MC Digital Infrared Classroom Audio System integrates speakers, control main unit, digital infrared receiver and amplifier, supports 1 or 2 digital IR microphones.

TES-5685MB/MC connects to TES-5685BX series via AUDIO I/O interfaces. The system can connect to extern receiver (TES-5600RN/30 series) via Receiver

interface (RJ45), connect to extern audio device via PC IN (PC) or USB interface ( TES-5600MIC or TES-5600CSM series ) , connect to recording device via REC.



Figure 2.10 TES-5685MB digital infrared classroom audio system

## 2.5 Operation

All operation of TAIDEN Classroom Audio System will be introduced one by one in this section.

### 2.5.1 TES-5680M+TES-5680BX

#### 1. Speaker volume

Adjust the speaker via the "VOL." knob on the TES-5680BX control box.

#### 2. Treble/bass

Adjust the treble/bass of line out and speakers via the "Treble"/"Bass" knobs on the TES-5680BX control box, range: treble: -15 dB to 15 dB, bass: -12 dB to 12 dB.

**Note:**

- ☞ The bass/treble is usually adjusted only during the initial installation.

#### 3. REC. volume

Adjust the recording volume via the REC. knob on the TES-5680BX.

#### 4. External microphone in and volume

A USB interface can connect to the external microphone (TES-5600CSM series or TES-5600MIC wired microphone) and adjust the volume via MIC(USB) knob.

#### 5. IR wireless microphone volume

TES-5680BX with RS-485 interface for connecting to central control system, which can adjust the volume of IR wireless microphone via the command.

➤ **Parameter:**

Baud rate	115200
Fluid control	null
Data form	start: 1 bit, data: 8 bits, stop: 1 bit, no parity check bit

#### 6. Function switcher

Setting the function parameters via the dip switcher (switch up is 1, switch down is 0)

Function	1	0
1. AFC function	On	Off
2. IR frequency	2.33/3.67MHz	1.67/3.0MHz
3. Communication mode	PC	Recorder
4. Auto. fade	On	Off

**Note:**

- ☞ The function parameters are usually adjusted only during the initial installation.
- ☞ The IR microphone is disabled when the communication mode is PC, and the array microphone with AEC (cancel the audio of speakers), and mute the REC audio in PC IN.

#### 7. Fader rate

Adjust the fader rate between IR microphone and array microphone via the FADER knob on the TES-5680BX control box: reduce the array microphone (sound of students) until mute it with clockwise rotation and reduce the IR microphone (sound of teacher) until mute with anticlockwise rotation.

#### 8. Web server

TES-5680BX control box connects to PC via ETHERNET interface, input the IP address of Classroom Audio System (see the IP address via "TAIDEN Device Discovery" software) into web browser to search the version and set the parameters:

**TAIDEN**  
Classroom Audio System TES-5680  
System Control Panel

---

Device Version:  
TES-5680 1.0.1.4  
TES-5680BX 1.0.1.4

---

Array Mic Parameter:  
Mic Sensitivity  -30 ~ 0 dB  
Noise Suppression Level  0 ~ 5

Other Parameter:  
Enable USB Audio   
Enable CCS

Auto Duck:  
Sensitivity  -60 ~ -30 dBm  
Recovery Time  0 ~ 3 sec.

Network Setting:  
DHCP   
IP Address   
Netmask   
Gateway

➤ **Network Setting**

- Setting the IP address, netmask and gateway, reboot the device after setting. Click the DHCP can get the address automatically.

➤ **Apply:** apply the setting

- **Set Default:** click the button to default the device; user can also continuously flip the AFC DIP switch on the TES-5680BX control box twice within 5 seconds to default the device.

➤ **Device Version:** the version of current system;

➤ **Array Mic Parameter:**

- **Mic Sensitivity:** adjust the sensitivity of array microphone, range: -30 to 0 dB;
- **Noise Suppression Level:** adjust the noise reduce range (0 to 5 level) of the array microphone, the smaller the value, the more the noise but the longer the working distance, vice versa.

➤ **Other Parameter:**

- **Enable USB Audio:**

	Tick	Un checking
PPT slide	✓	✓
Digital audio input/output	✓	×
PC IN	×	✓
External microphone	×	✓

- **Enable CCS:** when clicked, user can control the digital IR wireless microphones and the speakers in the system via center control command.

➤ **Auto Dodge** (effective when the AUTO FADE switcher on the TES-5680BX control box is on):

- **Sensitivity:** adjust the trigger sensitivity of IR microphone, range: -60 to -30 dB. The array microphone will be mute after triggering.
- **Recovery Time:** setting the recovery time range (0 to 3 seconds) of the array microphone and whose sound will be recovered gradually in the set time.

## 9. USB link

Interactive audio recording system has a built-in USB LINK (2 channels, 16bit, 48kHz) which can be connected to the computer through USB cable (software requirement: Win7 or higher) for digital audio input/output. Cooperating with the TES-560x microphone can realize remote control PPT slide. In the following we take Win7 system as an example to introduce the function and operation of the USB LINK.

### (1) Connect to PC

The TES-5680BX control box connects to the computer; the TES-5680 USB LINK will be detected automatically. If it is connected for the first time, the USB device driver will be recognized and installed automatically, as shown in the following figure:

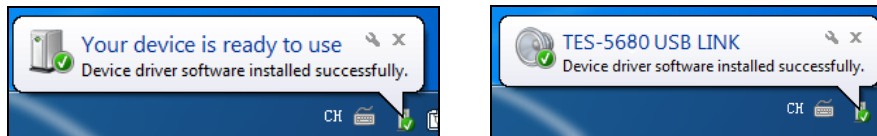

Figure 2.11 Installing USB LINK

After successful installation, the user can check the information of TES-5680 USB LINK from "Device Manager", as shown in the following figure:

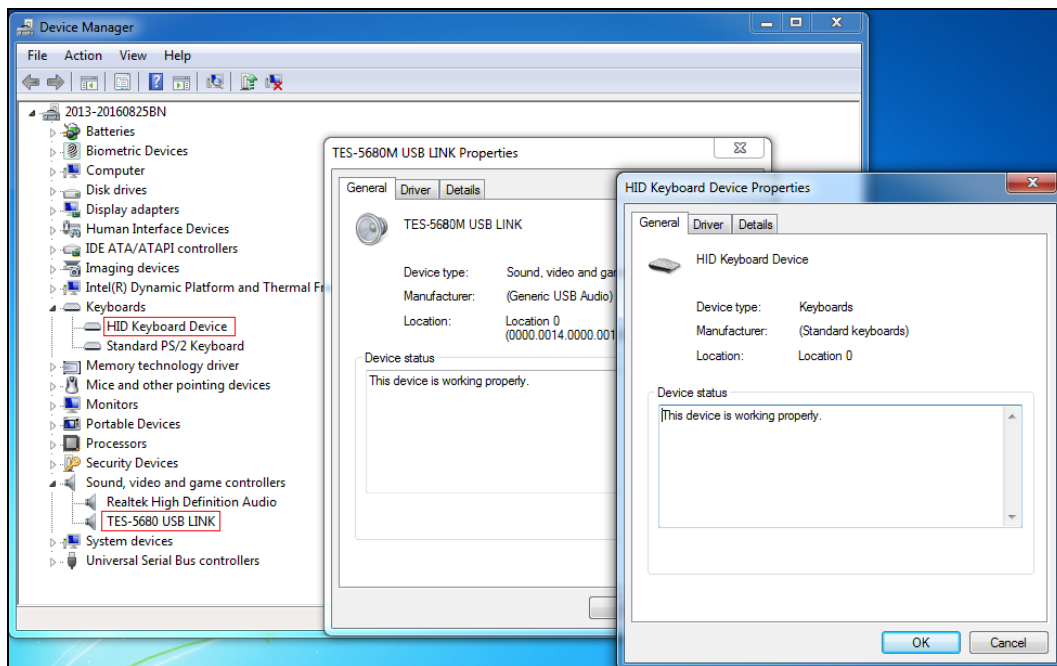

Figure 2.12 Information of USB LINK

### (2) Digital audio output

When the TES-5680BX is connected to computer with USB cable, lossless sound can be recorded during class on computer. Using the recording software or the third party communication software, such as recorder, Skype and so on, functions like recording, remote instruction, remote communication can be implemented.

Please adjust and test the TES-5680 USB LINK to a suitable volume when first using. Adjust method: open the control panel-sound (or right click the volume icon on the taskbar and select sound), and select the Microphone (TES-5680 USB LINK) and modify its setting on the Recording dialog box. Shown as the following figure:



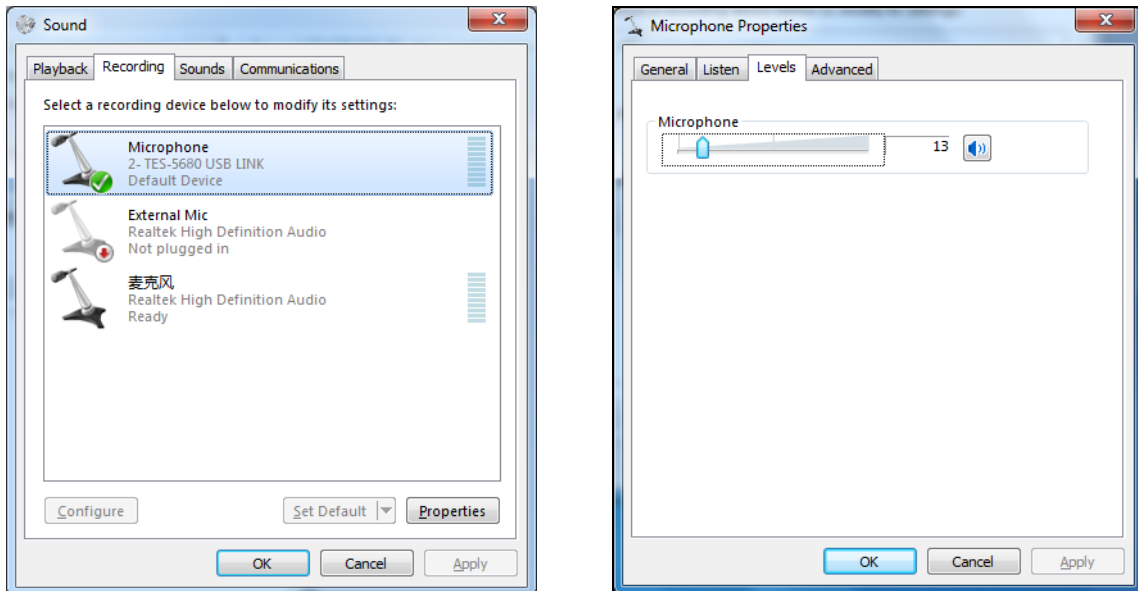

Figure 2.13 Adjusting microphone volume

**Note:**

- ☞ High volume may lead to distortion, user can confirm a suitable volume by recording and playback when necessary;
- ☞ When recording, the audio quality may be affected if using unsuitable sampling rate or resolution so it is suggested to select 48 kHz or its multiple for the sampling rate and 16 bit for the resolution;
- ☞ In "Microphone Properties- Listen", please disable "Listen to this device" (TES-5680 USB LINK) to avoid echo.
- ☞ Please select the TES-5680 USB LINK as the current device on recording or communication. Usually, TES-5680 USB LINK will be automatically activated after connecting to the computer, instead of the default audio device. If there is error in recording, please select the sound card manually in case there is a mistake in the setting.

(3) Digital audio input

The TES-5680BX can be connected to the computer for digital audio input. Please adjust and test the TES-5680 USB LINK to a suitable volume when using for the first time. Adjust method: open the control panel-sound (or right click the volume icon on the taskbar and select sound), and select the speakers (TES-5680 USB LINK) and modify its setting in the Playback dialog box, as shown in the following figure:

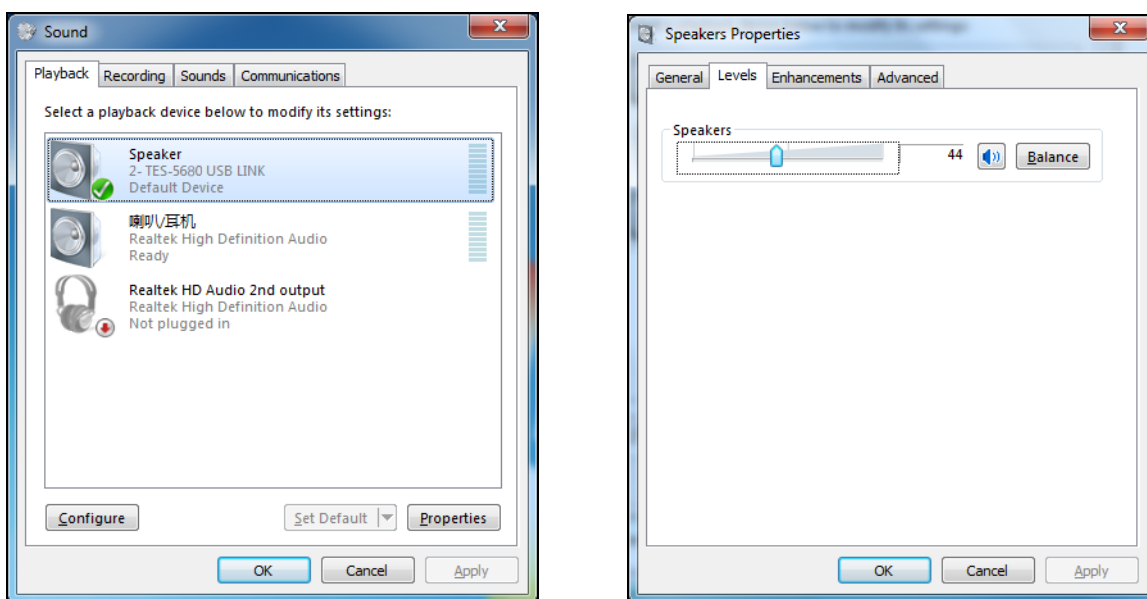

Figure 2.14 Adjusting playback volume

**Note:**

☞ Please select the TES-5680 USB LINK as the current device on playback. Usually, TES-5680 USB LINK will be activated after connecting to the computer, instead of the default audio device. If there is an error in playback, please select the TES-5680 USB LINK manually in case there is a mistake in audio device selection. Take the Media Player as an example to show the audio device selection:

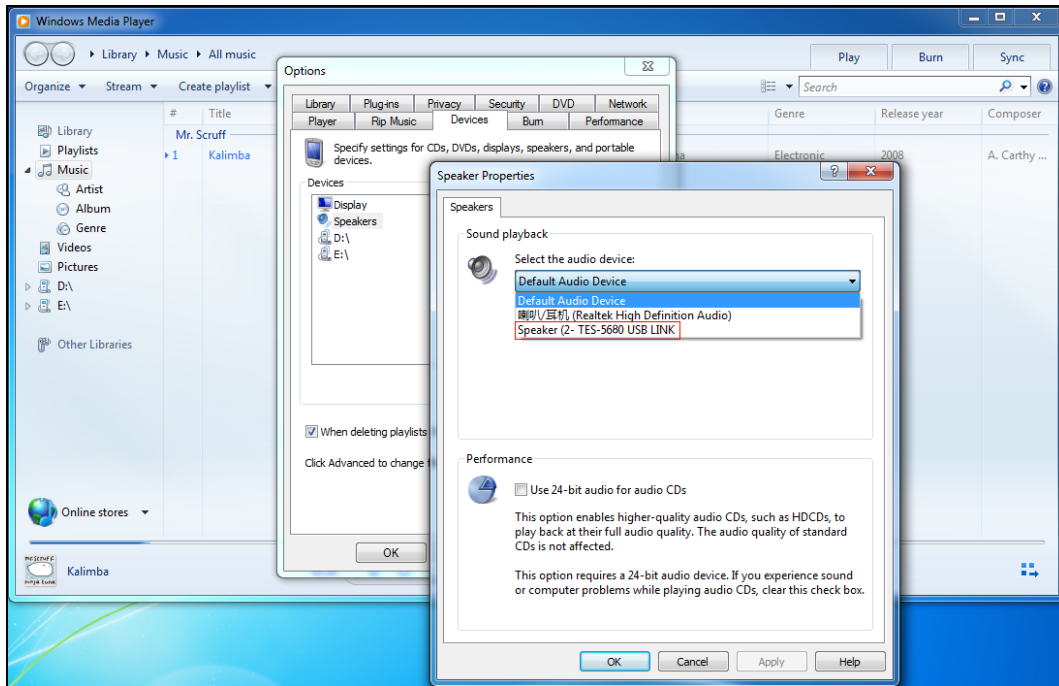

Figure 2.15 Audio device selection

(4) PPT click function

The Classroom Audio System cooperates with the TES-560x series microphone to realize remote PPT click functionl. See [5.4](#).

## 2.5.2 TES-5685M+TES-5685BX

### 1. Speaker volume

TES-5685M combo unit integrates four speakers (A/B/C/D) which be divided into 2 groups (A+B and C+D), adjust the two groups of speakers via the “VOL.” knob. Range: Mute, -30 to 0 dB.

### 2. Treble/bass

Adjust the treble/bass of line out and speakers via the “Treble”/“Bass” knobs on the TES-5685M combo unit, range: treble:

TES-5685MA: -15 dB to 15 dB, bass: -12 dB to 12 Db;

TES-5685MB/MC: -10 dB to 10 dB.

#### Note:

☞ The bass/treble is usually adjusted only during the initial installation.

### 3. External microphone in and volume

A USB interface can connect to the external microphone (TES-5600CSM series or TES-5600MIC wired microphone) and adjust the volume via MIC(USB) knob. Range: -30 to 0 dB.

### 4. Function switcher

Setting the function parameters via the switcher (switch up is 1, switch down is 0)

Function		1	0
IR frequency (F1)		TES-5685MA/MB: 2.33/3.67 MHz	TES-5685MA/MB: 1.67/3.0 MHz
		TES-5685MC: 2.33 MHz	TES-5685MC: 1.67 MHz
F2	TES-5685MA: Auto. Dodge	On	Off
	TES-5685MB/MC: Broadcast mode	On	Off
AFC function		On	Off
Auto. fade		On	Off

#### Note:

- ☞ Broadcast mode: the speakers output the signal of LINE IN, and the LINE OUT outputs the signal of microphone;
- ☞ The function parameters are usually adjusted only during the initial installation.

### 5. PPT-page switch

TES-5685MB/MC combo unit connects to PC via USB interface cooperates with the TES-560x series microphone to realize remote PPT-page switch control. See [5.4](#).

### 6. Fader rate (only for TES-5685MA)

When the Auto. Fade is off, the fader rate between IR microphone and array microphone can be adjusted via the FADER knob on the TES-5685MA combo unit: reduce the array microphone (sound of students) until mute it with clockwise rotation and reduce the IR microphone (sound of teacher) until mute with anticlockwise rotation.

### 7. Public address (only for TES-5685BXP)

TES-5685BXP control box is equipped with a PA IN for public address: when the PA trigger is enabled, the audio of PA IN will be routed to all the outputs with all other inputs muted, and the volume can be adjusted by PA IN volume knob.

### 8. Web server (only for TES-5685MA)

TES-5685MA combo unit connects to PC via LAN interface, input the IP address of Classroom Audio System (see the IP address via “TAIDEN Device Discovery” software) into web browser to search the version and set the parameters:

- **Device Version:** the version of the devices;
- **Array Mic Parameter:**
  - **Mic Sensitivity:** adjust the sensitivity of array microphone, range: -30 to 0 dB;

- **Noise Suppression Level:** adjust the noise reduce range (0 to 3 level) of the array microphone, the smaller the value, the more the noise but the farther the working distance, vice versa.
- **Auto Dodge** (effective when the AUTO FADE switcher on the TES-5680BX is on):
  - **Sensitivity:** adjust the trigger sensitivity of IR microphone, range: -60 to -30 dB. The array microphone will be mute after triggering.
  - **Recovery Time:** setting the recovery time range (0 to 3 seconds) of the array microphone and whose sound will be recovered gradually in the set time.
- **Network Setting**
  - Setting the IP address, netmask and gateway, reboot the device after setting. Click the DHCP can get the address automatically.
- **Apply:** apply the setting
- **Set Default:** default the device, user can also switch the AFC on the TES-5685BX four times in 5 seconds to default the device.

# Chapter 3 TES-5600 Series Classroom Audio System

## 3.1 Overview

TAIDEN TES-5600 series based on digital infrared technology provides an ideal audio solution for teaching environment thanks to its capabilities of anti-interference, privacy assurance, easy-manageability and audio clarity, etc.

The system consists of one digital infrared wireless main unit or control box, digital infrared receivers, and digital infrared wireless microphones. The main unit or control box have built-in amplifier which can connect up to 4 speakers.

### Types:

#### **TES-5600RN1/30**

Digital Infrared Receiver (RJ45 interface, ceiling, wall or tripod-mounted, support 1 wireless microphones)

#### **TES-5600RN/30**

Digital Infrared Receiver (RJ45 interface, ceiling, wall or tripod-mounted, support 2 wireless microphones)

#### **TES-5600BX1/30**

Digital Infrared Classroom Audio System Control Box (with RJ45 interface, supports 1 wireless microphone, built-in audio power amplifier can be connected to 4 loudspeakers, can connect to TES-5600 series Wired Desktop Microphone for audio transmission, 2 line in, 1 line out)

#### **TES-5600BX2/30**

Digital Infrared Classroom Audio System Control Box (with RJ45 interface, supports 2 wireless microphones, built-in audio power amplifier can be connected to 4 loudspeakers, can connect to TES-5600 series Wired Desktop Microphone for audio transmission, 2 line in, 1 line out)

#### **TES-5600MAU/30**

Digital Infrared Classroom Audio System Main Unit (supports 2 wireless microphones, built-in amplifier, supports 4 speakers, can connect to TES-5600 series Wired Desktop Microphone for audio transmission, USB interface for digital audio input/output, phantom power, RJ45 interface to extend receiver, with adapter)

#### **TES-5600MRN**

Digital Infrared Classroom Audio System Main Unit (with RJ45 interface, built-in webserver, can be setup and managed by Smart Classroom Management Platform, supports 2 wireless microphones and 2 TES-5675 Hanging microphones, built-in audio power amplifier can be connected to 4 loudspeakers, can connect to TES-5600 series Wired Desktop Microphone for audio transmission, USB interface for digital audio input/output, remote interactive features, with adapter)

#### **TES-5600MHN**

Digital Infrared Classroom Audio System Main Unit (with RJ45 interface, built-in webserver, can be setup and managed by Smart Classroom Management Platform, supports 2 wireless microphones and 2 TES-5675 Hanging microphones, built-in audio power amplifier can be connected to 4 loudspeakers, can connect to TES-5600 series Wired Desktop Microphone for audio transmission, USB interface for digital audio input/output, with adapter)

### 3.2 Functions and indications

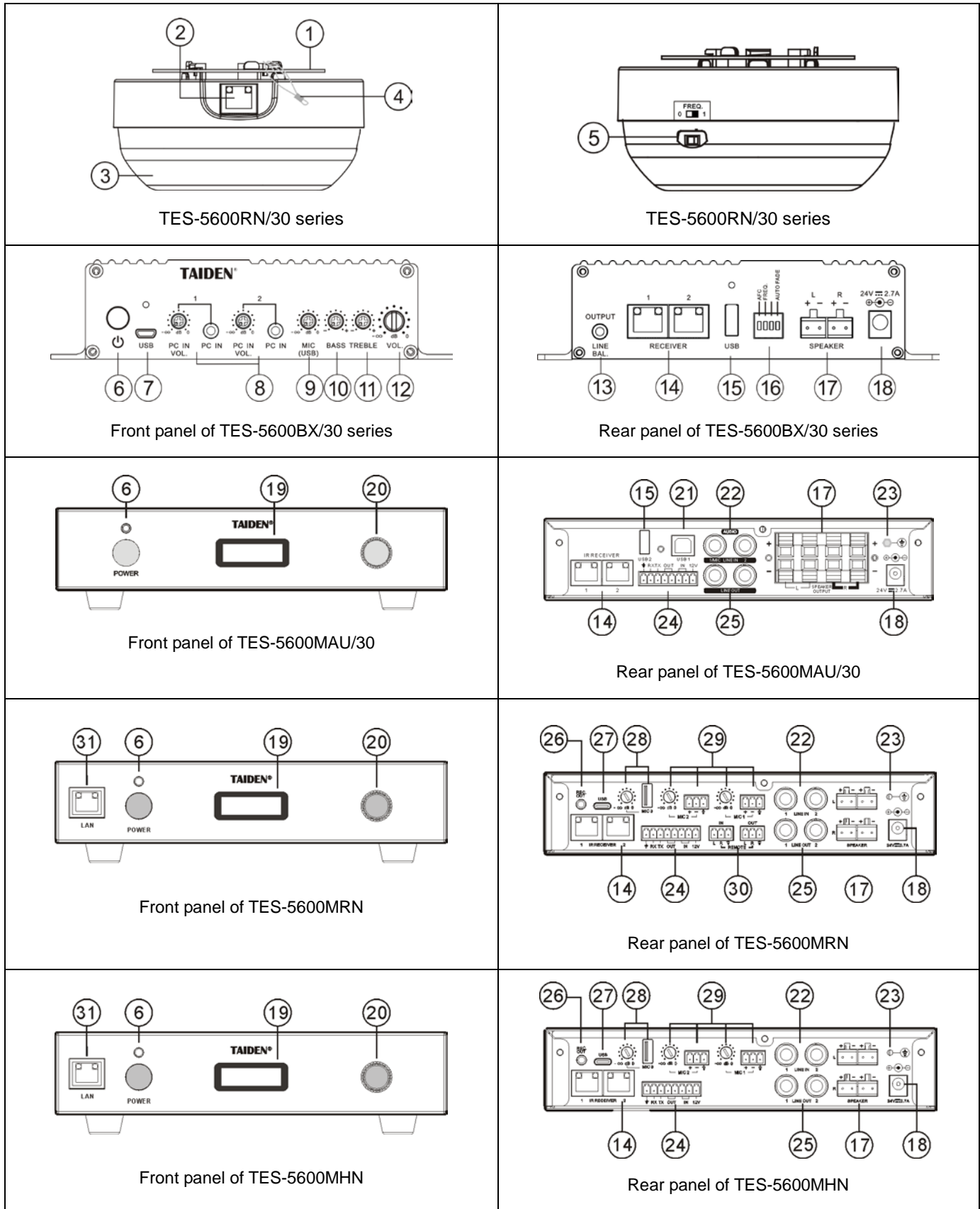

Figure 3.1 TES-5600 series classroom audio system

Figure 3.1:

**1. Fixing bracket**

**2. RJ45 interface**

**3. Infrared receiver and power indicator**

**Note:**

To guarantee smooth signal transmission, please do not block this part in any case.

**4. Safety rope, hang on fixing bracket or ceiling to prevent the receiver from falling off**

**5. FREQ. Switch**

1	2.33/3.67 MHz
0	1.67/3.0 MHz

**Note:**

Please keep the frequency the same as the main unit's.

**6. Power on/off button**

**7. Micro USB interface**

- For firmware upgrade
- Connect to PC for remote control of PPT slides

**8. PC IN (Ø 3.5 mm) and volume knob**

**9. MIC (connected via USB) sensitivity knob**

**10. Bass knob**

**11. Treble knob**

**12. Speaker volume knob**

**13. LINE BAL. (Ø 3.5 mm, balance)**

- For audio output

**14. Receiver interfaces (1-2, RJ45)**

- Connect to TES-5600RN/30 series digital IR receiver for transmitting signals

**15. A type USB interface**

- For connecting to TES-5600CSM or TES-5600MIC wired microphone for audio transmission
- For public address input

**16. Dip switch**

1	AFC function
2	IR frequency
3	Reserved
4	Auto. fade

**17. Speaker interface**

**18. Power supply interface**

**19. Menu display**

- 128×36 OLED, displays main unit status and configuration menu.

**20. Knob**

- For menu operation;
- For master volume control.

**21. B type USB interface**

- For firmware upgrade
- For digital audio input/output
- Connect to PC for remote control of PPT slides

**22. MIC/LINE IN (Ø 6.4mm, balance/differential input)**

- LINE IN 1 can offer phantom power when being used for microphone input

**23. GND**

**24. Phoenix interface**

- For connecting to central control system
- For alarm

**25. LINE OUT (Ø 6.4mm, balance/differential output)**

**26. REC. interface (Ø 3.5 mm)**

**27. C Type USB interface**

- Connect to PC for USB LINK function, supports digital audio input and output
- Connect to PC for remote control of PPT slides (with TES-560x series digital infrared microphones) and digital laser pointer function (with TES-5608BN)
- For firmware upgrade

**28. MIC3 (A Type USB interface) and volume knob**

- For connecting to TES-5600CSM or TES-5600MIC wired microphone for audio transmission

**29. MIC1/MIC2 input interface and volume knob**

- 2 × 3PIN Phoenix connector with 48V phantom power for connection to TES-5675 series hanging microphones, the sensitivity can be adjusted
- With feedback suppression (AFC)function

**30. Remote audio input and output interface**

- 2 × 3PIN Phoenix connector
- REMOTE IN: input interface for remote interactive audio signals
- REMOTE OUT: output interface for remote interactive audio signals
- With Acoustic Echo Cancellation (AEC)

**31. ETHERNET (RJ45)**

- For connection to PC, with built-in webserver
- Universal match TAIDEN Smart Classroom System Management Platform
- For connection to central control system, supports UDP control protocol

## 3.3 Installation

### 3.3.1 TES-5600RN series ceiling mounted 1

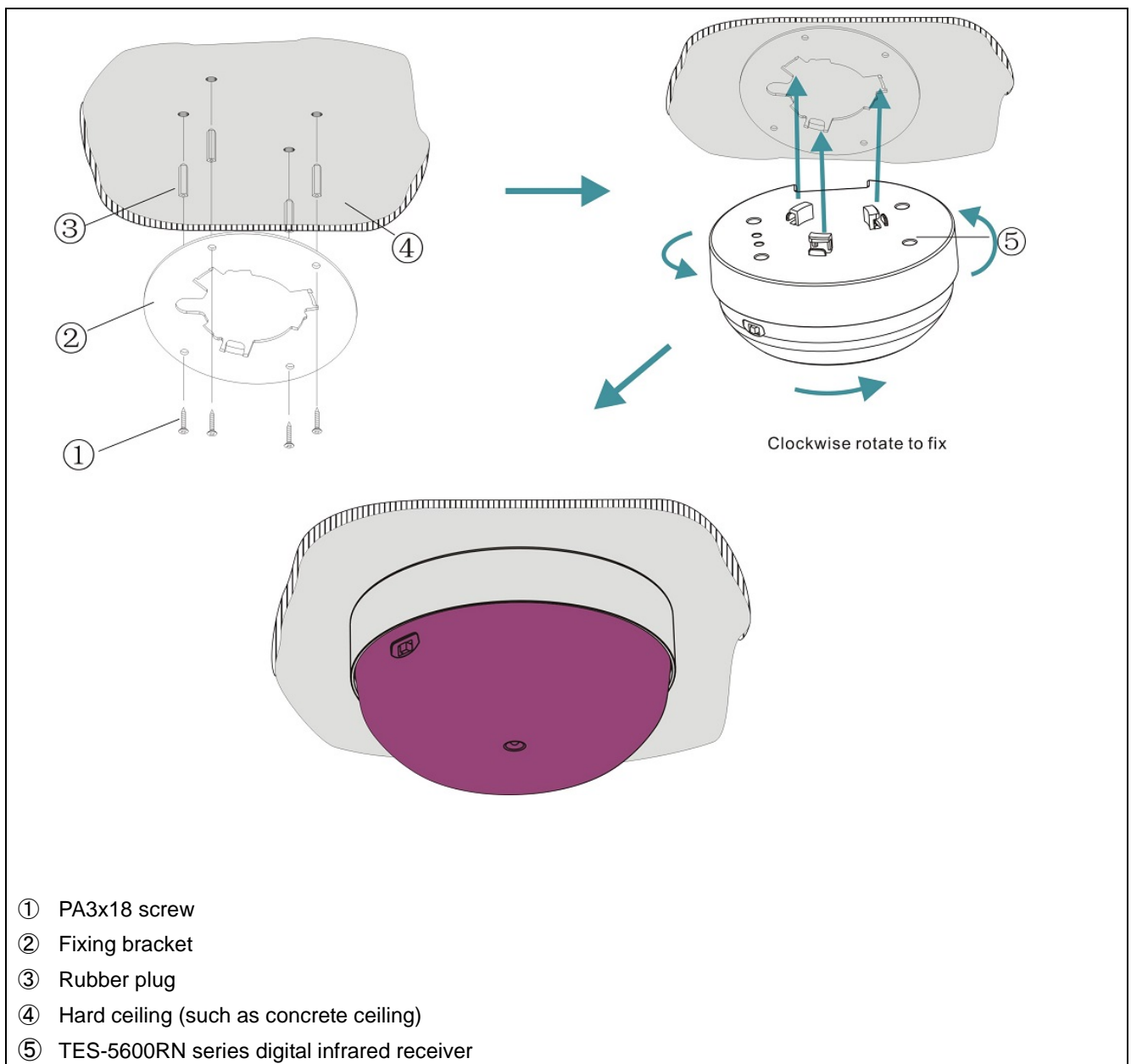

Figure 3.2 TES-5600RN digital infrared receiver ceiling mounted 1

#### Mounting steps:

**Step 1:** Position the fixing bracket on the ceiling according to the installation location of the TES-5600RN and mark the positions of the drilling holes. Drill four holes (5 mm diameter, 30 mm depth) into the ceiling;

**Step 2:** Put the rubber plugs into the mounting holes on the ceiling;

**Step 3:** Put the convex side of the bracket facing the ceiling, and fix it with M3 screws;

**Step 4:** Put the slots of TES-5600RN digital infrared receiver into hard ceiling fixing bracket and fix it with clockwise rotation.

#### **WARNING:**

☞ This installation method is applicable when the ceiling thickness is significantly greater than the length of the rubber plug.



### 3.3.2 TES-5600RN series ceiling mounted 2

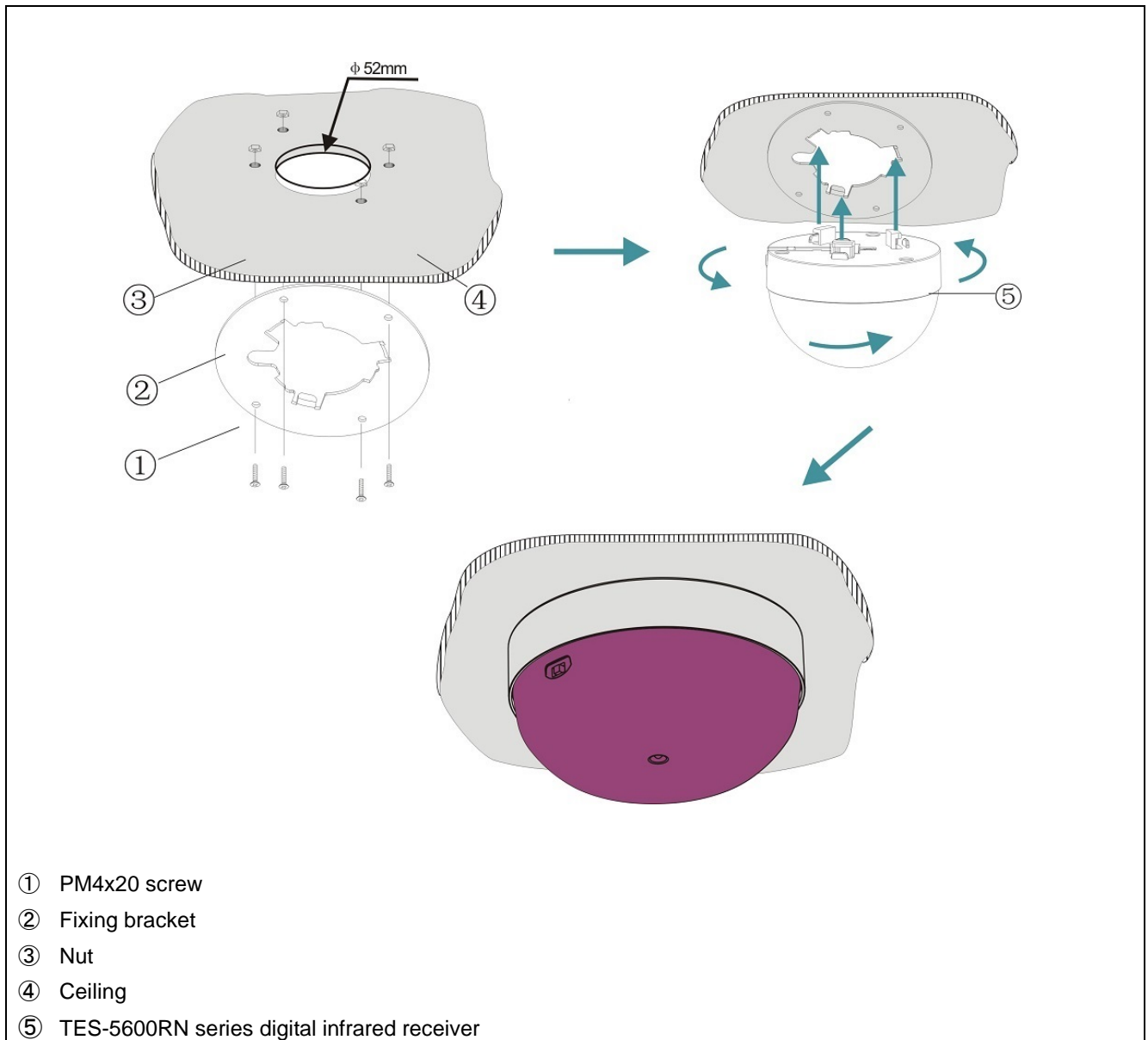

Figure 3.3 TES-5600RN digital infrared receiver ceiling mounted 2

#### Mounting steps:

**Step 1:** Position the fixing bracket on the ceiling according to the installation location of the TES-5600RN and mark the positions of the drilling holes. Drill four holes (5 mm diameter, 30 mm depth) and a vent (52 mm diameter, for mounting and heat elimination during operation) into the ceiling;

#### **WARNING:**

Do not cover the vent to keep good ventilation for the equipment.

**Step 2:** Put the convex side of the bracket facing the ceiling, and fix it with nut and M3 screws;

**Step 3:** Put the slots of TES-5600RN digital infrared receiver into hard ceiling fixing bracket and fix it with clockwise rotation.

### 3.3.3 TES-5600RN series tripod-mounted

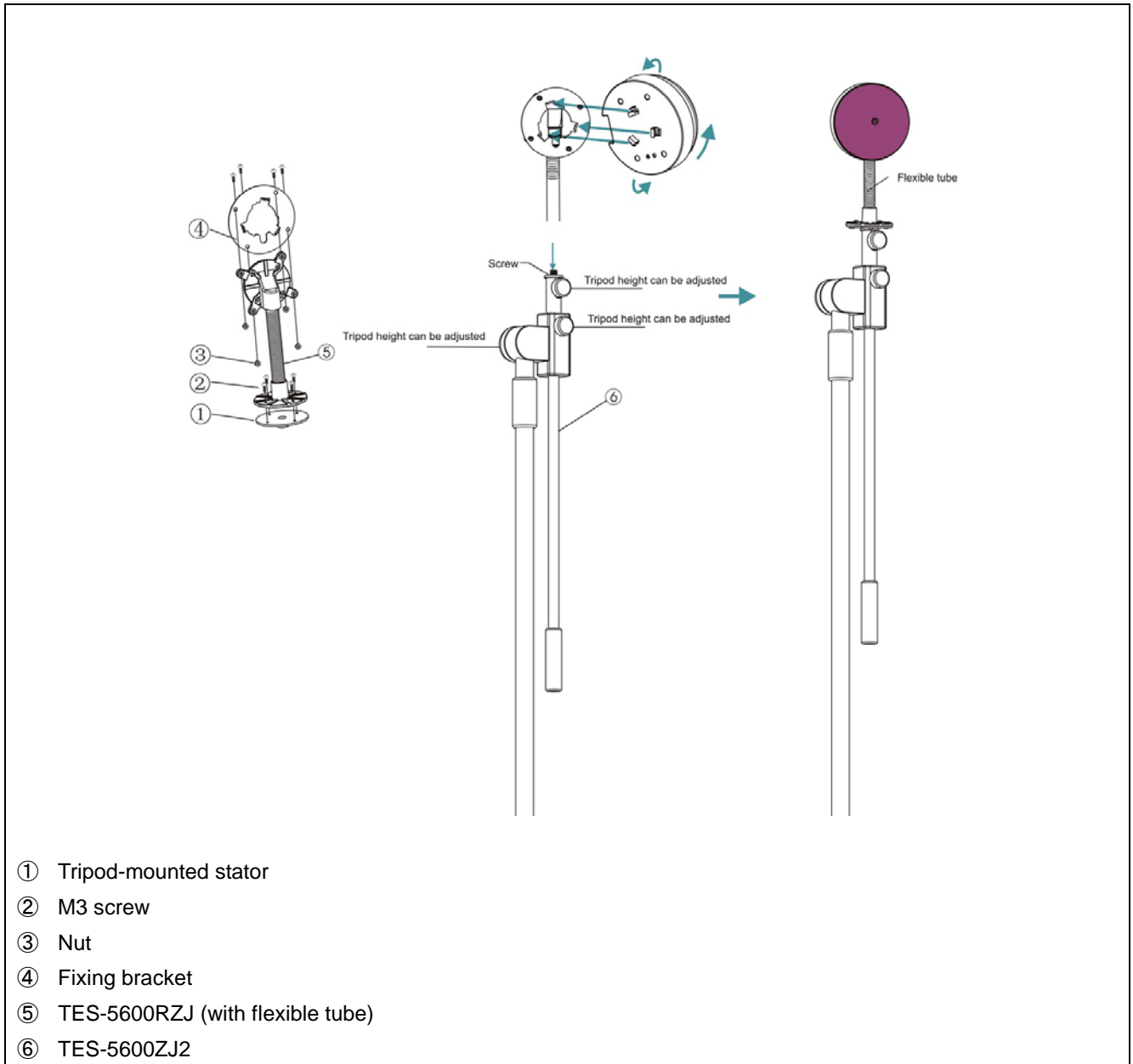

Figure 3.4 TES-5600RN digital infrared receiver tripod mounted

#### Mounting steps:

**Step 1:** Fix the fixing bracket onto the TES-5600RZJ with M3 screws;

**Step 2:** Fix the tripod-mounted stator onto the other end of the TES-5600RZJ with M3 screws;

**Step 3:** Aim the mounting hole at the bottom of the tripod-mounted stator to the screw on the tripod and then fix it with clockwise rotation;

**Step 4:** Put the slots of TES-5600RN digital infrared receiver into the fixing bracket and fix it with clockwise rotation.

### 3.3.4 TES-5600RN series wall-mounted (Adjustable angle)

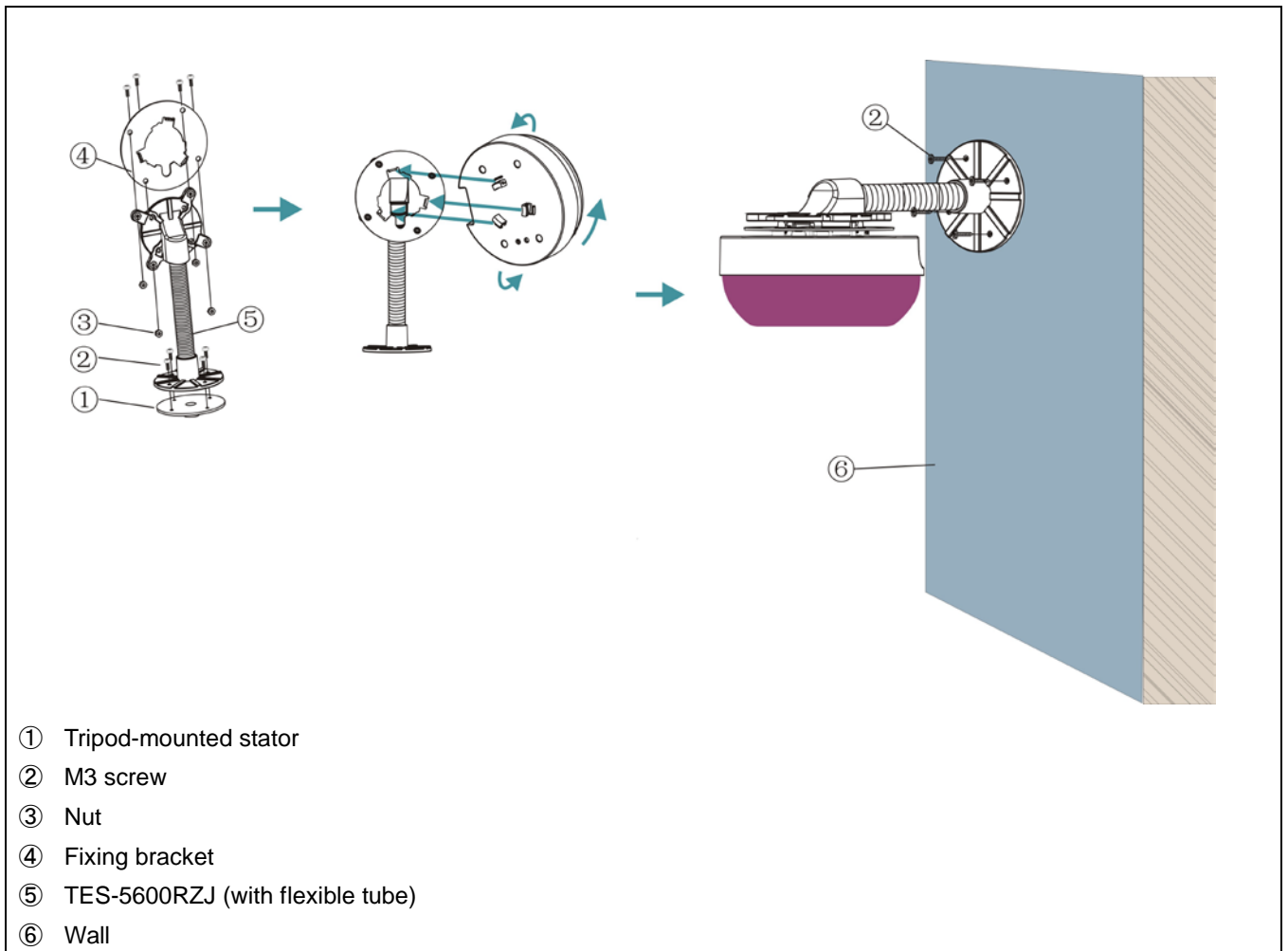

Figure 3.5 TES-5600RN digital infrared receiver tripod mounted

#### Mounting steps:

**Step 1:** Fix the fixing bracket onto the TES-5600RZJ with M3 screws;

**Step 2:** Put the slots of TES-5600R digital infrared receiver into the fixing bracket and fix it with clockwise rotation;

**Step 3:** Position the wall-mounted bracket on the wall according to the installation location of the TES-5600RN and mark the positions of the drilling holes. Drill four holes (5 mm diameter, 30 mm depth) on the wall;

**Step 4:** Put the included rubber plugs into the mounting holes on the wall;

**Step 5:** Fix the TES-5600RZJ onto the wall with M3 screws.

#### **WARNING:**

- ☞ This installation method is applicable when the wall thickness significantly is greater than the length of the rubber plug.

### 3.4 Connection

#### 3.4.1 TES-5600MAU/30

TES-5600MAU/30 has the functions of microphone controlling and volume adjusting.

TES-5600MAU/30 series connects to TES-5600RN/30 series via RECEIVER interfaces, and external audio can be fed via LINE IN, and TES-5600CSM series or TES-5600MIC wired microphone can connect to the A type USB interface for audio transmission, audio output to external device (such as recorder) via LINE OUT, and speakers connection via SPEAKER OUTPUT.

Also, TAIDEN TES-5600MAU/30 digital infrared wireless classroom audio system and TAIDEN HCS-6100

intelligent central control system can be joined together seamlessly, connecting various devices, hardware and environment equipment from different manufacturers together. The central control system can operate the teaching devices through wired Ethernet or wireless communication by wired/wireless touch panel. Features include power controlling, system PA volume controlling and controlling of various electric devices, such as DVD, recorder, etc. RS-232C interface is available.

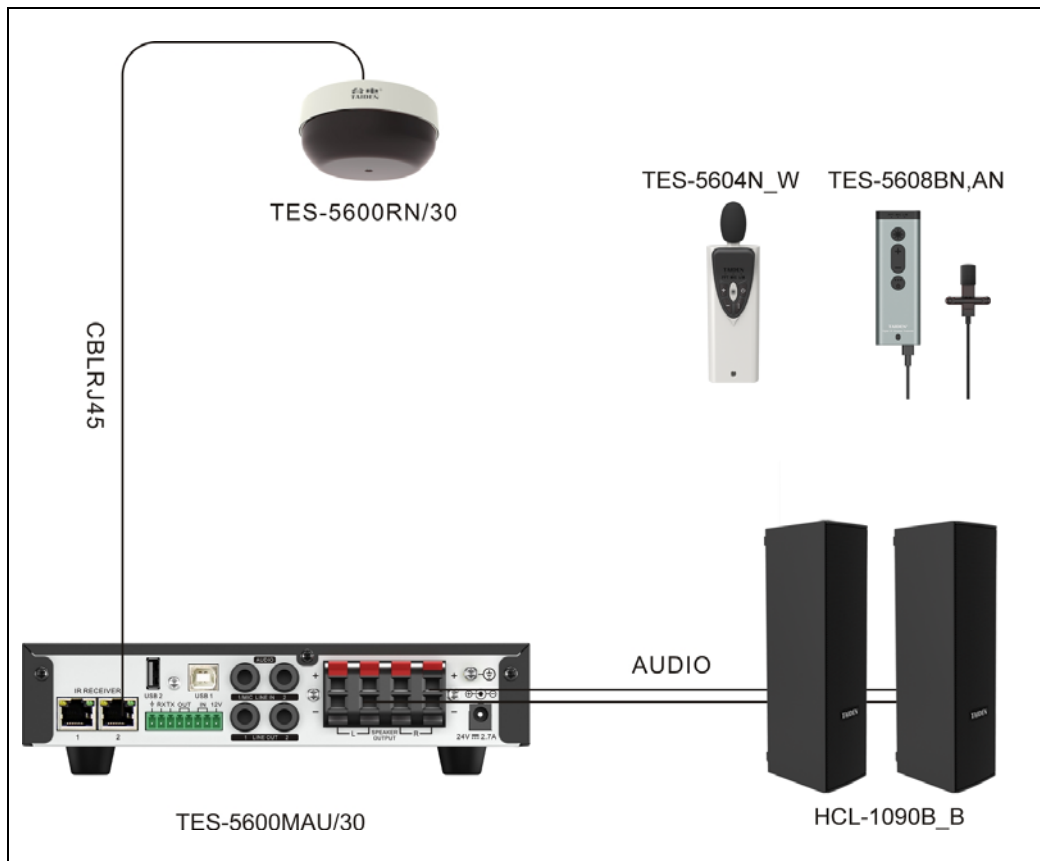

Figure 3.6 System connecting for TES-5600MAU/30

### 3.4.2 TES-5600MRN Series

TES-5600MRN / TES-5600MHN main unit connects to TES-5600RN/30 series via IR RECEIVER interfaces, it supports 1 or 2 digital infrared wireless microphone.

The main unit provides multiple audio input and output interfaces. External audio can be accessed through LINE IN interfaces; TES-5675 series hanging microphones can be connected through MIC1 / MIC2 Phoenix interface with AFC function; TES-5600CSM series microphone can be connected through MIC 3 Type A USB interface; MIC1 / 2/ 3 has a dependent volume adjustment knob; analog audio can be output via LINE OUT 1 / 2 interface, and a monitor speaker can also be connected via LINE OUT2 interface if needed; the main unit has built-in power amplifier, through the SPEAKER interface, it can be directly connected to the speaker for sound reinforcement output. AV recording system can be connected through the REC interface. PPT click function can be realized with TES-5604N\_W or TES-5608 digital infrared wireless microphone; digital laser pointer function can be realized when cooperating with TES-5608BN. Remote interaction can be realized through 3PIN phoenix interfaces REMOTE IN/OUT, with AEC function.

TES-5600MRN / TES-5600MHN main unit has a 8-PIN phoenix interface, supports RS-232 control protocol, can be seamlessly connected with TAIDEN HCS-6100 or third-party intelligent central control system, remotely control audio parameters, intelligent calibration, etc. ; trigger fire linkage alarm, and output the alarm signal input by the security system simultaneously.

TES-5600MRN has remote interaction function, remote interactive signal can be input through REMOTE IN interface, while local interactive signal can be output to remote interactive devices through REMOTE OUT interface

TES-5600CSL / TES-5600CSN) charging station or the TES-5600CSML/ TES-5600CSMN) wired microphone can be connected via RS-232 interface with TES-5600MRN / TES-5600MHN main unit. While the main unit detective its IN (right) pin and 12V pin of the 8-PIN Phoenix connected to the relay switch of central control system (as shown in Figure 3.7) are shorted. the digital infrared wireless microphone in the charging pocket can be unlocked through the touching button of TES-5600CSL / TES-5600CSN) charging station or TES-5600CSML/ TES-5600CSMN) wired microphone.

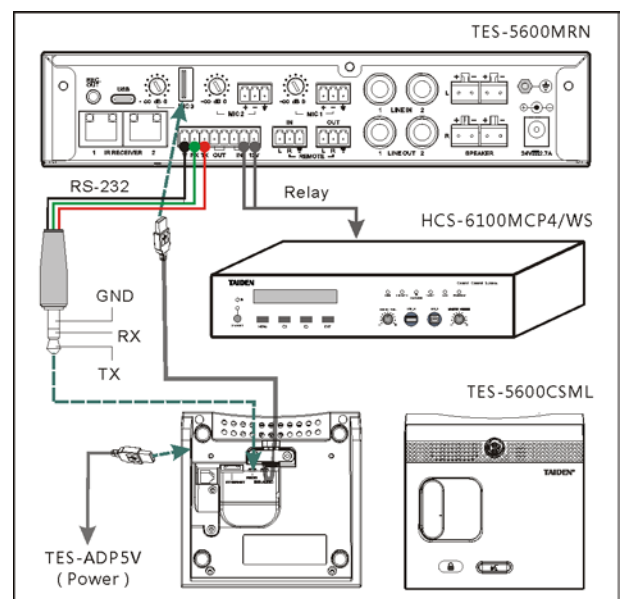

Figure 3.7 Unlock the digital infrared wireless microphone by touching button

TES-5600MRN / TES-5600MHN main unit has a LAN interface, audio parameters of the system can be setup via the TSW-5600MN Parameter Setting Tool or built-in webserver. It can also be universal adapt to TAIDEN TES-5600SW Digital Infrared Classroom Audio Management Platform to achieve unified management of devices within the campus.

**System connection:**

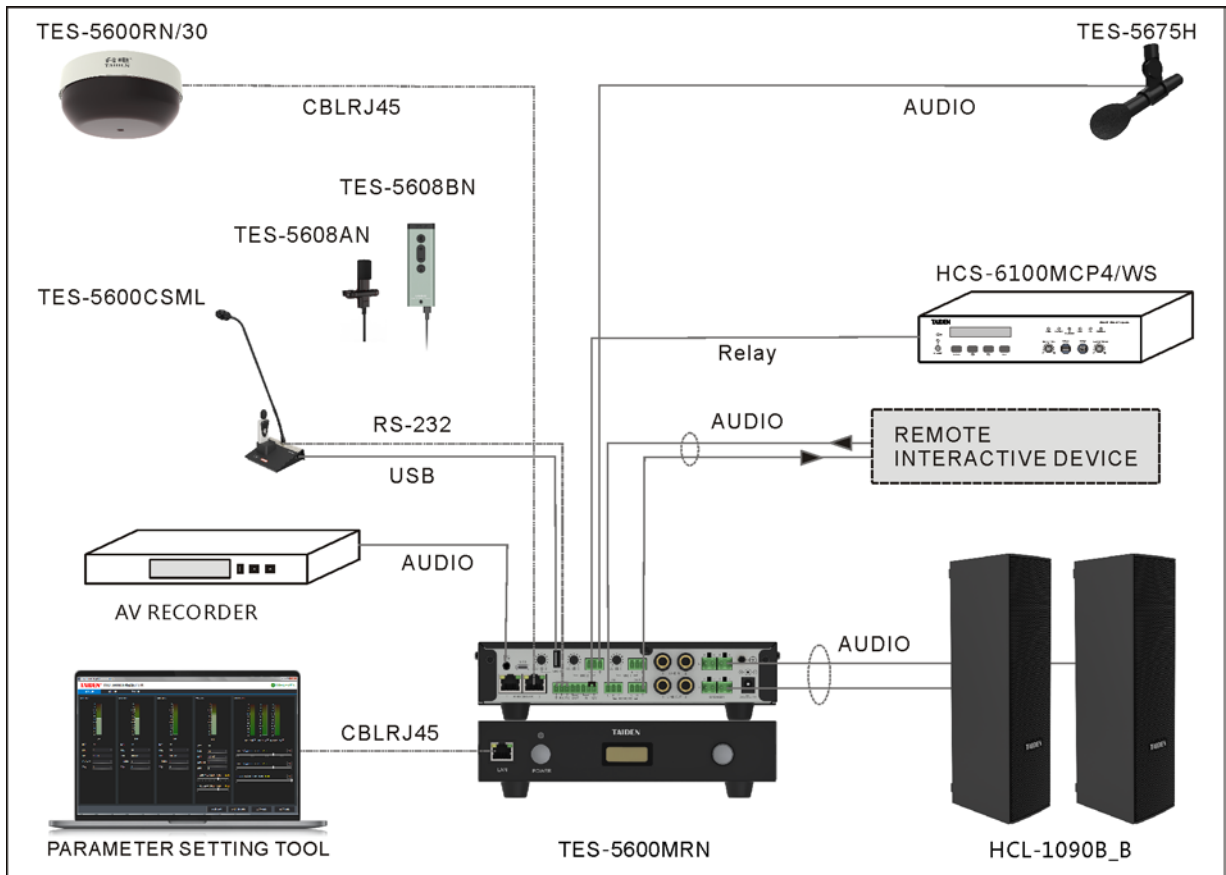

Figure 3.8 System connection for TES-5600MRN (Scene:IR+MIC2(T)+M3)

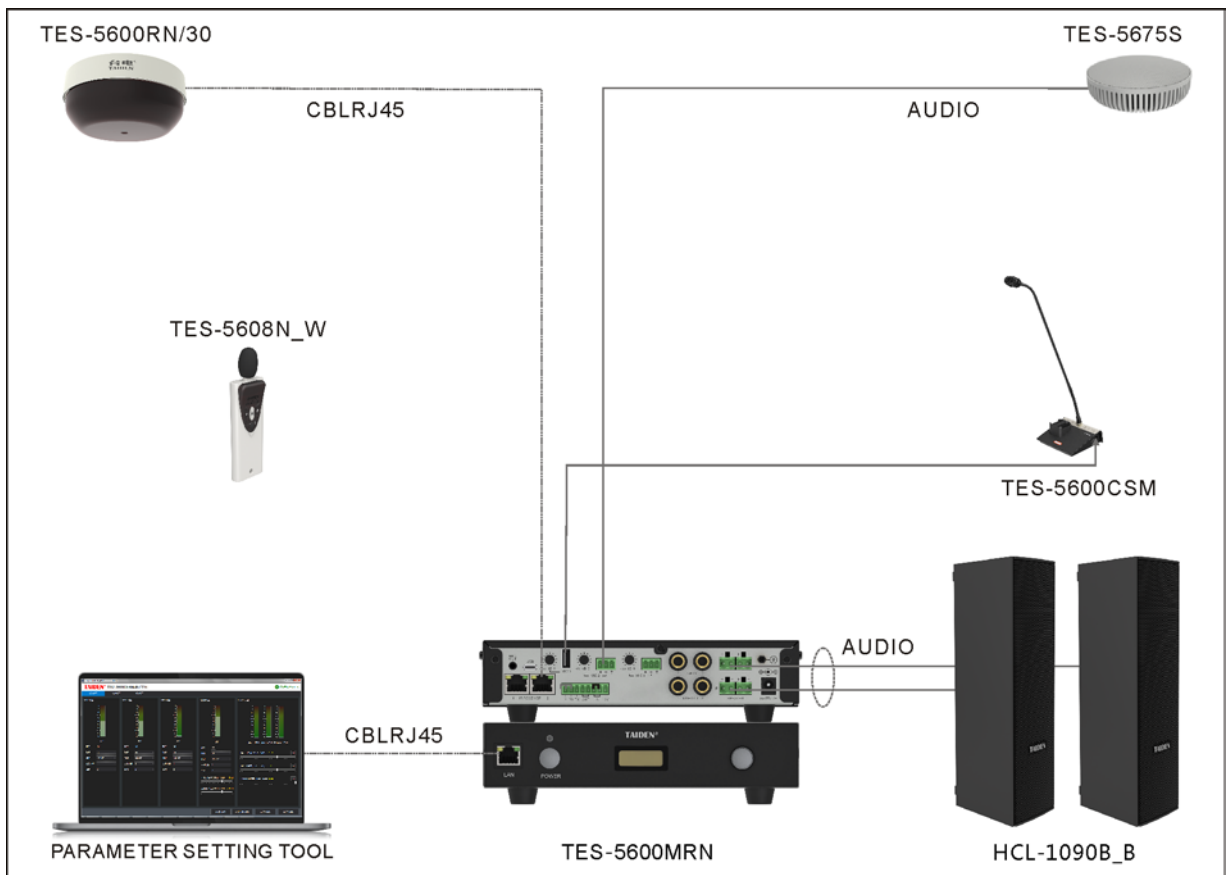

Figure 3.9 System connection for TES-5600MHN (Scene:IR+MIC2(S)+M3)

**Introduction for audio scenarios:**

The TES-5600MRN/TES-5600MHN main unit supports 5 audio scenarios: IR+M2(T)+M3, IR+M2(T)+M1(T), IR+M2(T)+M1(S), IR+M2(S)+M1(S) and IR+M2(S)+M3. You need to select "Audio Scene" in the setting menus on front panel (see details in section 3.5.2.10 Audio Scene) according to actual system connection.

**Scene 1 IR+M2(T)+M3:**

When the system adopts 1~2 TES-560x digital infrared wireless microphone, MIC2 interface connects with TES-5675T hanging microphone and MIC3 interface connects with TES-5600CSM series wired microphone. Setup Audio Scene as "IR+M2(T)+M3" in the operation menus on front panel. The relationship between audio input and output is as the below table:

Audio input \ Audio output	Line in	TES-560x IR Mic.	TES-5675T/H (MIC2)	TES-5600CSM series (MIC3)	USB digital audio in (Type-C USB)	Remote in
Speaker out	✓	✓	✓	✓	✓	✓
REC. out	✓	✓	✓	✓	✓	✓
Listen Back Out		✓	✓	✓		
USB digital audio out	✓	✓	✓	✓		✓
Remote out	✓	✓	✓	✓	✓	

**Scene 2 IR+M2(T)+M1(T):**

When the system adopts 1~2 TES-560x digital infrared wireless microphone, both MIC1 and MIC2 interfaces connect with TES-5675T hanging microphones. Please setup audio scene as "IR+M2(T)+M1(T)" in the operation menus on front panel. The relationship between audio input and output is as the below table:

Audio input \ Audio output	Line in	TES-560x IR Mic.	TES-5675T/H (MIC2)	TES-5675T (MIC1)	USB digital audio in (Type-C USB)	Remote in
Speaker out	✓	✓	✓	✓	✓	✓
REC. out	✓	✓	✓	✓	✓	✓
Listen Back Out		✓	✓	✓		
USB digital audio out	✓	✓	✓	✓		✓
Remote out	✓	✓	✓	✓	✓	

**Scene 3 IR+M2(T)+M1(S):**

When the system adopts 1~2 TES-560x digital infrared wireless microphone, MIC1 interface connects with TES-5675S hanging microphone and MIC2 interface connects with TES-5675T hanging microphone, please setup audio scene as "IR+M2(T)+M1(S)" in the operation menus on front panel. The relationship between audio input and output is as the below table:

Audio input \ Audio output	Line in	TES-560x IR Mic.	TES-5675T/H (MIC2)	TES-5675S (MIC1)	USB digital audio in (Type-C USB)	Remote in
Speaker out	✓	✓		✓	✓	✓
REC. out	✓	✓	✓	✓	✓	✓
Listen Back Out		✓	✓			
USB digital audio out	✓	✓	✓	✓		✓
Remote out	✓	✓	✓	✓	✓	

#### Scene 4 IR+M2(S)+M1(S):

When the system adopts 1~2 TES-560x digital infrared wireless microphone, both MIC1 and MIC2 interfaces connect with TES-5675S hanging microphones. Please setup Audio Scene as "IR+M2(S)+M1(S)" in the operation menus on front panel. The relationship between audio input and output is as the below table:

Audio input \ Audio output	Line in	TES-560x IR Mic.	TES-5675S (MIC2)	TES-5675S (MIC1)	USB digital audio in (Type-C USB)	Remote in
Speaker out	✓	✓			✓	✓
REC. out	✓	✓	✓	✓	✓	✓
Listen Back Out		✓				
USB digital audio out	✓	✓	✓	✓		✓
Remote out	✓	✓	✓	✓	✓	

#### Scene 5 IR+M2(S)+M3:

When the system adopts 1~2 TES-560x digital infrared wireless microphone, both MIC2 interface connects with TES-5675S hanging microphones and MIC3 connects with TES-5600CSM wired microphone. Please setup Audio Scene as "IR+M2(S)+M3" in the operation menus on front panel. The relationship between audio input and output is as the below table:

Audio input \ Audio output	Line in	TES-560x IR Mic.	TES-5675S (MIC2)	TES-5600CSM series (MIC3)	USB digital audio in (Type-C USB)	Remote in
Speaker out	✓	✓		✓	✓	✓
REC. out	✓	✓	✓	✓	✓	✓
Listen Back Out		✓		✓		
USB digital audio out	✓	✓	✓	✓		✓
Remote out	✓	✓	✓	✓	✓	

#### Note:

- ☞ IR priority mode is available for all the 5 audio scenarios.
- ☞ When IR priority mode is set as 'Yes', and TES-560x IR Mic. turns on, other microphones will be muted. The voice of TES-560x IR Mic cannot be monitored by the Listen Back Out.



### 3.4.3 TES-5600BX series

The TES-5600BX/30 series control box features built-in amplifier, microphone control and volume adjustment. TES-5600BX/30 series connects to TES-5600RN/30 series via RECEIVER interfaces, and external audio (PC) can be fed via PC IN, and TES-5600CSM series

or TES-5600MIC wired microphone can connect to the A type USB interface for audio transmission, audio output to external device (such as amplifier) via LINE BAL, and speakers connection via SPEAKER.

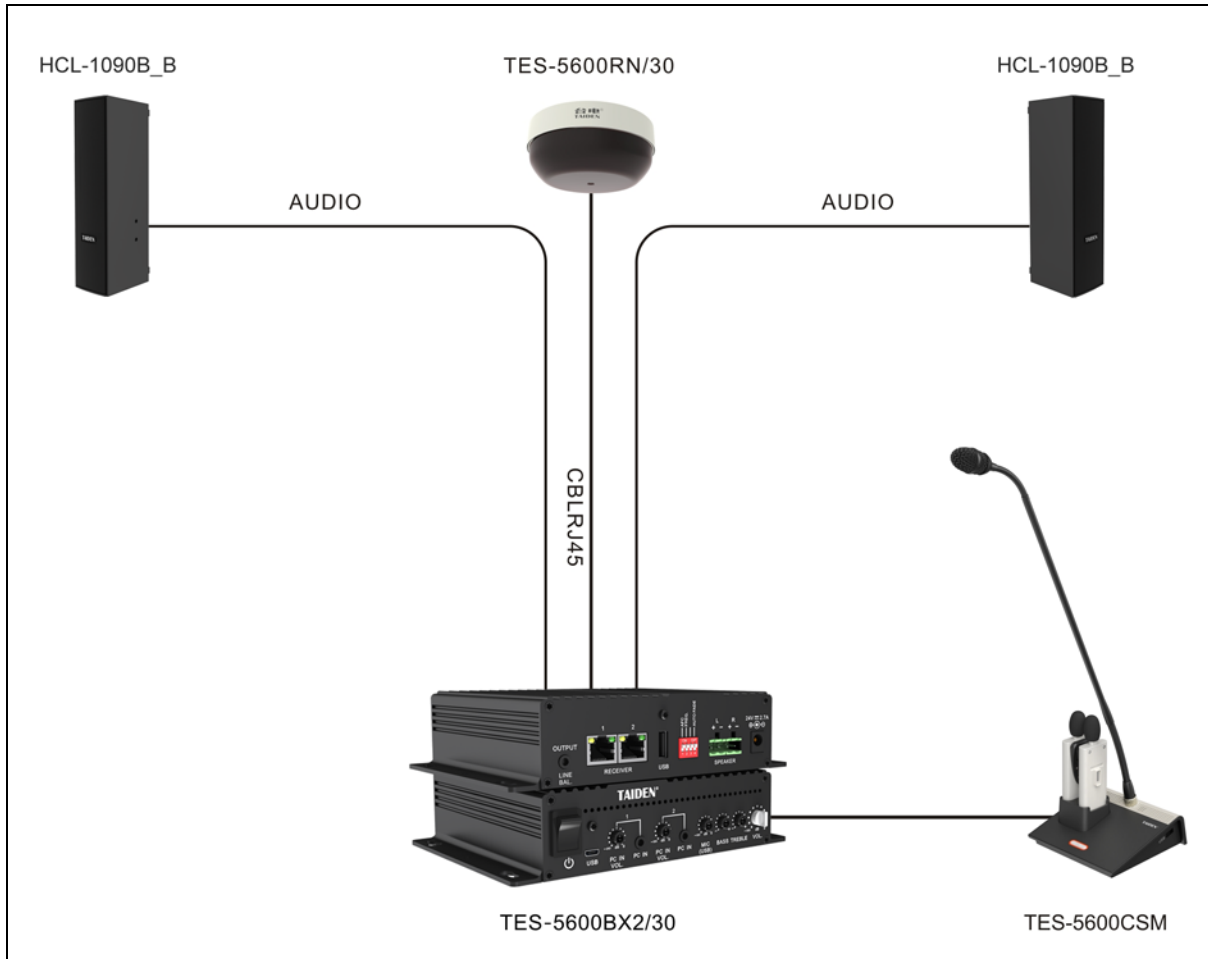

Figure 3.9 System connecting for TES-5600 series

## 3.5 Configuration and operation

### 3.5.1 TES-5600MAU series

TES-5600MAU series Digital infrared wireless system main unit can be configured and set up through menu operation with knob. All menu items operation will be introduced one by one in this section.

#### A) Starting initialization

Switch on and press the "POWER" button, the TES-5600MAU/30 digital infrared wireless system main unit will start initialization:



#### B) Initial interface on OLED

The initial interface on the OLED includes channel status and microphone battery capacity.



- Under initial interface, switch the knob to enter the master volume control menu;



Rotate the knob to adjust the volume ( range: -30 dB to 0 dB ), and then keep pressing the knob to confirm and turn back to the initial interface.

#### C) Access main menu

Pressing the knob under initial interface will go to main menu, which includes ten menu items:

1. Mic. Sens.	2. Line In Vol.
3. USB In Vol.	4. EQ Setting
5. Auto Fade	6. FB Suppress
7. Line In 1 Set.	8. Remote Ctrl.
9. Mic Low Cut	10. Cursor Speed
11. Music/Voice	12. Child Lock
13. Language	14. Factory Reset
15. About	



- Rotate the knob to switch submenus one by one;
- Press the knob to go to the corresponding submenus.

#### Note:

- Keep pressing the knob to return to the OLED initial interface under any menu.

#### 3.5.1.1 Mic Sens.

Adjust the sensitivity of the digital infrared wireless microphones.

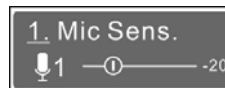

- Press the knob to enter the microphone selection interface;



- Rotate the knob to select a microphone, and then press the knob to enter the sensitivity adjusting interface, the hollow pellet will turn solid;



- Adjust the sensitivity by rotating the knob and then press the knob to confirm.

#### Note:

- The function parameters are usually adjusted only during the initial installation.
- User can adjust the sensitivity of the current microphone through the wireless microphone, and the cursor indicates the actual sensitivity.

### 3.5.1.2 Line In Vol.

Adjust the volume of Line In, range:  $-\infty$  (mute), -30 dB to 0 dB.



1. Press the knob to enter the line in selection interface;



2. Press the knob to enter volume adjustment interface;



3. Rotate the knob to adjust the volume and then press the knob to confirm.

### 3.5.1.3 USB In Vol.

Adjust the volume of the digital audio input for USB LINK.



1. Press the knob to enter the volume adjustment interface, the hollow pellet will turn solid;



2. Rotate the knob to adjust the volume and then press the knob to confirm.



### 3.5.1.4 EQ Setting

Set up the EQ of Line Out and speaker.

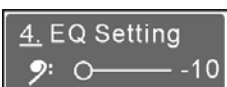

1. Press the knob to enter and select bass or treble;

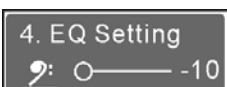

Bass

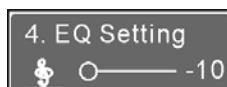

Treble

2. Press the knob to enter the EQ adjusting interface, the hollow pellet will turn solid;



3. Rotate the knob to adjust the EQ, range: -10 dB to +10 dB;

4. Press the knob to confirm.

### 3.5.1.5 Auto Fade

Select the trigger signal sources of LINE IN fade. LINE IN volume will be reduced 18 dB after triggering.



1. Press the knob to enter the setting interface;



2. Rotate the knob to select a fade way among Off, Low Voice, High Voice and IR Signal.

- **Voice trigger:** LINE IN audio fade will be trigger when voice reaches the certain sound pressure. It includes Low Voice and High Voice.

- **IR signal:** LINE IN audio fade will be controlled by microphone on/off.

3. Press the knob to confirm.

#### Note:

☞ Auto Fade is invalid for LINE IN 1 if it is used for microphone input.

### 3.5.1.6 FB Suppress

Set a FB (feedback) suppress level.

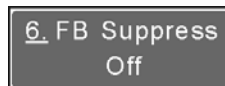

1. Press the knob to enter the setting interface;

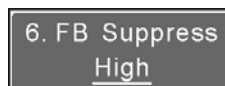

2. Rotate the knob to select a level among Off, High and Low.

3. Press the knob to confirm after adjusting.

#### Note:

☞ The higher the FB suppress level, the better the FB suppress effect. But high level setting may have an impact on the sound quality, so please select the reasonable FB suppress.

### 3.5.1.7 Line In 1 Set.

7. Line In 1 Set  
Line In

1. Press the knob to enter the setting interface;

7. Line In 1 Set  
Mic In

2. Rotate the knob to select a type between Line In, Mic In and USB Mic, if select "Line In" or "USB Mic", press the knob to confirm;

If select "Mic In", press the knob to enter the step 3 Phantom Power set up;

If select "USB Mic", press the knob to enter the step 4 Mute by IR Mic set up.

Phantom Power  
Off

3. Rotate the knob to select On or Off and then press the knob to enter the step 4 Mute by IR Mic set up.

If select "On", the wired microphone will be mute when the digital IR wireless microphone is on.

Mute by IR Mic  
Off

4. Rotate the knob to select On or Off and then press the knob to confirm.

### 3.5.1.8 Remote Ctrl.

User can finely adjust the sensitivity of the current microphone through the TES-560x IR wireless microphone based on the set Mic Sens. Remote Ctrl. sets the permission and adjustment range.

8. Remote Ctrl.  
+/-9 (dB)

1. Press the knob to enter the setting interface;

8. Remote Ctrl.  
+/-3 (dB)

2. Rotate the knob to select a range or off, and then press the knob to confirm.

### 3.5.1.9 Mic Low Cut

Set the low cut of microphone.

9. Mic Low Cut  
Solution 2

1. Press the knob to enter the setting interface;

9. Mic Low Cut  
Solution 1

2. Rotate the knob to select a solution and then press the knob to confirm.

#### Note:

☞ We suggest selecting solution1 when connecting to HPA-2240/2360 speaker and solution2 when connecting to HPA-1000 series line array column loudspeaker.

### 3.5.1.10 Cursor Speed

Set cursor speed. When the main unit is used with the TES-5608BN digital infrared wireless microphone, the moving speed of the digital laser pointer can be set.

10. Cursor Speed  
0

1. Press the knob to enter the setting interface;

10. Cursor Speed  
+2

2. Rotate the knob to select cursor speed, the adjustable range is -2 ~ +2. Then press the knob to confirm.

### 3.5.1.11 Music/Voice

Set the sound effects of speakers.

11. Voice/Music  
Music

1. Press the knob to enter the setting interface;

11. IR Priority  
Voice

2. Rotate the knob to select a sound effect and then press the knob to confirm.

### 3.5.1.12 Child Lock

Set the child lock function.



12. Child Lock  
Off

1. Press the knob to enter the setting interface;



12. Child Lock  
On

2. Rotate the knob to select and then press the knob to confirm.

When the Child Lock is on, an icon “🔒” will display on the initial interface. If there is no operation in 1 minute, an icon “🔒” will display and the menu interface is locked. The prompt interface as below:

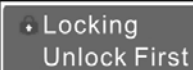

Locking  
Unlock First

Under this interface, operate “Press the knob and then right rotate the knob” for four times, then press the knob again to unlock.

### 3.5.1.13 Language

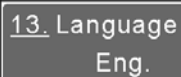

13. Language  
Eng.

1. Press the knob to enter the setting interface;

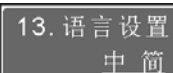

13. 语言设置  
中简

2. Rotate the knob to select a language and then press the knob to confirm.

### 3.5.1.14 Factory Reset



14. Factory Reset  
No Yes

1. Press the knob to enter the setting interface;

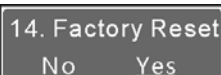

14. Factory Reset  
No Yes

2. Rotate the knob to select “Yes” or “No”.

### 3.5.1.15 About

Display the version of the device.

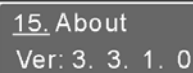

15. About  
Ver: 3. 3. 1. 0

In this interface, user also can see the information of the microphone in use, see and change the receivable frequencies of the main unit.

#### ■ See the information of microphone in use



15. About<2.3M>  
Ver: 2.03.00.00

In the “About” interface, power on a microphone or press the “MUTE” button on the microphone, its version and frequency will be displayed.

#### ■ See the receivable frequencies of the main unit



15. About.  
1 3.6M 2 2.3M

In the “About” interface, press the knob to see the receivable frequencies of the main unit and press the knob again to return to the “About” interface.

#### ■ Change the receivable frequencies of the main unit



15. About...  
Ver: 3. 3. 1. 0

1. Press the knob and then clockwise rotate it, operate the step for 4 times (4 points will display after “About”), then press the knob again to enter the “Set Mic Freq.” menu;



Set Mic Freq.  
4: 3.6M 2.3M

2. Rotate the knob to change the frequency.

There are 4 groups of frequencies can be selected: 1.6/2.3 M, 3.0/2.3 M, 3.0/1.6 M and 3.6/2.3 M.

3. Long press the knob to enable and turn back to the initial interface.

**Note:**

- ☞ Please use the receivable frequencies changing function restrainedly for keeping normal use;
- ☞ Factory reset is invalid for receivable frequencies changing.

**Protection**

- **IR receiver protection:** activated when the IR receiver short circuit or other unusual circumstance happens, the OLED displays “IR Receiver Abnormal!”
- **Alarm function:** activated when a high level being input to the phoenix interface or the controllable microphone or central control system send an alarm signal to the main unit, the OLED displays “Alarm On!”

### 3.5.2 TES-5600MRN series

TES-5600MRN Digital infrared wireless system main unit can be configured and set up through menu operation with knob. All menu items operation will be introduced one by one in this section.

#### A) Starting initialization

Switch on and press the "POWER" button, the TES-5600MRN digital infrared wireless system main unit will start initialization:



#### B) Initial interface on OLED

The initial interface on the OLED includes channel status and microphone battery capacity.



- Under initial interface, switch the knob to enter the master volume control menu;



Rotate the knob to adjust the volume ( range: -30 dB to 0 dB ), and then keep pressing the knob to confirm and turn back to the initial interface.

#### C) Access main menu

Pressing the knob under initial interface will go to main menu, which includes ten menu items:

1. IR Mic. Sens.	2. Line In Vol.
3. EQ Setting"	4. Auto Fade
5. AEQ Calibrate	6. Line Out 2 Set
7. Remote in Vol.	8. Remote out Vol
9. IR Ctrl. Vol.	10. Audio Scene
11. IR Priority	12. Child Lock
13. Language	14. Factory Reset
15. Cursor Speed	16. IP Adress
17. Baudrate	18. C Mic Max.gain
19. USB Out Vol.	20. About
21. About DSP	



- Rotate the knob to switch submenus one by one;
- Press the knob to go to the corresponding submenus.

#### Note:

- Keep pressing the knob to return to the OLED initial interface under any menu.

#### 3.5.2.1 IR Mic Sens.

Adjust the sensitivity of the digital infrared wireless microphones.



- Press the knob to enter the microphone selection interface;



- Rotate the knob to select a microphone, and then press the knob to enter the sensitivity adjusting interface, the hollow pellet will turn solid;



- Adjust the sensitivity by rotating the knob and then press the knob to confirm.

#### Note:

- The function parameters are usually adjusted only during the initial installation.
- User can adjust the sensitivity of the current microphone through the wireless microphone, and the cursor indicates the actual sensitivity.

### 3.5.2.2 Line In Vol.

Adjust the volume of Line In, range:  $-\infty$  (mute), -30 dB to 0 dB.



1. Press the knob to enter the line in selection interface;



2. Press the knob to enter volume adjustment interface;



3. Rotate the knob to adjust the volume and then press the knob to confirm.

### 3.5.2.3 EQ Setting

Set up the EQ of Line Out and speaker.

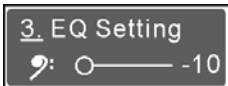

1. Press the knob to enter and select bass or treble;



**Bass**

**Treble**

2. Press the knob to enter the EQ adjusting interface, the hollow pellet will turn solid;

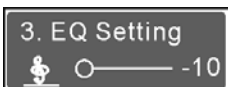

3. Rotate the knob to adjust the EQ, range: -10 dB to +10 dB;

4. Press the knob to confirm.

### 3.5.2.4 Auto Fade

Select the trigger signal sources of LINE IN fade. LINE IN volume will be reduced 18 dB after triggering.



1. Press the knob to enter the setting interface;



2. Rotate the knob to select a fade way among Off, Low Voice, High Voice and IR Signal.

- **Voice trigger:** LINE IN audio fade will be triggered when voice reaches the certain sound pressure. It includes Low Voice and High Voice.
- **IR signal:** LINE IN audio fade will be controlled by microphone on/off.

3. Press the knob to confirm.

### 3.5.2.5 AEQ Calibrate

Used to calibrate the audio parameters of the audio device connected to the system in the current environment.

1. Press the knob to enter the setting interface;

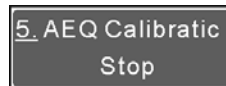

2. Rotate the knob to switch to "Start"



3. Press the knob to confirm.

The system will enter AEQ calibration state, pink noise will play about half a minute. After that, please aim at the TES-5675 series hanging microphone and speak as loudly as possible.

4. Press the knob to enter the setting interface again and check if it prompts up "Success". The calibrated parameters are automatically recorded by the system.

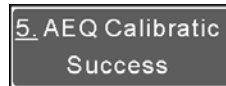

#### Note:

- ☞ If "Success" is not displayed for a long time, please press the knob to return and select "Start" again to perform AEQ calibration again. After the system stops playing pink noise, aim at the TES-5675 series hanging microphone and speak as loudly as possible until it displays. "Success".



### 3.5.2.6 Line Out 2 Set.

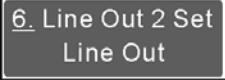

1. Press the knob to enter the setting interface;

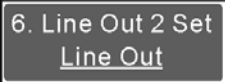

2. Rotate the knob to select function for interface Line out2 between "Line Out" and "Listen Back Out",

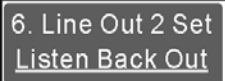

3. Press the knob to confirm.

**Note:**

The listen back out function will be unavailable when the IR priority is being set up.

### 3.5.2.7 Remote In Vol.

Adjust the volume of remote In, range:  $-\infty$  (mute), -30 dB to 0 dB.



2. Press the knob to enter volume adjustment interface;



3. Rotate the knob to adjust the volume and then press the knob to confirm.

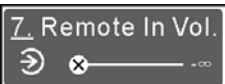

### 3.5.2.8 Remote Out Vol.

Adjust the volume of remote out, range:  $-\infty$  (mute), -30 dB to 0 dB.



2. Press the knob to enter volume adjustment interface;

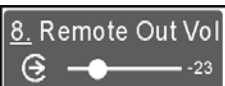

3. Rotate the knob to adjust the volume and then press the knob to confirm.



### 3.5.2.9 IR Ctrl. Vol.

User can adjust the sensitivity of the current microphone through the TES-560x IR wireless microphone based on the **IR Ctrl.Vol.** sets the permission and adjustment range.

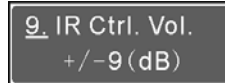

1. Press the knob to enter the setting interface;

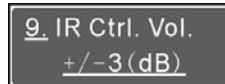

2. Rotate the knob to select **+/-3(dB)**, **+/-6(dB)** or **+/-9(dB)** or **Off**, and then press the knob to confirm. The volume adjustable range of the "IR Mic. Sens."(referred in section [3.5.2.1](#)) will be affected accordingly, and the corresponding relationship is as follows:

IR Ctrl. Vol.	IR Mic. Sens. range
Off	-30 ~ 0 dB
+/-3(dB)	-27 ~ -3 dB
+/-6(dB)	-24 ~ -6 dB
+/-9(dB)	-21 ~ -9 dB

### 3.5.2.10 Audio Scene

TES-5600MAH and TES-5600MAR support 5 audio scenarios.

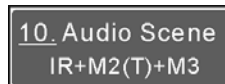

1. Press the knob to enter the setting interface;

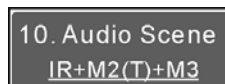

2. Rotate the knob to select **IR+M2(T)+M3**, **IR+M2(T)+M1(T)**, **IR+M2(T)+M1(S)**, **IR+M2(S)+M1(S)** or **IR+M2(S)+M3** according to actual system connection, and then press the knob to confirm.

IR	Digital Infrared Wireless Microphone
M1	TES-5675 series hanging microphone connected to MIC1 interface
M2	TES-5675 series hanging microphone connected to MIC2 interface
M3	TES-5600CSM series wired microphone connected to Type A USB interface
T	TES-5675T/H hanging microphone for teachers
S	TES-5675S hanging microphone for Student

**Note:**

☞ Please repower the main unit after setting the audio scene.

### 3.5.2.11 IR Priority

Set the IR Priority mode.

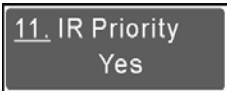

1. Press the knob to enter the setting interface;

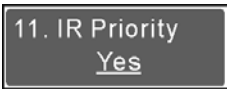

2. Rotate the knob to select **Yes** or **No**, and then press the knob to confirm.

**Yes:** Setup IR Priority mode, once TES-560x digital IR wireless microphone turns on, all other microphone will be muted;

**No:** Close IR Priority mode

**Note:**

- ☞ IR priority mode is available for all the 5 audio scenarios.
- ☞ Please repower the main unit after setting the IR priority mode

### 3.5.2.12 Child Lock

Set the child lock function.



1. Press the knob to enter the setting interface;



2. Rotate the knob to select and then press the knob to

confirm.



When the Child Lock is on, an icon “🔒” will display on the initial interface. If there is no operation in 1 minute, an icon “🔒” will display and the menu interface is locked. The prompt interface as below:



In this interface, you can press the knob five times to unlock.

### 3.5.2.13 Language

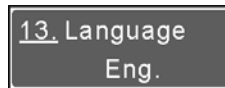

1. Press the knob to enter the setting interface;



2. Rotate the knob to select a language and then press the knob to confirm.

### 3.5.2.14 Factory Reset

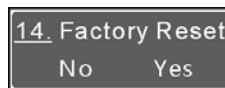

1. Press the knob to enter the setting interface;



2. Rotate the knob to select “Yes” or “No”.

### 3.5.2.15 Cursor Speed

Set cursor speed. When the main unit is used with the TES-5608BN digital infrared wireless microphone, the moving speed of the digital laser pointer can be set.

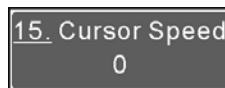

1. Press the knob to enter the setting interface;

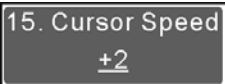

2. Rotate the knob to select cursor speed, the adjustable range is -2 ~ +2. Then press the knob to confirm.

### 3.5.2.16 IP Address

Set the IP address of the system.



1. Rotate the knob to switch between the four numbers, and press the knob to select a number;



2. Rotate the knob to adjust the value, press the knob to confirm.

#### Note:

☞ Default subnet mask is 255.255.255.0 and gateway is 192.168.1.7. You can edit through the built-in webserver.

### 3.5.2.17 Baudrate

Set baudrate for RS-232 interface.

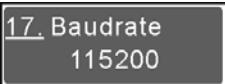

1. Press the knob to enter the setting interface;

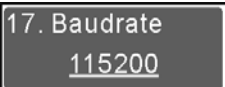

2. Rotate the knob to select and then press the knob to confirm.

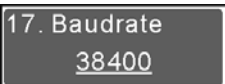

### 3.5.2.18 C Mic Max.gain

Adjust the maximum gain of TES-5675 series hanging microphones connected via MIC1/2 interface.



1. Press the knob to enter the maximum gain selection

interface;



2. Rotate the knob to select a suitable maximum gain and then press the knob to confirm.



### 3.5.2.19 USB Out Vol.

Adjust the volume of audio out channel of USB LINK, range: -∞ (mute), -30 dB to 0 dB.



2. Press the knob to enter volume adjustment interface;



3. Rotate the knob to adjust the volume and then press the knob to confirm.



### 3.5.2.20 About

Display the firmware version of the device.

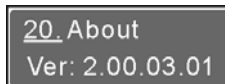

In this interface, user also can see the information of the microphone in use, see and change the receivable frequencies of the main unit.

#### ■ Review the information of microphone in use



In the “About” interface, power on a microphone or press the “MUTE” button on the microphone, its version and frequency will be displayed.

#### ■ Review the receivable frequencies

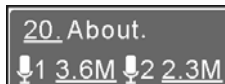

In the "About" interface, press the knob to see the receivable frequencies of the main unit and press the knob again to return to the "About" interface.

**Note:**

☞ The TES-5600MRN series main unit supports two digital infrared microphones, 3.6M and 2.3M, to be used at the same time. Please set the frequency of the digital infrared wireless microphone to 3.6M or 2.3M accordingly.

### 3.5.2.21 About DSP

Display the DSP version of the device.



### 3.5.2.22 Alarm function:

Activated when a high level being input to the phoenix interface or the controllable microphone or central control system send an alarm signal to the main unit, the OLED displays "Alarm On!"

The alarm switch (the IN (left) pin and the 12V pin of the 8-PIN Phoenix shorted/not shorted), the central control system or the pendant digital infrared wireless microphone can all trig the alarm. After the alarm is triggered, the OUT pin and ground pin of the 8-PIN Phoenix output 12V voltage, which can be connected to a third-party alarm device to transmit the alarm-on message to the campus security center or related department. Meanwhile, the main unit will report its alarm status to the central control system, and "Alarm On!" will always display until the alarm is eliminated. During that period, the front panel will be locked and no other operations can be performed.

### 3.5.2.22 Built-in Webserver

The ETHERNET interface of the TES-5600MRN and TES-5600MHN main unit can be connected network with the PC. Enter the IP address of the main unit in the address bar of the browser, and enter the password (default "TAIDEN-5600") in the login interface to access the built-in webserver.

The built-in webserver has multiple functions, such as querying the current firmware and DSP version, set the

volume parameters for each input/output of the system, intelligent AEQ calibration and set network parameters of local device and the server of TAIDEN TES-5600SW Digital Wireless Classroom Audio Management Platform, ie. IP address, communication port, etc.

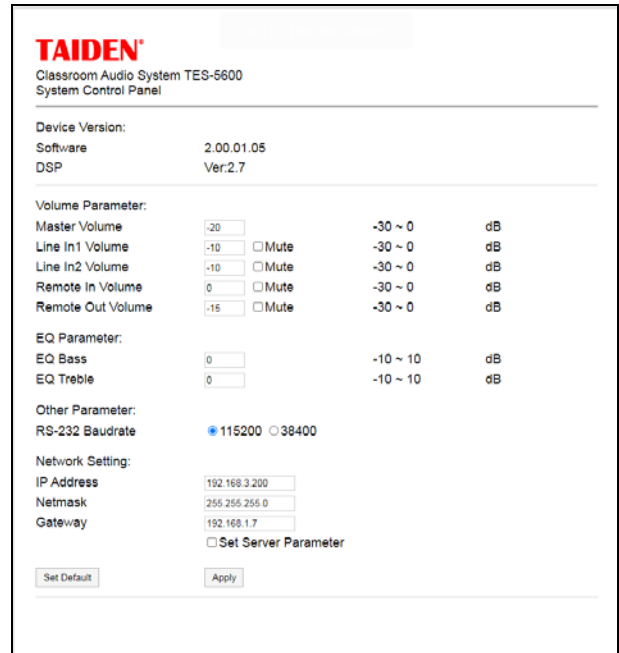

Figure 3.10 Built-in Webserver of main unit

- Device Version: Display the device firmware and DSP version number.
- Volume Parameter: Audio parameter settings.

Volume Parameter	Audio adjusted	Adjustable range	Mute
Master Volume	Speaker LINE OUT	-30 ~ 0 dB	
Line In1 Volume	LINE IN1		✓
Line In2 Volume	LINE IN2		✓
Remote In Volume	REMOTE IN		✓
Remote Out Volume	REMOTE OUT		✓

- EQ Parameter: EQ equalization parameter setting.
  - EQ Bass: Adjust bass, range: -10 ~ 10 dB;
  - EQ Treble: Adjust high volume, range: -10 ~ 10 dB;
- Network Setting: Local and server network settings.
  - Manually set the host IP address, subnet mask and gateway, and also support DHCP to automatically obtain network settings.
  - Check "Set Server Parameter" to set the IP address and service port number of the TAIDEN TES-5600SW Digital Wireless Classroom Audio Management Platform.
- Apply: apply settings;
- Set Default: restore the default value

### 3.5.3 TES-5600BX series

#### 3.5.3.1. Speaker volume

Adjust the volume of speakers and LINE OUT via the "VOL." knob on the TES-5600BX/30 control box, range -30 dB to 0 dB.

#### 3.5.3.2. Treble/bass

Adjust the treble/bass of line out and speakers via the "Treble"/"Bass" knobs on the TES-5600BX/30 control box, range -10 dB to 10 dB.

**Note:**

☞ The bass/treble is usually adjusted only during the initial installation.

#### 3.5.3.3. PC IN and volume

TES-5600BX/30 control box has two PC IN interfaces for external audio input, and puts out their mixed audio, the volume can be adjusted via PC IN knobs.

#### 3.5.3.4. External microphone in and volume

An A type USB interface can connect to the external microphone (TES-5600CSM series or TES-5600MIC) and adjust the volume via MIC(USB) knob.

#### 3.5.3.5. Function switcher

Setting the function parameters via the switcher (switch up is 1, switch down is 0)

Function	1	0
1. AFC function	On	Off
2. IR frequency	TES-5600BX2/30 2.33/3.67 MHz TES-5600BX1/30 2.33 MHz	TES-5600BX2/30 1.67/3.0 MHz TES-5600BX1/30 1.67 MHz
3. Mic low cut	Solution 2	Solution 1
4. Auto. fade	On	Off

**Note:**

- ☞ The function parameters are usually adjusted only during the initial installation.
- ☞ Mic low cut: We suggest selecting solution1 when connecting to HPA-2240 speaker and solution2 when connecting to HPA-1000 series line array column loudspeaker.
- ☞ The auto fade only effect for line in.

### 3.6 USB LINK

TES-5600MAU series / TES-5600MRN series / TES-5600BX series main unit can use as a HD keyboard device and can support remote PPT function and digital laser pointer function. TES-5600MAU/30 series / TES-5600MRN series main unit also has a built-in USB Audio (2 channels, 16bit, 44.1kHz) which can be connected to the computer through USB cable (software requirement: Win7 or higher) for digital audio input/output. In the following we take Win7 system as an example to introduce the functions and operations of the USB LINK.

#### 3.6.1 Installation of USB LINK

Once the TES-5600MAU series / TES-5600MRN series / TES-5600BX series main unit connects to a computer, the TES-5600M USB LINK will be detected automatically. If it is connected for the first time, the USB device driver will be recognized and installed automatically, as shown in the following figure:

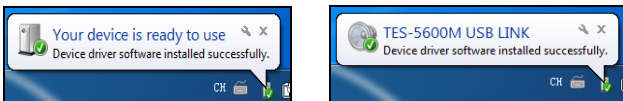

Figure 3.9: Installing USB LINK

After successful installation, the user can check the information of TES-5600M USB LINK from “Device Manager”, as shown in the following figure:

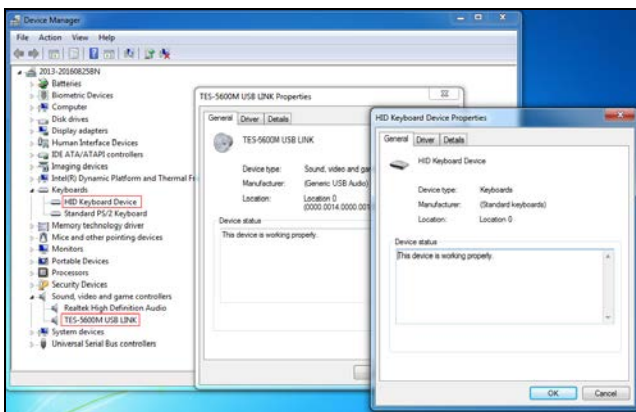

Figure 3.11: Information of USB LINK

#### 3.6.4 Remote PPT Click Function

When the TES-5600MAU series / TES-5600MRN series / TES-5600BX series main unit is connected to a PC via B-type / C-type USB interface, remote PPT click function can be realized with TES-560x digital infrared wireless microphone, see [6.4.5](#) for details

### 3.6.5 Digital Laser Pointer

When TES-5600MAU series / TES-5600MRN series / TES-5600BX series main unit is connected to a PC via B-type / C-type USB interface, and the TSW-5608B digital laser pointer setting tool runs on the PC, digital laser pointer function can be realized with TES-5608N. Please refer to [6.4.10](#) for the operation details.

#### 3.6.2 Digital audio output

When the TES-5600MAU series / TES-5600MRN series main unit is connected to computer with USB cable, lossless sound can be recorded during class on computer. Using the recording software or the third party communication software, such as recorder, Skype and so on, functions like recording, remote instruction, remote communication can be implemented.

Please adjust and test the TES-5600M USB LINK to a suitable volume when first using. Adjust method: open the control panel-sound (or right click the volume icon on the taskbar and select sound), and select the Microphone (TES-5600M USB LINK) and modify its setting on the Recording dialog box. Shown as the following figure:

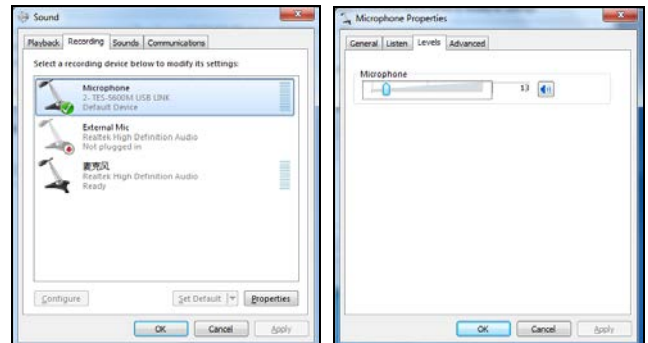

Figure 3.12: Adjusting microphone volume

**Note:**

- ☞ High volume may lead to distortion, user can confirm a suitable volume by recording and playback when necessary;
- ☞ When recording under compressed format such as MP3, the audio quality may be affected if using unsuitable sampling rate or resolution so it is suggested to select 44.1kHz or its multiple for the sampling rate and 16 bit for the resolution;
- ☞ In “Microphone Properties- Listen”, please disable “Listen to this device” (TES-5600M USB LINK) to avoid echo.
- ☞ Please select the TES-5600M USB LINK as the

current device on recording or communication. Usually, TES-5600M USB LINK will be automatically activated after connecting to the computer, instead of the default audio device. If there is error in recording, please select the sound card manually in case there is a mistake in the setting.

**Note:**

Please select the TES-5600M USB LINK as the current device on playback. Usually, TES-5600M USB LINK will be activated after connecting to the computer, instead of the default audio device. If there is an error in playback, please select the TES-5600M USB LINK manually in case there is a mistake in audio device selection. Take the Media Player as an example to show the audio device selection:

**3.6.3 Digital audio input**

The TES-5600MAU/30 main unit can be connected to the computer for digital audio input. Please adjust and test the TES-5600M USB LINK to a suitable volume when using for the first time. Adjust method: open the control panel-sound (or right click the volume icon on the taskbar and select sound), and select the speakers (TES-5600M USB LINK) and modify its setting in the Playback dialog box, as shown in the following figure:

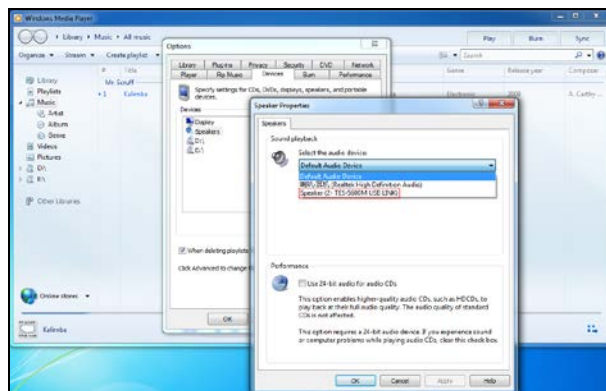

Figure 3.14: Audio device selection

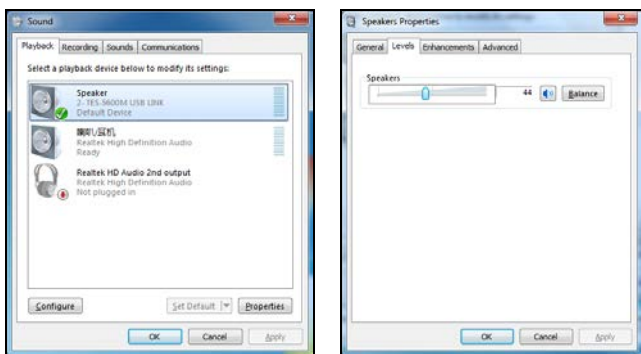

Figure 3.13: Adjusting playback volume

# Chapter 4 TES-5690 Series Classroom Audio System

## 4.1 Overview

TAIDEN TES-5690 series digital infrared classroom audio system integrated main unit and professional digital audio power amplifier, which can connect to speakers, support 2 IR microphone for interaction of teacher and students. It with central control interface for realizing centralized control.

TES-5690M is rack mounted to make the cabinet more concise.

### Types:

#### **TES-5690MA**

Digital Infrared Classroom Audio System Main Unit (supports 2 wireless microphones, with DSP, built-in audio power amplifier 2×200 W+2×60 W, network control)

#### **TES-5690MB**

Digital Infrared Classroom Audio System Main Unit (supports 2 wireless microphones, with DSP, built-in audio power amplifier 2×200 W, network control)

#### **TES-5690MC**

Digital Infrared Classroom Audio System Main Unit (supports 2 wireless microphones, with DSP, built-in audio power amplifier 4×60 W, network control)



## 4.2 Functions and indications

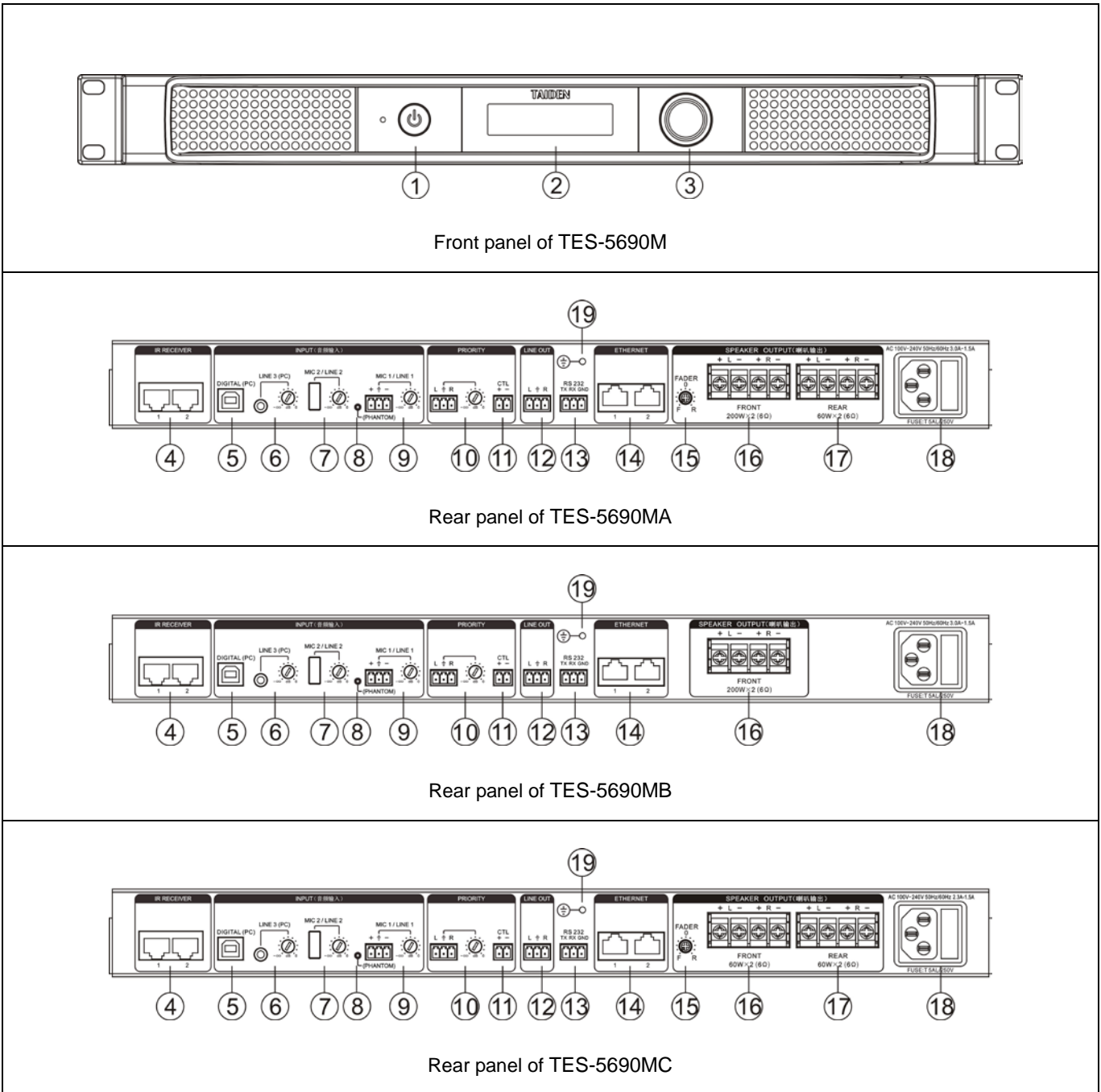

Figure 4.1 TES-5690 series classroom audio system

Figure 4.1:

**1. Power button**

**2. Menu display**

- LCD displays main unit status and configuration menu.

**3. Knob**

- For menu operation;
- For master volume control.

**4. IR RECEIVER ( RJ45)**

- Connect to TES-5600RN/30 series digital IR receiver or TES-0104T/30 splitter for transmitting signals

**5. B type USB interface**

- For firmware upgrade
- For digital audio input/output
- Connect to PC for remote control of PPT slides

**6. LINE3 (PC) IN and volume knob**

- Ø 3.5 mm, for stereo analog audio input

**7. MIC2/LINE2 IN and volume knob**

- A tape USB, for connecting to TES-5600CSM or TES-5600MIC wired microphone for audio transmission

**8. Phantom power indicator**

**9. MIC1/LINE1 IN and volume knob**

- 3P phoenix interface, for analog balanced audio input, with phantom power

**10. Priority IN and volume knob**

- 3P phoenix interface, for stereo analog audio input

**11. CTL trigger interface**

- System output the audio of priority interface when it is short circuiting.

**12. LINE OUT**

- 3P phoenix interface, for stereo analog audio input

**13. RS232 interface**

- 3P phoenix interface, for connecting to central control system

**14. ETHERNET**

- Connecting to Ethernet for searching status and adjusting parameters through web page

**15. FADER knob**

- For adjusting the fader between front speakers and rear speakers

**16. Front speaker interface (6Ω)**

**17. Rear speaker interface (6Ω)**

- For extended rear field supplementary speaker

**18. Power interface**

**19. GND**

### 4.3 Connection

The TES-5690M series Digital Infrared Classroom Audio System Main Unit connects to TES-5600RN/30 series Digital Infrared Receiver which features built-in amplifier, microphone control and volume adjustment. TES-5690M series connects to TES-5600RN/30 series via RECEIVER interfaces, and external audio (PC) can be fed via LINE1/LINE3, and TES-5600CSM series or TES-5600MIC wired microphone can connect to LINE2 (A type USB) for audio transmission. TES-5690M main unit is equipped with a priority interface, when the CTL

trigger is enabled, the audio of priority will be routed to all the outputs with all other inputs muted.

TES-5690M main unit is also equipped with a B type USB which can connect to PC for digital audio input/output, and remote control of PPT slides can be realized with a TES-560x series digital IR wireless microphone.

In the system, audio output to external device (such as amplifier) via LINE OUT, and speakers connection via SPEAKER and the fade is adjustable.

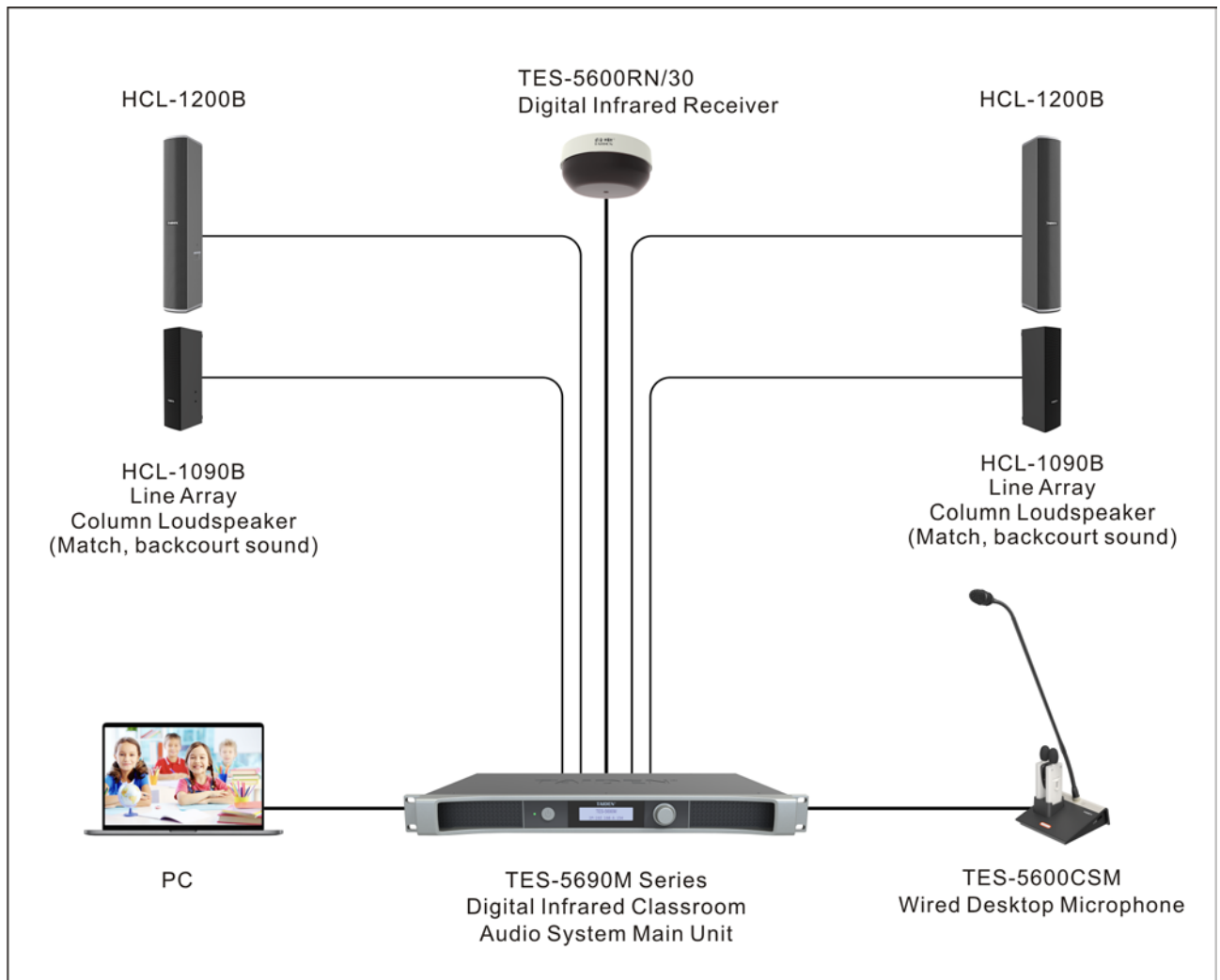

Figure 4.2 System connecting for TES-5690 series

## 4.4 Configuration and operation

TES-5690M series Digital infrared wireless system main unit can be configured and set up through menu operation with knob. All menu items operation will be introduced one by one in this section.

### A) Initial interface on LCD

The initial interface on the LCD includes channel, alarm and web status.



- Under initial interface, switch the knob to enter the speaker volume control menu;



Rotate the knob to adjust the volume ( range: -30 dB to 0 dB ) , and then pressing the knob to confirm and turn back to the initial interface.

### B) Access main menu

Pressing the knob under initial interface will go to main menu, which includes ten menu items:

“IR Mic Sens.”	“Line Out Vol.”
“Phantom Power”	“Mute by IR Mic”
“Remote Ctrl”	“Carrier Select”
“Language”	“Network”
“Auto Fade”	“FB Suppress”
“Factory Reset”	“About”
“Return”	



- Rotate the knob to switch submenus one by one;
- Press the knob to go to the corresponding submenus.

**Note:**

- Keep pressing the knob to return to the OLED initial interface under any menu.

### 4.4.1 IR Mic Sens.

Adjust the sensitivity of the digital infrared wireless microphones.



1. Rotate the knob to select a microphone, and then press the knob to enter the microphone selection interface;



3. Adjust the sensitivity by rotating the knob and then press the knob to confirm;
4. Select ← to return main menus.

**Note:**

- The function parameters are usually adjusted only during the initial installation.
- User can finely adjust the sensitivity of the current microphone through the wireless microphone, and the cursor indicates the actual sensitivity.

### 4.4.2 Line Out Vol.

Adjust the volume of Line out, range:  $-\infty$  (mute), -30 dB to 0 dB.



Rotate the knob to adjust the volume, then press the knob to confirm and return main menus.

### 4.4.3 Phantom Power

Set up the phantom power function of MIC1/LINE1.

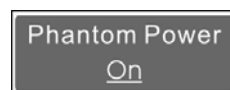

Rotate the knob to select “on” or “off”, then press the knob to confirm and return to main menus.

#### 4.4.4 Mute by IR Mic

If select “On”, the wired microphone will be mute when the digital IR wireless microphone is on.



Rotate the knob to select On or Off, then press the knob to confirm and return to main menus.

#### 4.4.5 Remote Ctrl.

User can finely adjust the sensitivity of the current microphone through the TES-560x IR wireless microphone based on the set Mic Sens. Remote Ctrl. sets the permission and adjustment range.

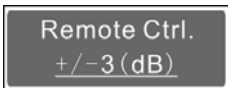

Rotate the knob to select a range ( $\pm 3$  dB,  $\pm 6$  dB,  $\pm 9$  dB) or off, then press the knob to confirm and return main menus.

#### 4.4.6 Carrier Select

Select the carrier of system.



Rotate the knob to select a group of carrier, then press the knob to confirm and return main menus.

#### Note:

☞ Please use the receivable frequencies changing function restrainedly for keeping normal use

#### 4.4.7 Language

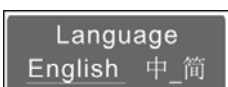

Rotate the knob to select a language and then press the knob to confirm.

#### 4.4.8 Network

Set the IP address, subnet mask, gateway of the system.

##### ■ IP address



1. Rotate the knob to switch between the four numbers, and press the knob to select a number;



2. Rotate the knob to adjust the value, press the knob to confirm;

3. Select  $\leftarrow$  to return main menus.

##### ■ Subnet mask and gateway

The same chronological order as for the “IP address” set up.

#### 4.4.9 Auto Fade

Select the trigger signal sources of LINE IN 1/2/3 fade. Volume of LINE IN 1/2 will be reduced 18 dB after triggering.

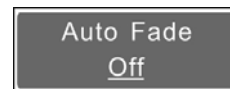

1. Press the knob to enter the setting interface;

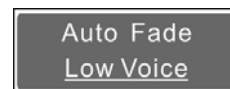

2. Rotate the knob to select a fade way among Off, Low Voice, High Voice and IR Signal.

■ **Voice trigger:** LINE IN audio fade will be trigger when voice reaches the certain sound pressure. It includes Low Voice and High Voice.

■ **IR signal:** LINE IN audio fade will be controlled by microphone on/off.

3. Press the knob to confirm.

#### 4.4.10 FB Suppress

Set a FB (feedback) suppress level.



Rotate the knob to select a level among Off, High and Low, then press the knob to confirm after adjusting.

**Note:**

☞ The higher the FB suppress level, the better the FB suppress effect. But too high level may have an impact on the sound quality, so please select the reasonable FB suppress.

#### 4.4.11 Factory Reset

Set whether to restore production settings.



Rotate the knob to select "Yes" or "No".

#### 4.4.12 About

Display the version of the device.

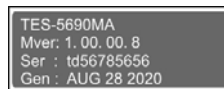

#### 4.4.13 Return

Press the knob to return to the Initial interface.

#### 4.4.14 Protection

**Alarm function:** activated when a high level being input to the phoenix interface or the controllable microphone or central control system send an alarm signal to the main unit, the LCD displays "Alarm On!".

## 4.5 USB LINK

TES-5690 series main unit built-in USB Audio (2 channels, 16bit, 48 kHz) which can be connected to the computer through USB cable (software requirement: Win7 or higher) for digital audio input/output. The main unit cooperating with the TES-560x microphone can realize remote PPT click function. In the following we take Win7 system as an example to introduce the function and operation of the USB LINK.

### 4.5.1 Installation of USB LINK

Once the TES-5690M main unit connects to a PC, the TES-5690M LINK will be detected automatically. If it is connected for the first time, the USB device driver will be recognized and installed automatically, as shown in the following figure:



Figure 4.3 Installing USB LINK

After successful installation, the user can check the information of TES-5690M USB LINK from “Device Manager”, as shown in the following figure

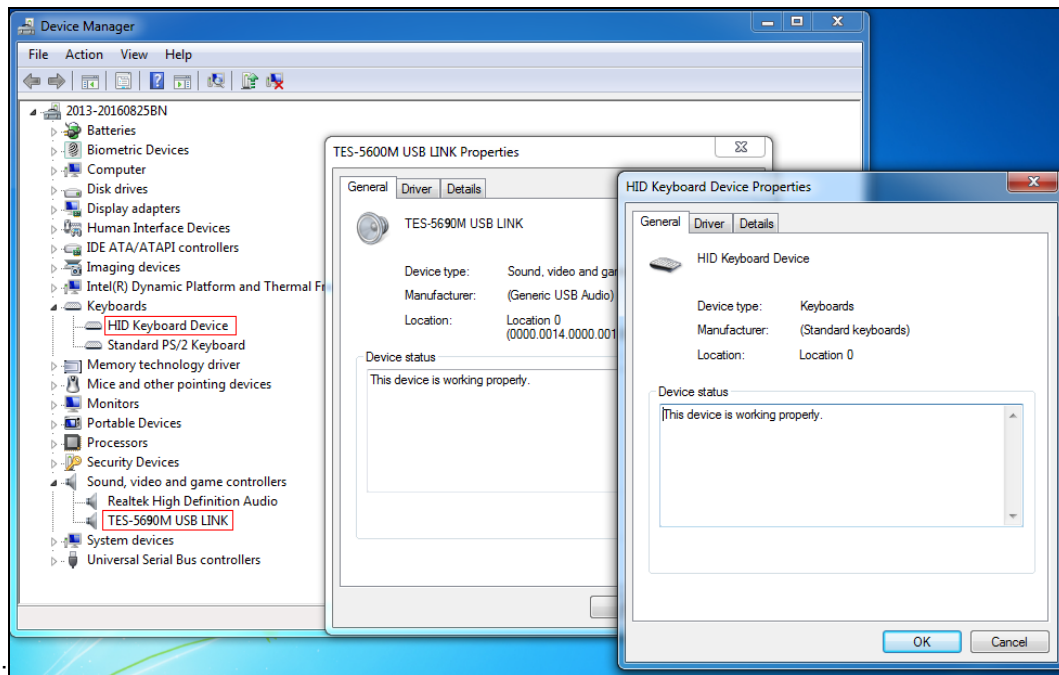

Figure 4.4 Information of USB LINK

### 4.5.2 Remote PPT click function

The TES-5690M series main unit cooperates with the TES-560x series microphone to realize remote PPT click function. See [5.4](#).

### 3.5.3 Digital Laser Pointer

When TES-5690M series main unit is connected to a PC via B-type USB interface, and the TSW-5608B digital laser pointer setting tool runs on the PC, digital laser pointer function can be realized with TES-5608N. Please refer to [6.4.10](#) for the operation details.

#### 4.5.4 Digital audio input

The TES-5690M main unit can be connected to the computer for digital audio input. Please adjust and test the TES-5690M USB LINK to a suitable volume when using for the first time. Adjust method: open the control panel-sound (or right click the volume icon on the taskbar and select sound), and select the speakers (TES-5690M USB LINK) and modify its setting in the Playback dialog box, as shown in the following figure:

#### 4.5.5 Digital audio output

When the TES-5690M main unit is connected to computer with USB cable, lossless sound can be recorded during class on computer. Using the recording software or the third party communication software, such as recorder, Skype and so on, functions like recording, remote instruction, remote communication can be implemented.

Please adjust and test the TES-5690M USB LINK to a suitable volume when first using. Adjust method: open the control panel-sound (or right click the volume icon on the taskbar and select sound), and select the Microphone (TES-5690M USB LINK) and modify its setting on the Recording dialog box. Shown as the following figure:

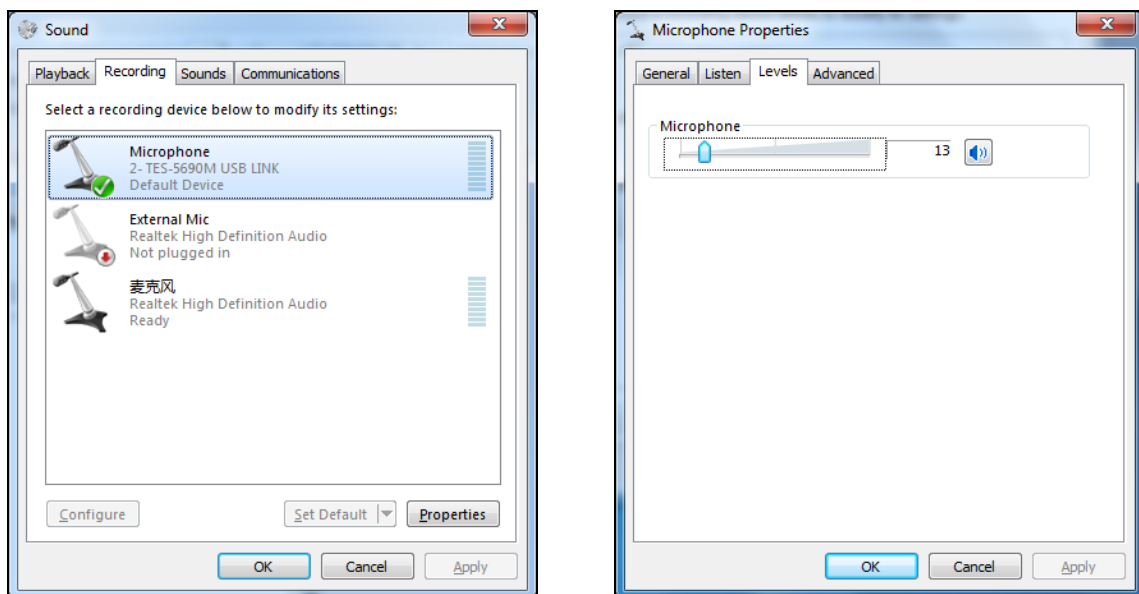

Figure 4.5 Adjusting microphone volume

**Note:**

- ☞ High volume may lead to distortion, user can confirm a suitable volume by recording and playback when necessary;
- ☞ When recording under compressed format such as MP3, the audio quality may be affected if using unsuitable sampling rate or resolution so it is suggested to select 44.1kHz or its multiple for the sampling rate and 16 bit for the resolution;
- ☞ In "Microphone Properties- Listen", please disable "Listen to this device" (TES-5690M USB LINK) to avoid echo.
- ☞ Please select the TES-5690M USB LINK as the current device on recording or communication. Usually, TES-5690M USB LINK will be automatically activated after connecting to the computer, instead of the default audio device. If there is error in recording, please select the sound card manually in case there is a mistake in the setting.



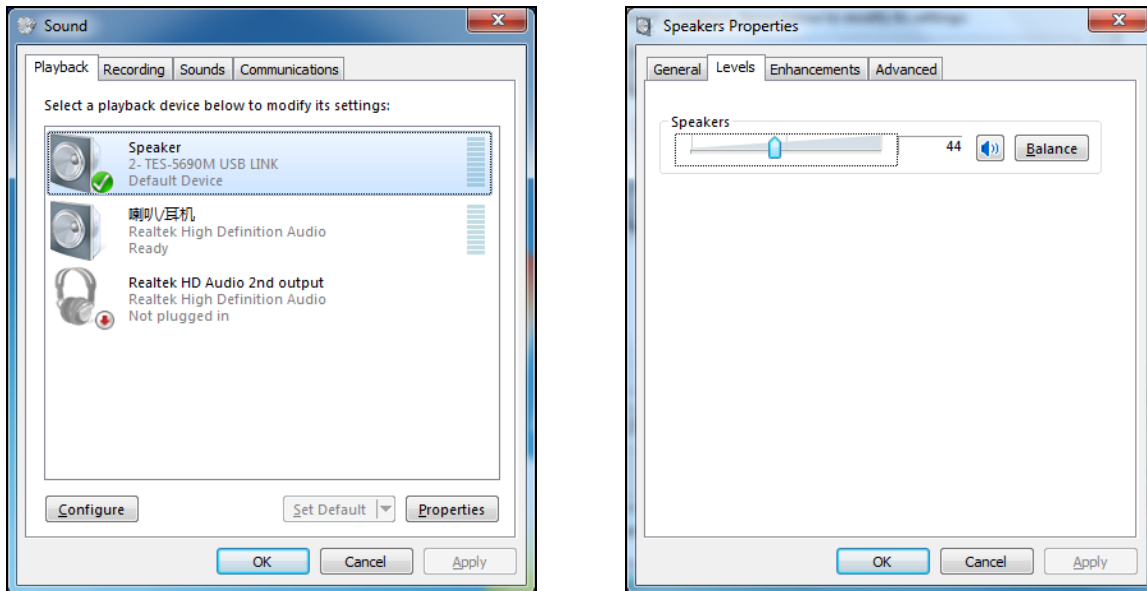

Figure 4.6: Adjusting playback volume

**Note:**

Please select the TES-5690M USB LINK as the current device on playback. Usually, TES-5690M USB LINK will be activated after connecting to the computer, instead of the default audio device. If there is an error in playback, please select the TES-5690M USB LINK manually in case there is a mistake in audio device selection. Take the Media Player as an example to show the audio device selection:

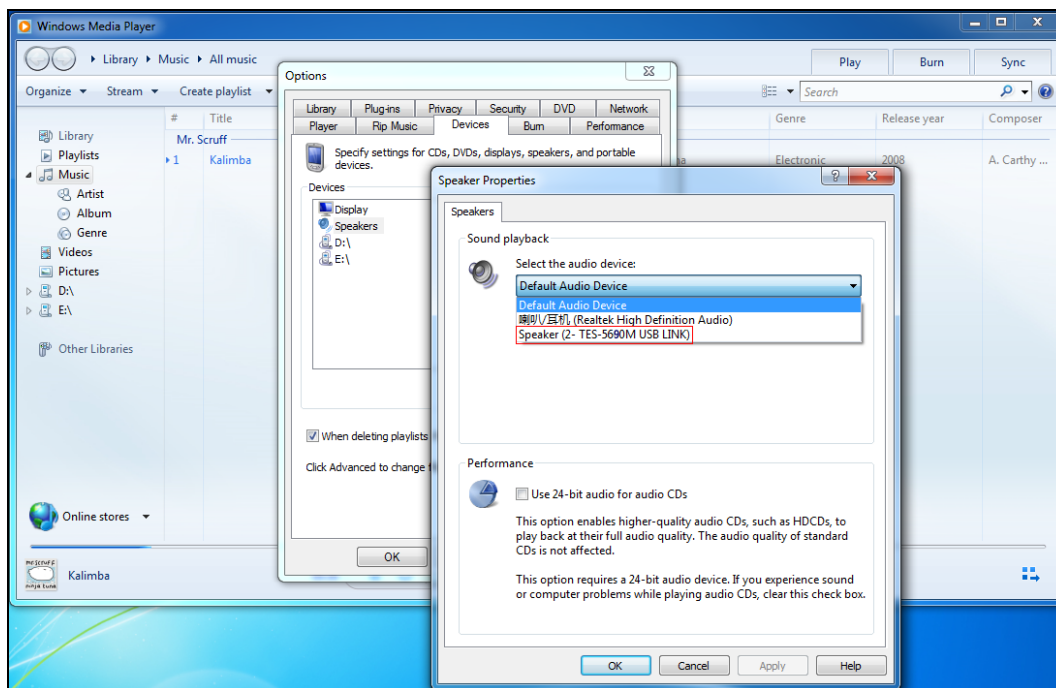

Figure 4.7 Audio device selection

## 4.6 Webserver

When the ETHERNET interface of TES-5690 is connected to PC through switch, input the IP address in the address bar of the browser to open the Web server interface. As shown below:

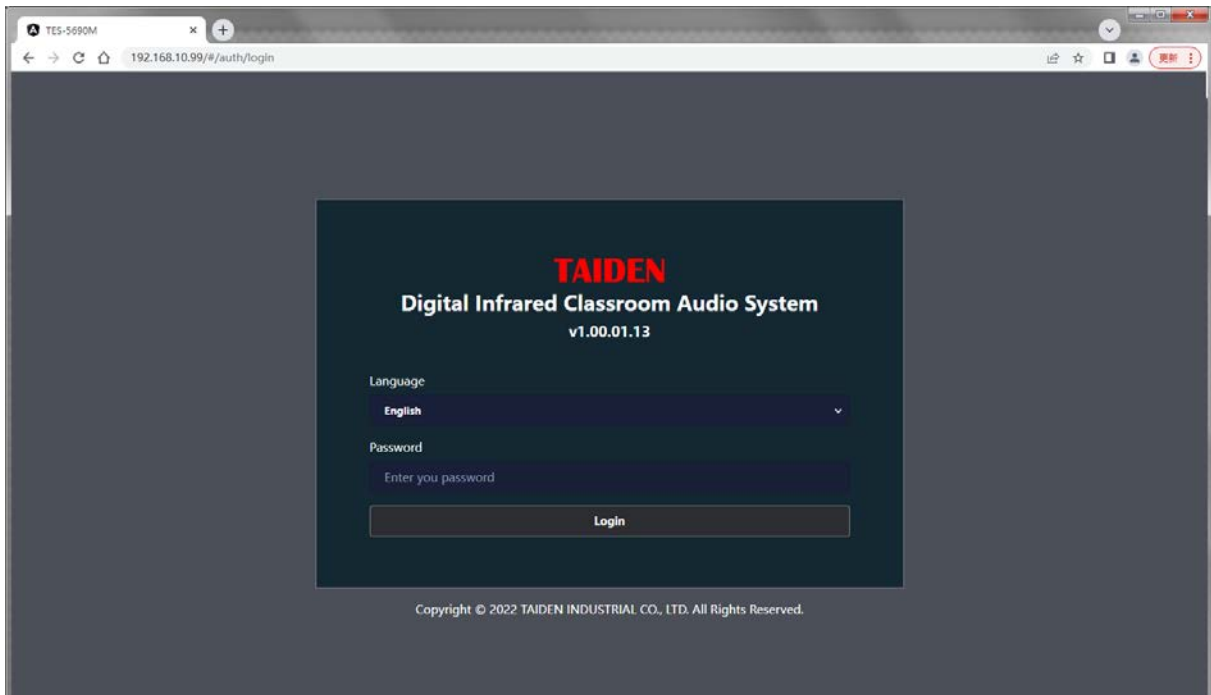

Figure 4.8 Login

Select the interface language and password (default password is TAIDEN-5690), then click 'login' button to enter the main interface.

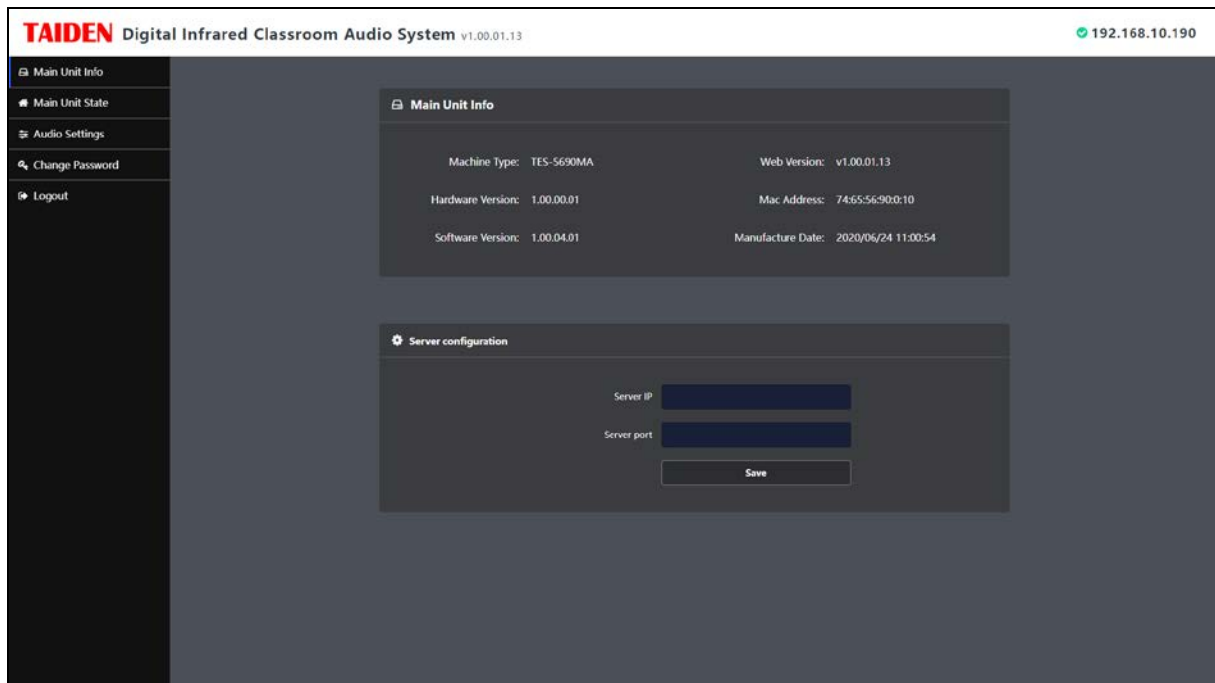

Figure 4.9 Main interface (Main Unit Info.)

On the left side of the webserver, it shows navigation menu, including 5 menu items: Main Unit Info., Main Unit State, Audio Settings, Change password and Logout; Click the navigation menu and it shows the corresponding info. on the right side:

(1) Main Unit Info.

Main unit Info. is the default main interface, and click navigation menu on the left side can also enter the interface as below:

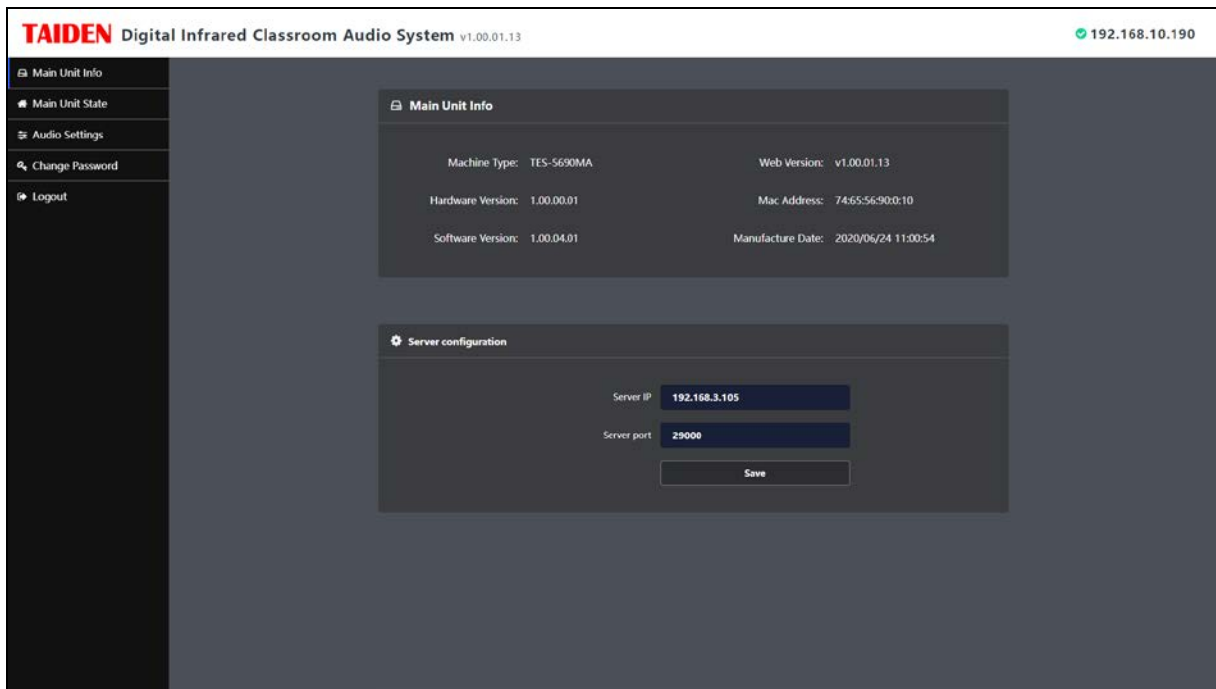

Figure 4.9 Main Unit Info.

- **Main Unit Info.** : show information of the main unit, including machine type, hardware version, software version, web version, Mac address and manufacture date
- **Server configuration:** Enter IP address and communication port of the server of Smart Classroom System Management Platform, then click 'save' button.

(2) Main Unit State

The interface includes the phantom power, infrared microphone, carrier settings and infrared remote control settings.

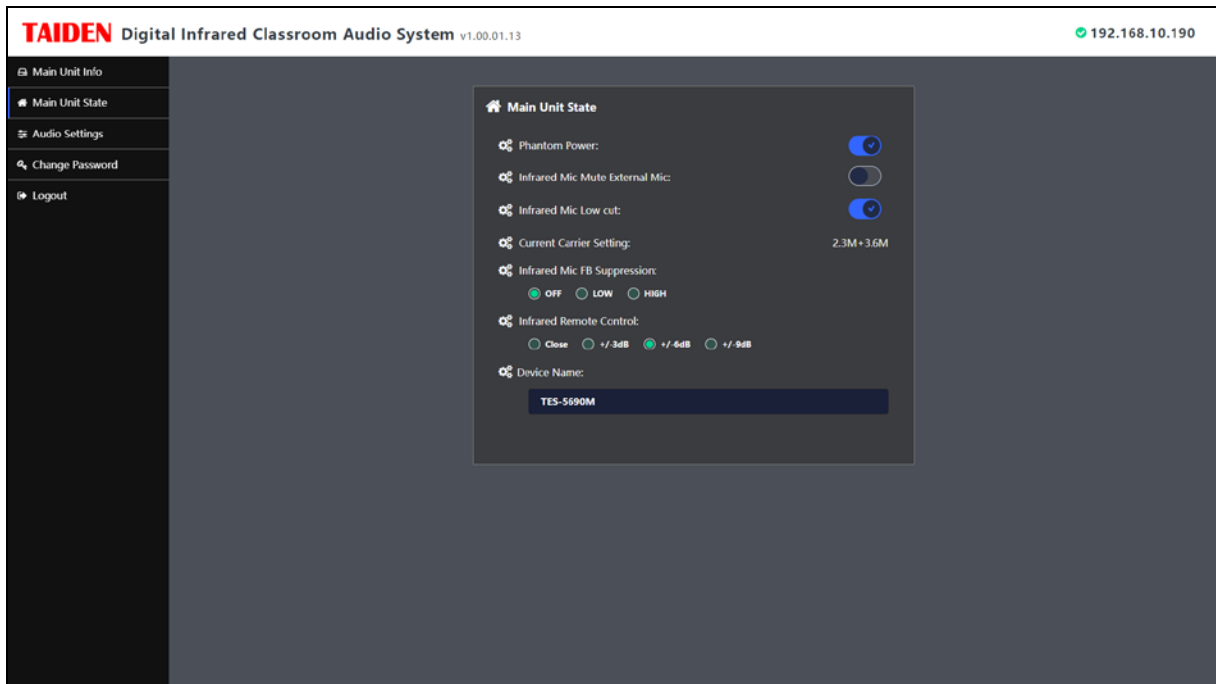

Figure 4.9 Main Unit State

- **Phantom Power:** set the phantom power supply function of MIC1/LINE1 interface;
- **Infrared Mic Mute External Mic:** if it is enable, the microphone or USB microphone will be mute when the infrared microphone is turned on;
- **Infrared Mic Low cut:** turn on / off the low cut function of the infrared microphone;
- **Current Carrier Setting:** displays the current frequency;
- **Infrared Mic FB Suppression:** with OFF/ LOW / HIGH three steps. The higher the FB suppress level, the better the FB suppress effect. But too high level may have an impact on the sound quality, so please select the reasonable FB suppress;
- **Infrared Remote Control:** the user can fine-tune the current microphone volume by TES-560x the digital infrared wireless microphone on the basis of the set microphone volume. The fine-tuning range is Close / $\pm 3$  dB/ $\pm 6$  dB/ $\pm 9$  dB;
- **Device Name:** set the name of the current device.

(3) Audio Settings

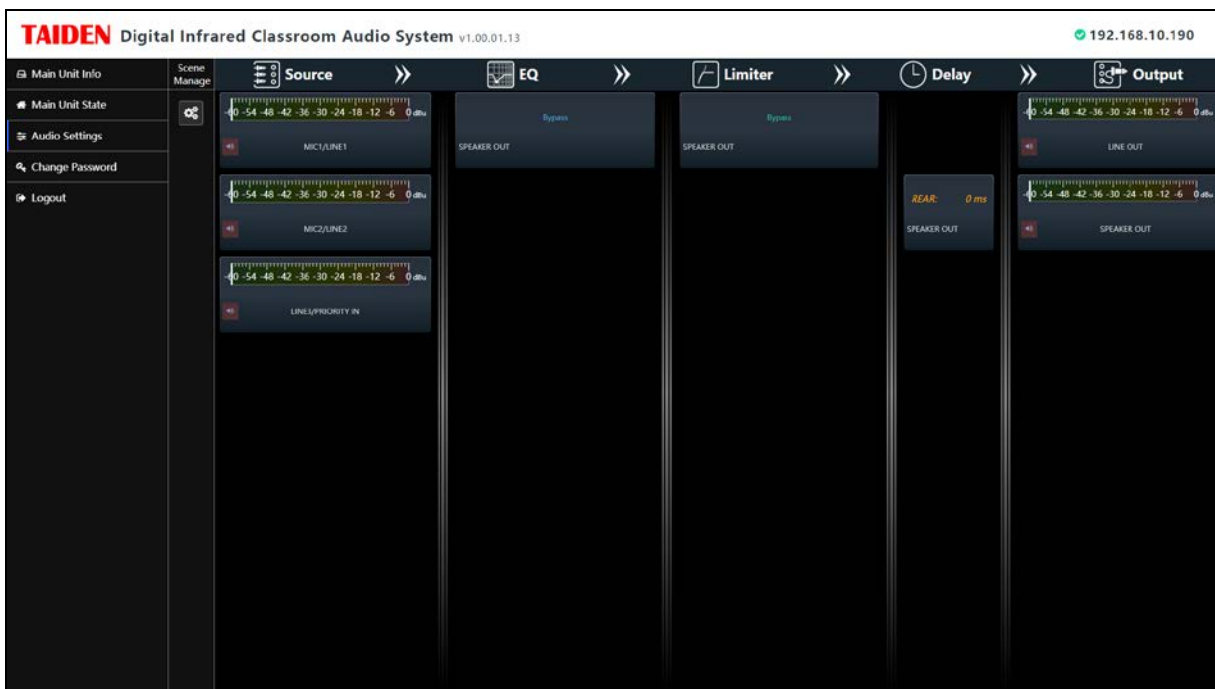



Figure 4.10 Audio Settings

- **Scene Manage:** Click  button and it will pop up Scene Settings window:

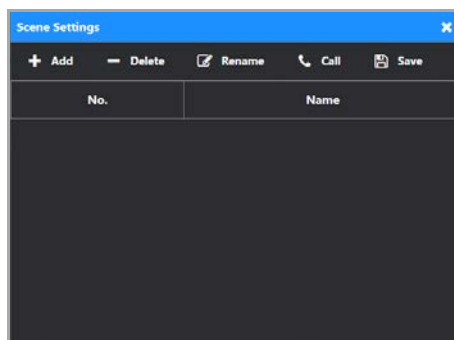

Figure 4.11 Scene Settings

The Scene Settings window shows a scene list (support up to 4 scenario), and 5 setting operations, including add, delete, rename, call, parameter save:

**Add:** Click '+ Add' button to create a scene, define its name and click 'Save' button, then the scene list add a record.

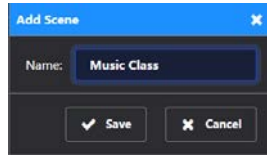

Figure 4.12 Add Scene

**Delete:** Choose a record from the scene list and click ' – Delete' button , the record will be deleted immediately;

**Rename:** Choose a record from the scene list and click ' Remane' button, then edit the name for the scene;

**Parameter save:** Choose a record from the scene list and click ' Save' button, all audio parameter will be store in the scene, and can be recalled any time.

**Recall:** Choose a record from the scene list and click ' Recall' button, all audio parameter stored in the scene will be effective immediately.

- **Source:** set the parameters of input audio, including three audio sources MIC1/LINE1、MIC2/LINE2 and LINE3/PRIORITY IN. Click the icon on the left horn of an audio source channel to mute it. Click on an audio source channel to enter its audio parameter adjustment interface:

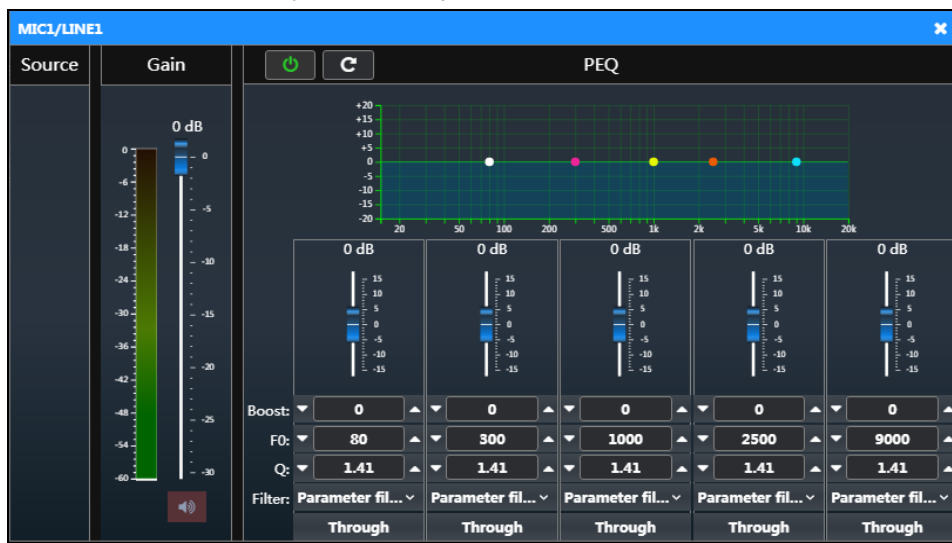

Figure 4.13 Audio parameter adjustment for souce MIC1/LINE1

Adjustable the input gain (range: mute, 0 to 60 dB). Click “” to adjust the PEQ (parameter equalization).

The channel frequency response curve displays on the interface. There are five filters available, the type (parameter filter, low shelf, elevated), quality factor (Q), frequency point (F0) and amplification low cut (Boost) of each filter can be set. The default is "through" and the filter cannot be set when "Through" is selected. Click “” to restore default settings and the curve is shown as a straight line now.

- **EQ:** click to enter the GEQ settings of SPEAKER OUT.



Figure 4.14 GEQ settings of SPEAKER OUT

Click “” can adjust the GEQ, support 31 graphical equalization, drag the push of frequency to adjust the equalization parameters. Click “” to restore the default settings and the curve is displayed as a straight line now.

- **Limiters:** click to enter the pressure limiter settings of SPEAKER OUT.



Figure 4.15 Limiter of SPEAKER OUT

Click "🔌" to adjust the pressure limit, the Threshold, Attack Time and Decay Time can be set.

- **Delay:** click to enter the delay settings of SPEAKER OUT, range :0 to 30 ms.

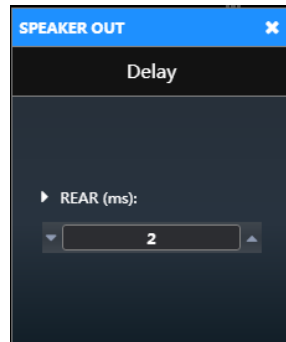

Figure 4.16 Delay of SPEAKER OUT

- **Output:** Set the output volume, including LINE OUT and SPEAKER OUT. Click 🗣️ or 🔴 button to mute / cancel mute an audio output channel, and click the output channel to enter its volume adjustment interface, drag the push to adjust the volume, range :0 to -30 dB.

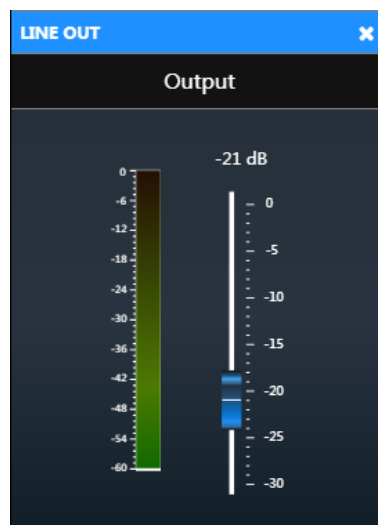

Figure 4.17 Volume adjustment interface

## Chapter 5 Digital infrared wireless microphone

### 5.1 Overview

TES-560x series digital infrared wireless microphone is ergonomically compact and of elegant design, can be held in hand hung around the neck via a nice strap or fit into the shirt pocket. Functions can be realized: speak, frequency selection, remote volume control, etc.

#### Types:

##### **TES-5602A\_G**

Digital Infrared Wireless Microphone (handheld type, gray, with rechargeable battery, excl. adapter)

##### **TES-5604N\_W**

Digital Infrared Wireless Microphone (white, built-in rechargeable lithium battery, with laser pointer, excl. adapter, used with TES-5600NS\_W neck lanyard or TES-5600CLP clip)

##### **TES-5608AN**

Digital Infrared Clipper Microphone

##### **TES-5608BN**

Digital Infrared Wireless Microphone Demonstrator (with digital laser pointer, built-in rechargeable lithium battery, can be used with charging base with electronic lock)

##### **TES-5608CN**

Digital Infrared Wireless Microphone Demonstrator (with laser pointer, built-in rechargeable lithium battery, can be used with charging base with electronic lock)

## 5.2 Functions and indicators

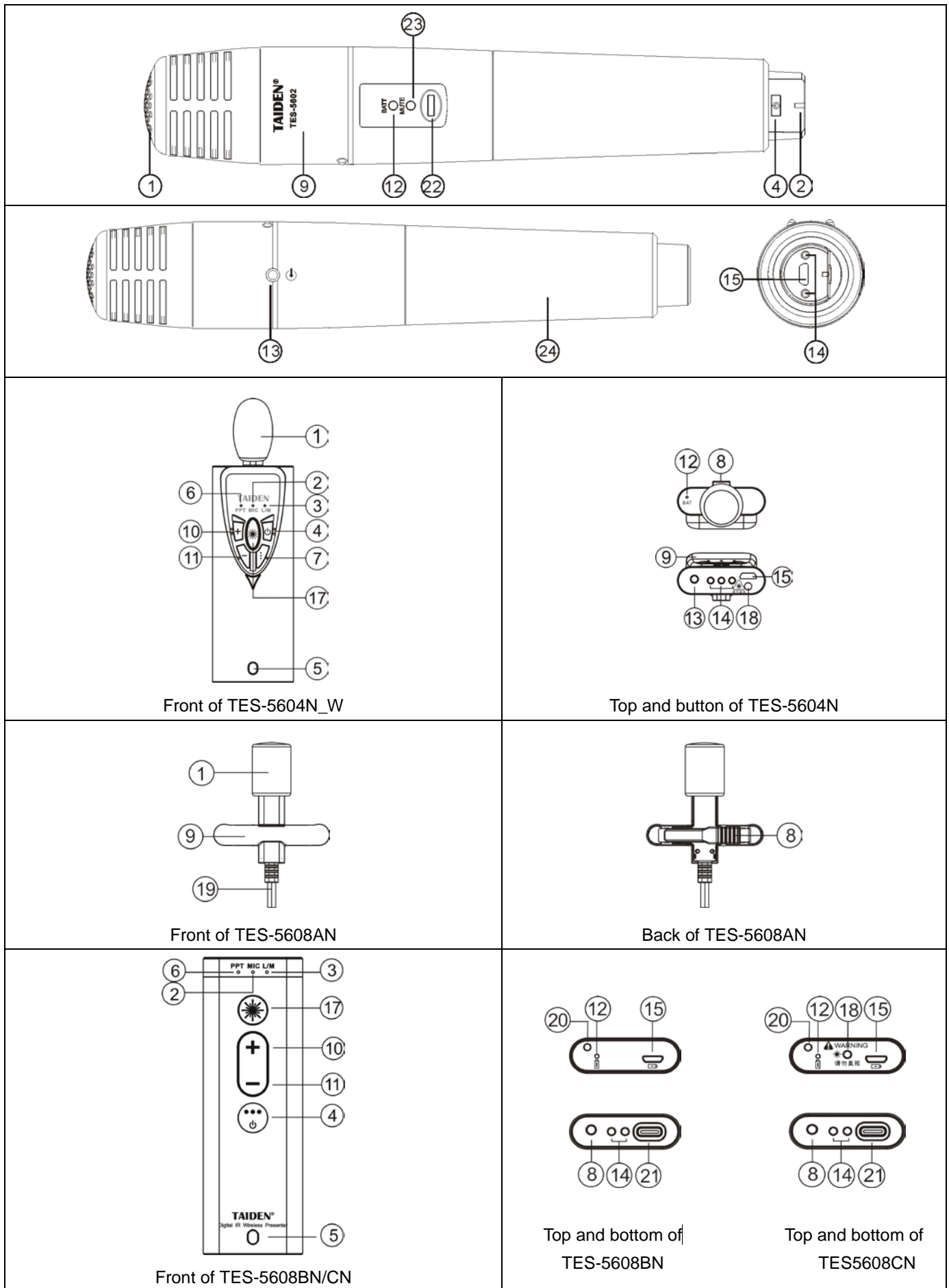

Figure 5.1 Digital infrared wireless microphone



**Figure 5.1:**

**1. Microphone**

**2. MIC indicator**

**3. L/M indicator**

- For adjusting the parameters

**5. Microphone on/off button**

**Note:**

☞ It can be used with other keys to adjust parameters (only TES-5608BN/CN).

**5. Hole of electronic lock**

**6. PPT mode indicator**

- Turn red when in PPT mode;
- An indicator for parameter adjustment.

**7. “...” button**

- Switch between PPT mode and MIC mode;
- Adjusting parameters with other button

**8. Hanging piece slot**

**9. IR transmitter**

**Note:**

☞ To guarantee smooth signal transmission, please do not block this part in any case.

**10. Adjust button (+)**

- Increase the volume of the MIC;
- Page up of the current PPT

**11. Adjust button (-)**

- Reduce the volume of the MIC;
- Page down of the current PPT.

**12. Battery indicator**

**13. Auxiliary audio input (AUDIO IN, Ø 3.5 mm)**

- Connect to external MIC;
- Connect to auxiliary audio device (LINE IN)

**14. Charging contacts**

**15. Micro USB interface**

- Connect to TES-ADP5V adapter for charging;
- For upgrade

**16. “F” button**

- Switch between PPT mode and MIC mode;
- Adjusting parameters with other button

**17. Laser pointer button**

- Press and hold on it to open the laser pointer, and release to close it (TES-5608CN only);
- Press and hold on it to display the flying mouse and the flying mouse can move on the projection screen. When you release it, the flying mouse is still (TES-5608BN only);
- Double click the button to switch the flying mouse style of the digital laser pointer (TES-5608BN only);
- Be used with other keys to adjust parameters (only TES-5608BN/CN).

**18. Laser transmitter**

**Note:**

☞ Do not look directly at the laser transmitter.

**19. Connecting cable (with USB port)**

- Connect to TES-5608BN/CN for audio transmission;

**20. Neck lanyard threading hole**

**21. Type C USB interface**

- Connect to TES-5608AN microphone for audio transmission;

**22. Mute**

- Press to mute/cancel mute the microphone.

**23. Mute indicator**

**24. Battery slot**

### 5.3 Infrared light coverage

Infrared light is directional invisible light. Infrared wireless microphone gets best sensitivity when it directly faces a receiver. The infrared transmitter on TES-560x series digital infrared wireless microphone is designed to be at its best position to guarantee maximum emission angle and to ensure the most effective infrared signal transmission.

The vertical transmission angle is  $90^\circ$ , and the horizontal transmission angle for TES-5604N\_W and TES-5608AN is  $120^\circ$ , while for TES-5602A\_G is  $360^\circ$ .

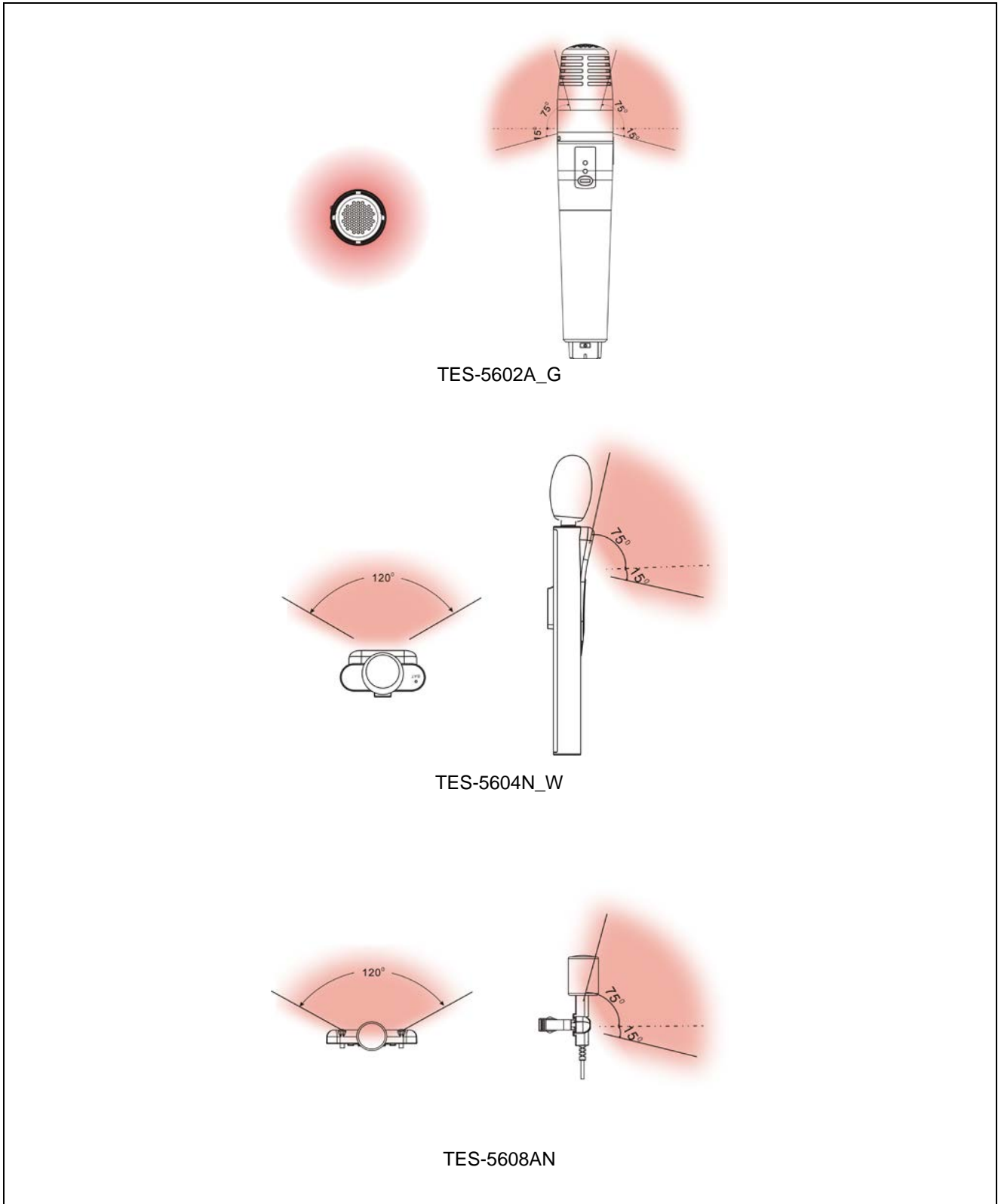

Figure 5.2 Coverage of digital IR wireless MIC

## 5.4 Operation

### 5.4.1 TES-5602A\_G (handheld type)

TES-5602A\_G handheld type digital infrared wireless microphone combines speaking, mute, and working mode setting all in one. Other peripheral devices like MP3 player and so on also can be connected to implement more comprehensive functions.

#### 1. Mic. On/Off and frequency channel selection

- Press the Power (Mic.) ON/OFF button to turn on/off the microphone, the power indicator will be turned on and the **BATT** indicator indicates battery status:

Battery status	BATT Indicator
Full	Green (on)
Enough	Yellow (on)
Lack	Red (on)

- TES-5602A\_G offers 4 frequency channels: 1.667 MHz, 2.333 MHz, 3.0 MHz and 3.67 MHz.

#### Frequency channel selecting:

- Rotate and demount the battery slot to find out the frequency switch shown as follows:

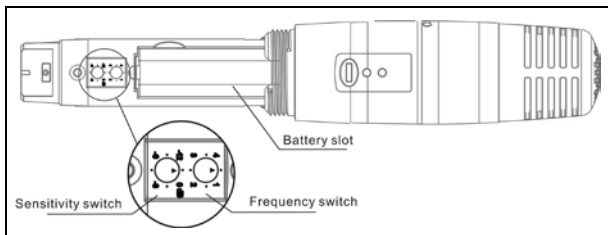

Figure 3.7 Battery slot of handheld microphone

- Select a frequency channel by pressing the frequency switch. The number and its corresponding frequency are as follows:

No.	1	2	3	4
Frequency	1.667 M	2.333 M	3.0 M	3.67MHz

#### Note:

- Make sure the arrow points to the dot.

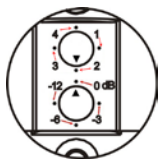

As the figure shown, The frequency of TES-5602A\_G is 2.33 M and Sensitivity is 0

- Mic will reboot automatically and apply the frequency channel.

#### 2. External audio input

External audio devices (such as CD player) can be connected via the  $\phi$  3.5 mm AUDIO IN interface and the microphone will be muted automatically;

#### 3. OWN mute control

Press the "MUTE" button to enable or disable the mute function. The mute control is available for the microphone and external audio input at the same time.

#### 4. Sensitivity setting

Rotate and demount the battery slot and select a sensitivity by sensitivity switch (see to figure 3.7). There are 4 levels for selection: -12 dB, -6 dB, -3 dB and 0 dB.

#### Note:

- Sensitivity is invalid for AUDIO IN.

#### 5. MEMS accelerometer setting

TES-5602A\_G has a built-in gravity sensor (MEMS accelerometer), which is equipped to detect the spatial location of the handheld microphone, enabling intellectual control of the infrared emission angle. This ensures efficient coverage of the infrared signal and can prolong the battery runtime. Setting **Steps** is as below:

- Press and hold simultaneously "MUTE" and power buttons for more than 2 seconds, the MUTE indicator will be turned on and the **BATT** indicator will cycle flash two times in the order of red-yellow-green;
- Switch the mode by the MUTE button. The **BATT** indicator indicates the current mode :

Mode	BATT indicator
MEMS accelerometer off	Yellow
MEMS accelerometer on	Green

- Press the power button to save;
- Mic will reboot automatically.

#### 6. Charging

TES-5602A\_G is powered by a rechargeable Lithium battery and it also can be charged via the USB port.

When charging, it switches to external power supply mode automatically. The BATT indicator shows status:

Charging status	BATT indicator
Charging	Green (blink)
Charged	Green (on)

#### Note:

- Please turn off TES-5602A\_G before replacing battery.

## 5.4.2 TES-5604N\_W

### 1. Mic. On/Off and frequency channel selection

- Keep pressing the microphone on/off button about 2 seconds to power on and turn on the microphone, the **MIC** indicator will be turned on and the **BAT** indicator indicated battery status:

Battery status	BAT Indicator
Enough	Off
Low	Red (blink)

- Press the microphone on/off button to turn off the microphone.
- TES-5604N\_W offers 5 frequency channels: 1.00 MHz, 1.67 MHz, 2.33 MHz, 3.00 MHz and 3.67 MHz.  
**Frequency channel selection:**
  - Press and hold the “...” and microphone on/off buttons simultaneously for more than 2 seconds in power off status. All signal indicators shall flicker in turn twice when entering frequency selection mode, and the default frequency channel is the one chosen for previous use;
  - Select a frequency channel by pressing the “...” button. The signal indicators show different frequency channel:

Frequency	BAT	PPT	MIC	L/M	BAT
1.0 MHz	ON				ON
1.67 MHz	ON	ON			ON
2.33 MHz	ON		ON		ON
3.0 MHz	ON			ON	ON
3.67 MHz	ON		ON	ON	ON

- Press the microphone on/off button to save and the corresponding indicator(s) will blink;
- Mic will power off automatically and please reboot it to apply the frequency channel.

#### Note:

- Microphones with the same frequency channel cannot be used in one classroom at the same time.
- The default frequency is 2.33 MHz.
- The maximal number of active microphones is determined by the type of the system.

### 2. Volume control

- Press the “...” to select volume control function, the MIC indication will turn on;
- Adjust the volume by the “+/-” buttons. The volume will be increased/decreased (**MIC** indicator flashes) until it reaches the maximum/minimum.

### 3. Auto. shut down mode

When enable the auto. Shut down mode, TES-5604N\_W will turn off automatically if no speaking voice is detected within 15 minutes.

#### Steps:

- Press and hold simultaneously the “+” and the microphone on/off buttons for more than 2 seconds, all signal indicators shall flicker in turn twice;
- Switch the mode by pressing the “...” button. The signal indicators show the current working mode :

Auto. shut down mode	BAT	PPT
Off	ON	
On	ON	ON

- Press the microphone on/off button to confirm;
- Mic. will power off automatically and please reboot it to apply the setting.

### 4. PTT mode

When the PTT (push to talk) mode is enabled, user can press and hold the “...” button to talk. The “...” button can only used for PTT now.

The mode is disabled by default.

#### Steps:

- Press and hold simultaneously the “-” and the microphone on/off buttons for more than 2 seconds, all signal indicators shall flicker in turn twice;
- Switch on the mode by pressing the “...” button, The signal indicators show the current working mode:

PTT mode	BAT	PPT
Off	ON	
On	ON	ON

- Press the microphone on/off button to save.

## 5. Audio input

External audio devices (such as MP3) or microphone can be connected via the Ø3.5 mm AUDIO IN interface and the microphone will be muted automatically. The volume from AUDIO IN can be adjusted by the “+/-” buttons.

Keep pressing the “...” button to adjust audio input mode, **L/M** indicator indicates the current working mode:

L/M indicator	Input mode
OFF	MIC IN
ON	LINE IN

## 6. PPT click Function

Remote control of PowerPoint click can be realized, when the main unit has USB Link function and connects to PC.

### Steps:

- Press the “...” button to switch to PPT mode, and the PPT indicator turns red
- Press the “+/-” button to realize the PPT click function

### Note:

☞ The PPT mode is off by default.

## 7. Laser pointer

TES-5604N\_W has a laser pointer. Press and hold on the laser pointer button “” to turn on the laser pointer, and release it to turn it off.

## 8. Charging and power supply

TES-5604N\_W microphone is equipped with built-in Lithium battery, which can be charged via USB port, TES-5604N\_W also can be charged on charging station. When charging, microphone shut down automatically and the BAT indicator indicates the charging status:

Charging status	BAT indicator
Charging	Green (blink)
Full	Green (on)
Error	Yellow (blink)

## 9. Fitting the microphone

Put the hanging piece of the TES-5600NS series neck lanyard into the slot, adjust the length of the neck lanyard to find a suitable position for the speaker and for a perfect sound pickup.

TES-5604N\_W can be used with the TES-5600CLP clip. User can disassemble the clip through the screw in the middle and change the direction of the clip.

### Note:

☞ The pocket clip must be put outside of the shirt pocket.

### 5.4.3 TES-5608N

#### 1. Mic. On/Off and frequency channel selection

- Keep pressing the microphone on/off button about 2 seconds to power on and turn on the microphone, the MIC indicator will be turned on and the **BAT** indicator shows battery status:

Battery status	BAT Indicator
Enough	Off
Low	Red (blink)

**Note:**

- TES-5608BN/CN can only be turned on when it is connected to TES-5608AN.

- Press the microphone on/off button to turn off the microphone.
- TES-5608N offers 5 frequency channels: 1.00 MHz, 1.67 MHz, 2.33 MHz, 3.00 MHz and 3.67 MHz.

**Frequency channel selection:**

- Press and hold the laser pointer ("\*") and microphone on/off button simultaneously for more than 2 seconds in power off status. All signal indicators shall flicker in turn twice when entering frequency selection mode, and the default frequency channel is the one chosen for previous use;
- Select a frequency channel by pressing the laser pointer (\*) button. The signal indicators show different frequency channel:

Frequency	BAT	MIC	PPT	L/M
1.00 MHz	ON			
1.67 MHz	ON		ON	
2.33 MHz	ON	ON		
3.00 MHz	ON			ON
3.67 MHz	ON	ON		ON

- Press the microphone on/off button to save and the corresponding indicator(s) will blink;
- Mic will power off automatically and please reboot it to apply the frequency channel.

**Note:**

- Microphones with the same frequency channel cannot be used in one classroom at the same time.
- The default frequency is 2.33 MHz.
- The maximal number of active microphones is determined by the type of the system.

#### 2. Volume control

Adjust the volume by the "+/-" buttons. The volume will be increased/decreased (**MIC** indicator flashes) until it reaches the maximum/minimum.

#### 3. Auto. shut down mode

When enable the auto. Shut down mode, TES-5608N series will turn off if no speaking voice is detected within 15 minutes.

**Steps:**

- Press and hold the "+" and the microphone on/off buttons simultaneously for more than 2 seconds, all signal indicators shall flicker in turn twice;
- Switch the mode by pressing the laser pointer button ("\*"). The signal indicators show the current working mode :

Auto. shut down mode	BAT	PPT
OFF	ON	
ON	ON	ON

- Press the microphone on/off button to confirm;
- Mic. will power off automatically and please reboot it to apply the setting.

#### 4. Audio input

External audio devices (such as CD) can be connected via the Ø3.5 mm AUDIO IN interface and the microphone will be muted automatically.

#### 5. PPT click Function

Remote control of PowerPoint click can be realized, when the main unit has USB Link function and connects to PC.

**Steps:**

- Press the mic. ON/OFF button to switch to PPT mode, and the **PPT** indicator turns red;
- Press the "+/-" button to realize PPT click function.

**Note:**

- The PPT mode is off by default.

## 6. Laser pointer

TES-5608CN have a laser pointer. Press and hold on the laser pointer button "☀" to turn on the laser pointer, and release it to turn it off.

## 7. Digital laser pointer

TES-5608BN has a digital laser pointer. Press and hold on the button "☀" to display the digital laser pointer and it can move on the projection screen. When you release it, the digital laser pointer is still; double-click the laser pointer button "☀" to switch the mode of the digital laser pointer. It supports a maximum of 4 modes: magnifying glass, digital laser pointer, cross and mouse cursor.

### Notes:

- ☞ This function should be used with a main unit that supports the digital laser pointer function.
- ☞ For switching the mode of the digital laser pointer, it needs to run the **TAIDEN Presentation** software; otherwise you can only use the default "**mouse cursor**" mode. For more details, see "TAIDEN Presentation Management Software".

## 8. Charging and power supply

TES-5608BN/CN is equipped with built-in Lithium battery, which can be charged via micro USB port, and can also be charged on charging station.

When charging, microphone shut down automatically and the BAT indicator indicates the charging status:

Charging status	BAT indicator
Charging	Green (blink)
Full	Green (on)
Error	Yellow (blink)

## 9. Fitting the microphone

TES-5608AN is equipped with a clip, which can be clipped on a tie or shirt.

## Chapter 6 Wired microphone

### 6.1 Overview

#### Types:

##### **TES-5600MIC**

Wired Desktop Microphone (standard stem microphone: 60cm, optional: 50/70cm)

##### **TES-5600CSM**

Wired Desktop Microphone (standard stem microphone: 60 cm, optional: 50/70 cm; with a charging station for two TES-5604/5608N series microphones, with TES- ADP5V power adapter)

##### **TES-5600CSML**

Wired Desktop Microphone (standard stem microphone: 60 cm, optional: 50/70 cm; with a lockable charging station for one TES-5604 /5608N series microphone, can be unlocked by scanning QR code or via central control system; with TES- ADP5V power adapter)

##### **TES-5600CSMN**

Wired Desktop Microphone (standard stem microphone: 60cm, optional: 50/70cm; with a lockable charging station for one TES-5604 /5608N series microphone, can be unlocked via central control system or via network management system; support network management when used with TES-5604NSW Wireless Microphones Management Platform; with TES- ADP5V power adapter)



## 6.2 Functions and indicators

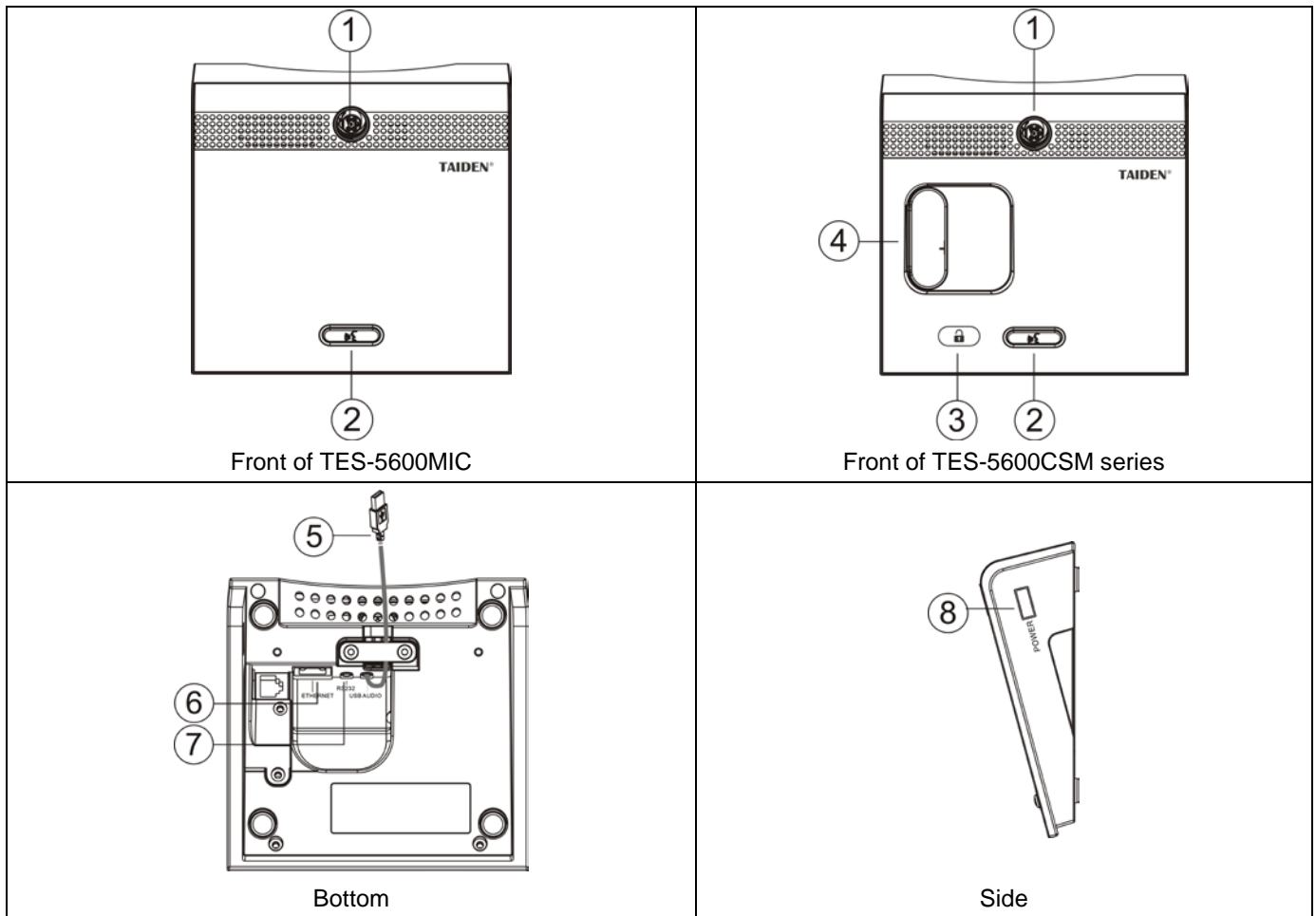

Figure 6.1 Wired microphone

**Figure 6.1:**

**1. Dismountable microphone socket**

**2. Microphone on/off button**

**3. Touch key**

- For unlocking wireless microphone

**4. Charging station**

- TES-5600CSML/CSMN with a lockable charging station for one TES-5604 /5608N series microphone
- TES-5600CSM with a charging station for two TES-5604 /5608N series microphones

**5. Audio cable**

- With an A type USB interface for connecting to the main unit to transmit audio

**6. RJ45 interface (Only for TES-5600CSMN)**

- For connecting to network, cooperate with Education Management Platform to set information of wired microphone

**7. RS232 (3.5 mm, Only for TES-5600CSMN/CSML)**

- For unlocking wireless microphone via central control system

**8. A type USB (Only for TES-5600CSM series)**

- For adapter charging

## 6.3 Installation

The wired microphone base can be fixed to the desktop through the positioning hole at the bottom. The installation cutout diagram is as below:

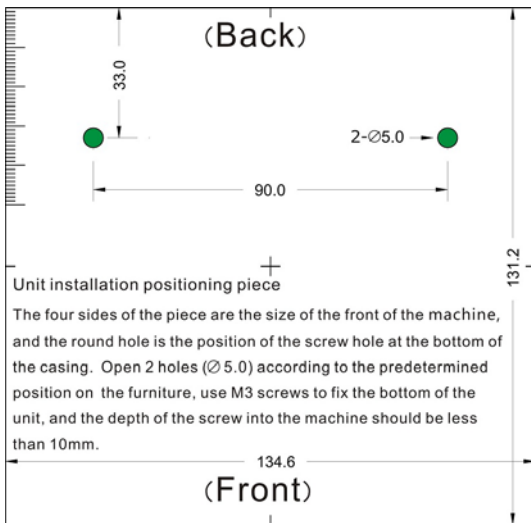

## 6.4 Operation

### 1. Mic. On/Off

The wired microphone connects to the digital infrared classroom audio system main unit via the A type USB interface, and then press the mic. on/off button to turn on/off microphone.

### 2. Microphone charging

TES-5600CSM wired microphone has two charging pockets can charge 2 TES-5604 series microphones or TES-5608BN/CN Digital Infrared Wireless Presenter

The TES-5600CSML wired microphone with 1 charging pocket can charge 1 TES-5604 series microphone or 1 TES-5608BN/CN Digital Infrared Wireless Presenter

TES-5600CSMN wired microphone with 1 charging stand can charge 1 TES-5604 series microphone or TES-5608BN/CN Digital Infrared Wireless Presenter

### 3. Unlock microphone via central control

TES-5600CSML/CSMN with a lockable charging station for TES-5604 series microphone or TES-5608BN/CN Digital Infrared Wireless Presenter, it connects to control equipment (electric relay) and central control system via the RS-232 interface, and user can unlock the microphone by press the touch key or sand a central control command.

### 4. Unlock microphone via scanning QR code

TES-5600CSML/CSMN with a lockable charging station for TES-5604 series microphone or TES-5608BN/CN Digital Infrared Wireless Presenter, user can use the "TES-5600" APP to scan QR code for unlocking microphone.

#### Note:

👉 Please scan the QR code on [www.taiden-edu.com](http://www.taiden-edu.com) to install the "TES-5600" APP.

### 5. Network control

TES-5600CSMN series wired microphone connects to network via RJ45 interface, cooperate with TES-5604NSW Classroom Audio System Management Platform to unlock wireless microphone, set information of wired microphone

## Chapter 7 Hanging microphone

### 7.1 Overview

#### Types:

##### **TES-5675T**

Hanging Microphone (Gray, round, 14mm Cardioid unidirectional microphone used to pick up the audio of the teachers' lecture)

##### **TES-5675S**

Hanging Microphone (Gray, round, omnidirectional microphone, used to pick up students' interactive audio)

##### **TES-5675H**

Hanging Microphone (black, heart-shaped unidirectionality, used to pick up the audio of the teacher's lecture)

## 7.2 Functions and indicators

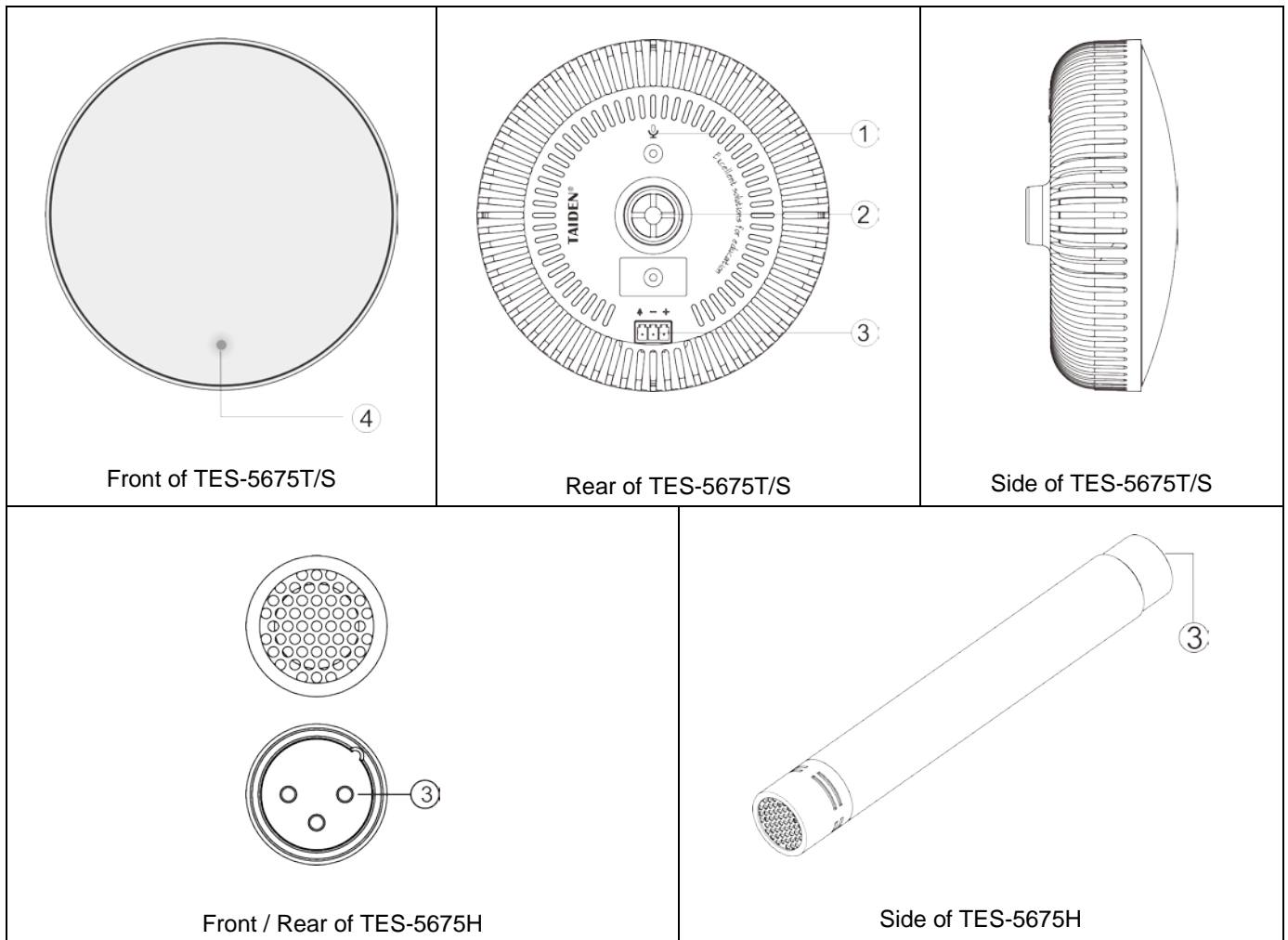

Figure 7.1 Hanging microphone

### Figure 7.1:

#### 1. Microphone identification

- Used to indicate the position of the built-in microphone

#### 2. Fixed hole

- Fix the microphone on the boom through the hole

#### 3. Connect terminal (require phantom power 48 V)

- TES-5675T/S microphone terminal is 3P Phoenix, Connect to the MIC1 / MIC2 interface of the TES-5600MAR series main unit
- TES-5675H microphone terminal is standard 3-pin XLR male XLRM, Connect to the MIC1/2 interface of TES-5600MRN / TES-5600MHN main unit

#### 4. work indicator

- The indicator light is green under normal status, is off when not connected to main unit

## 7.3 Installation

### 7.3.1 TES-5675T / TES-5675S

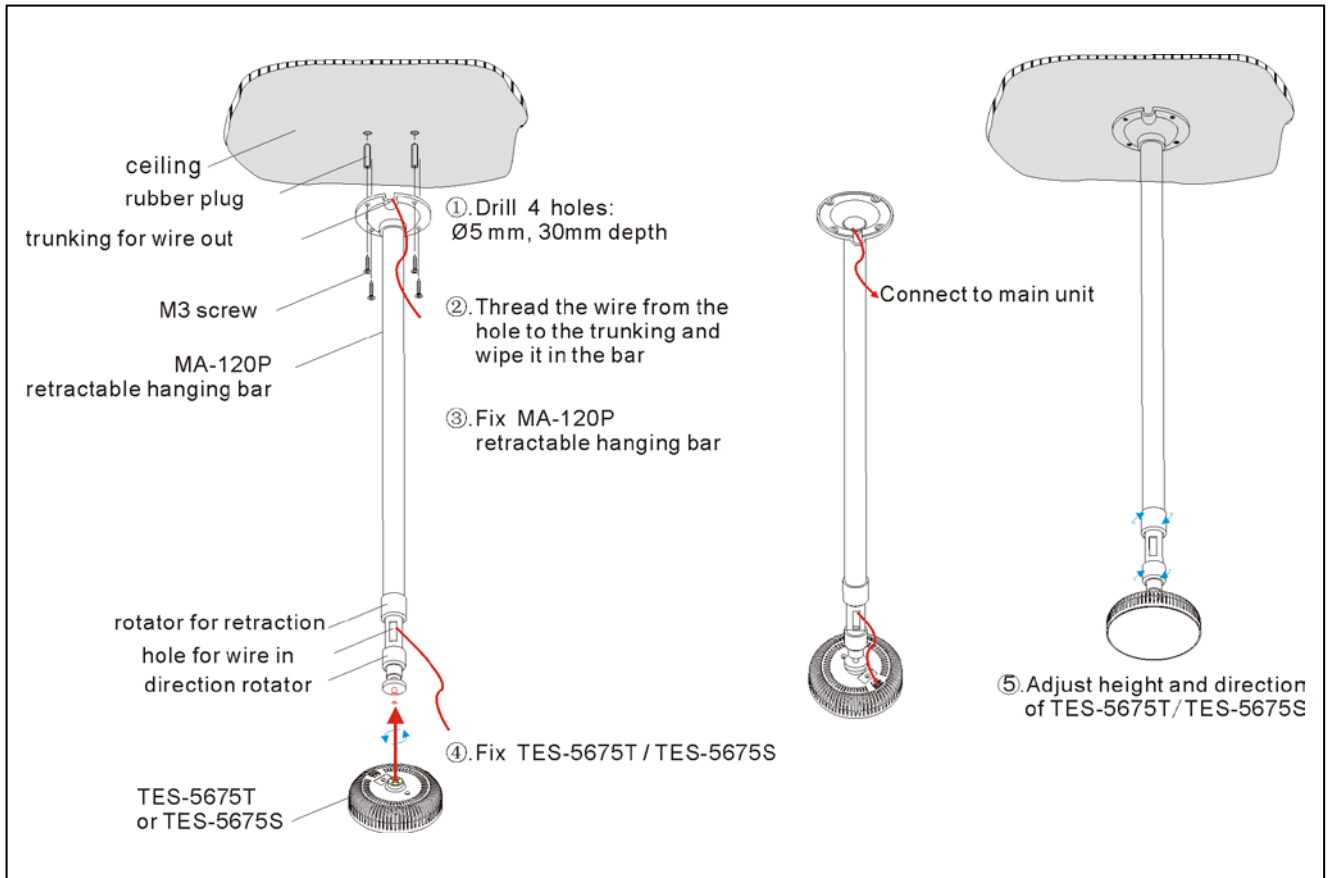

Figure 7.1 Hanging mounting for TES-5675T / TES-5675S

#### Mounting steps:

- Step 1:** Drill 4 holes ( $\varnothing 5$  mm, 30 mm depth);
- Step 2:** Thread the wire from the hole to the trunking and wipe it in the bar;
- Step 3:** Fix MA-120P retractable hanging bar;
- Step 4:** Fix TES-5675T / TES-5675S;
- Step 5:** Adjust height and direction of TES-5675T / TES-5675S

### 7.3.2 TES-5675H

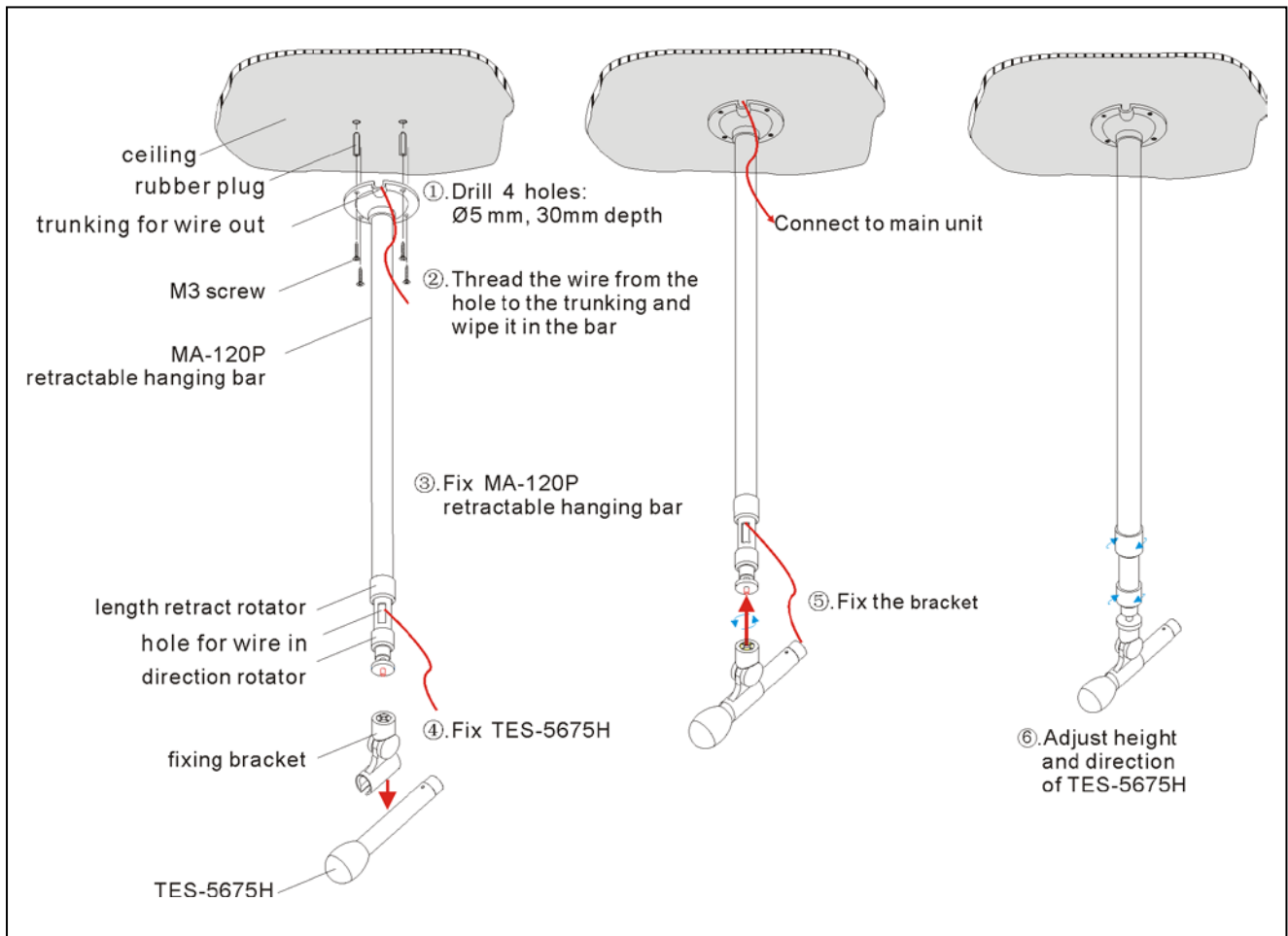

Figure 7.2 Hanging mounting for TES-5675H

#### Mounting steps:

- Step 1:** Drill 4 holes ( $\varnothing$  5 mm, 30 mm depth);
- Step 2:** Thread the wire from the hole to the trunking and wipe it in the bar;
- Step 3:** Fix MA-120P retractable hanging bar;
- Step 4:** Fix TES-5675H;
- Step 5:** Fix the bracket;
- Step 6:** Adjust height and direction of TES-5675H

## Chapter 8 Accessories

### 8.1 Power Adapter

- TES-ADP24V power adapter

Used to power for TES-5600MAU/ TES-5680BX/ TES-5600BX/ TES-5630MA connecting with  $2 \times 8\Omega/40W$  speakers



Figure 8.1 TES-ADP24V power adapter

- TES-ADP19V power adapter

Used to power for TES-5600MAU/ TES-5680BX/ TES-5600BX/ TES-5630MA connecting with  $4 \times 8\Omega/40W$  speakers; used to power for TES-5600MRN/MHN connecting with  $2 \times 6\Omega/60W$  line array column loudspeakers.



Figure 8.4 TES-ADP19V power adapter

- TES-ADP24VA power adapter

Used to power for TES-5600MRN/ TES-5600MHN connecting with  $4 \times 6\Omega/60W$  line array column loudspeakers.



Figure 8.5 TES-ADP24VA power adapter

- TES-ADP5V power adapter

Used for charging TES-560x series digital infrared wireless microphone and TES-5604CS series, TES-5604CHG/01 charging station.



Figure 8.4 TES-ADP5V power adapter

- TES-ADP5V6A power adapter

Connect to TES-5604CHG/09 for charging TES-5604 series digital infrared wireless microphones.



Figure 8.5 TES-ADP5V6A power adapter

## 8.2 Dedicated Cable

- **CBLRJ45 Ethernet Extension Cable**

CBLRJ45 Ethernet Extension Cable is used to connect between the TES-5600RN/30 receiver or the TES-56xxM classroom audio system and the TES-56xxBX control box. It features with drain wire and 2 shielded RJ45 plug.

Available lengths: 2, 5, 10, 20, 30, 40 or 50 meters.



Figure 8.6 CBLRJ45 dedicated cable

- **CBL-SPK2 speaker cable**

CBL-SPK2 Speaker cable is used for the HCL-1090 line array column loudspeaker or HPA-2240/2360 loudspeaker.

- 18AWG×2C
- Length of per roll: 610 meter
- Weight of per roll: 13.4 kg
- Color: black with white stripe



Figure 8.7 CBL-SPK2

- **CLB-SPK speaker cable**

CBL-SPK speaker cable is used for the HCL-1200 line array column loudspeaker.

- Length of per roll: 305 meter
- Weight of per roll: 14.1 kg
- Color: pearl white



Figure 8.8 CBL-SPK

- **RG-59 Coaxial-cable**

CBL-SPK speaker cable is used for connection between the TES-5600R and the digital IR wireless system control box/combo unit.

- Equivalent impedance: 75 Ohm
- Diameter: Ø 5 mm
- Length of per roll: 300 meter



Figure 8.9 CBL-SPK

- **Cat.5e extension cable**

CBL-CAT5e Cat.5e extension cable is used for embedding system cables; FTP CABLE with drain wire; Cable conductor: 4x2x(7x0.2)+7x0.2.

- Length of per roll: 305 meter
- Color: black

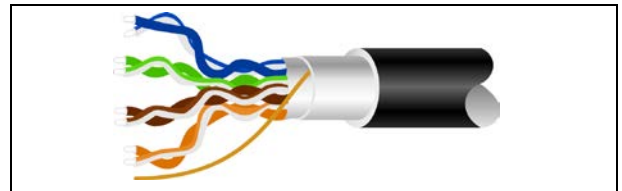

Figure 8.10 CBL-CAT5e Cat.5e extension cable

## 8.3 Charging Station

- **TES-5600CSL charging station**

- Charging one TES-5604 series IR microphone
- Built-in electronic lock in the charging station to safeguard the wireless microphone, scan the QR code with “TES-5600” APP or central control system via RS232 to unlock microphone.
- Powered by TES-ADP5V adapter
- Dimensions: 58 × 97 × 58 mm
- Color: white
- Weight: 0.3 kg





Figure 8.11 TES-5600CSL charging station

▪ **TES-5600CSN charging station**

- Charging one TES-5604 series IR microphone
- Built-in electronic lock in the charging station to safeguard the wireless microphone, can be unlocked via central control system (RS-232) or via network management system (TES-5604CSW Classroom Audio System Management Platform).
- Powered by TES-ADP5V adapter
- Dimensions: 58 × 97 × 58 mm
- Color: white
- Weight: 0.3 kg

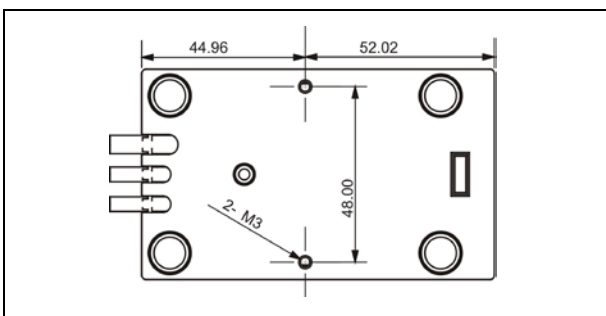

Figure 8.12 TES-5600CSN charging station

**Note:**

☞ Please scan the QR code on [www.taiden-edu.com](http://www.taiden-edu.com) to install the “TES-5600” APP.

5600CSN charging station can be fixed to the desktop through the positioning hole at the bottom. The installation cutout diagram is as below:



▪ **TES-5604CHG/01 charging station**

TES-5604CHG/01 can charge one TES-5604 series microphone with TES-ADP5V.



Figure 8.13 TES-5604CHG/01 charging station

▪ **TES-5604CHG/02 charging station**

TES-5604CHG/02 can charge two TES-5604 series microphones with TES-ADP5V.



Figure 8.14 TES-5604CHG/02 charging station

▪ **TES-5604CHG/09 charging station**

TES-5604CHG/09 can charge nine TES-5604 series microphones at the same time with TES-ADP5V6A.

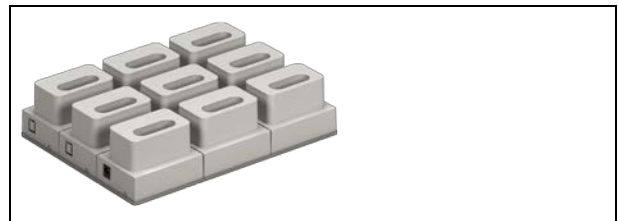

Figure 8.15 TES-5604CHG/09 charging station

## 8.4 Microphone

### ▪ TES-1021 clip microphone

Used for TES-5604/07 series microphones.

- Ø 3.5 mm stereo plug with a 0.3-meter cable
- Weight: 10 g



Figure 8.16 TES-1021

### ▪ TES-1022 single-ear microphone

Used for TES-5604/07 series microphones.

- Ø 3.5 mm stereo plug with a 0.55-meter cable
- Weight: 11 g



Figure 8.17 TES-1022

### ▪ TES-1023 head-worn microphone

Used for TES-5604/07 series microphones.

- Ø 3.5 mm stereo plug with a 1-meter cable
- Weight: 18 g



Figure 8.18 TES-1023

## 8.5 TES-5600ZJ2



Figure 8.19 TES-5600ZJ2

TES-5600ZJ2 stand is used to mount the TES-5600RN series receiver and TES-5630MA combo unit

- height can be adjusted from 1.1 m to 2.7 m,
- weight 3.9 kg.

## 8.6 TES-5600RZJ

TES-5600RZJ is suitable for tripod or wall mounted of TES-5600R(N).

- Length: 115 mm
- Weight: 110 g



Figure 8.20 TES-5600RZJ

## 8.7 MA-120P retractable hanging bar

Used for mounting TES-5675 series hanging microphone

- Length: 0.6 meter, can be adjusted up to 1.2 meter
- Weight: 320 g



Figure 8.21 MA-120P retractable hanging bar

## 8.8 TES-5685P Series Suspension

Used for TES-5685M series classroom audio system.

- Length: 0.5/1.0/1.5 m.



Figure 8.22 TES-5685P suspension

## 8.9 TES-5600M Series Cabinet Installation Accessories

- **TES-5600M Cabinet Installation Accessories (single unit)**

Used for installing one TES-5600M Series Digital Infrared Wireless System Main Unit to cabinet.

- Weight: 0.3 kg

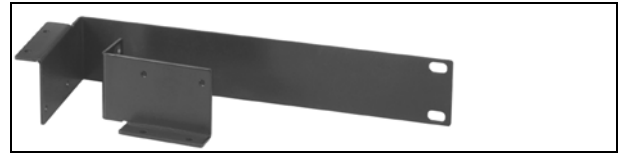

Figure 8.23 TES-5600M Cabinet Installation Accessories (single unit)

- **TES-5600M Cabinet Installation Accessories (two units)**

Used for installing two TES-5600M Series Digital Infrared Wireless System Main Unit to cabinet.

- Weight: 0.2 kg



Figure 8.24 TES-5600M Cabinet Installation Accessories (two units)

## 8.10 TES-5604NS Neck Lanyard

- **TES-5600NS\_W and TES-5600NS\_W/20**

Used for TES-560x series microphones, white hanging piece

- Weight: 197g

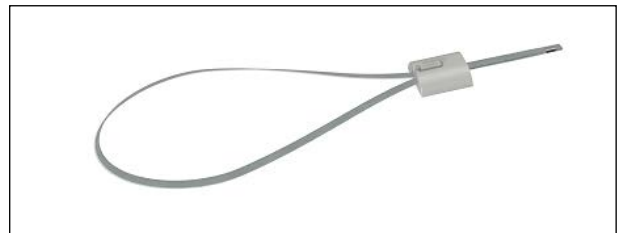

Figure 8.25 TES-5600NS\_W

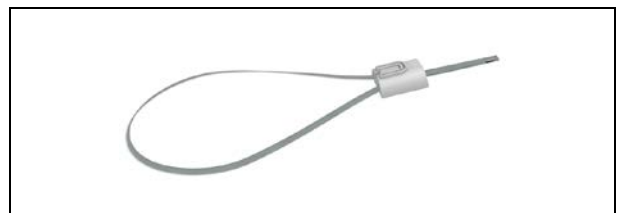

Figure 8.26 TES-5600NS\_W/20

▪ **TES-5600CLP**

Used for TES-560x series microphones,

- Direction adjustable
- Weight: 6 g.

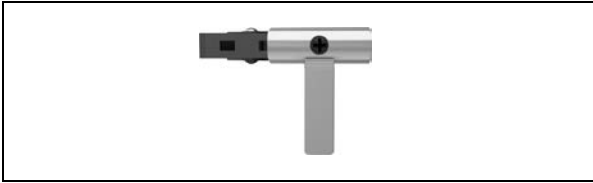

Figure 8.27 TES-5600CLP

## 8.11 Cable Splitter

▪ **TES-0104T/30**

Used for extending TES-5600RN/30 series receiver

- 1 input and 4 output RJ45 interfaces.
- Weight: 68 g



Figure 8.28 TES-0104T/30

▪ **1 × 2 BNC cable splitter**

Used for extending TES-5600R series receiver

- 1 input and 2 output BNC interfaces.
- Weight: 115 g



Figure 8.29 1 × 2 BNC cable splitter

▪ **SB-408C3 (third-party fitting)**

Used for extending TES-5600R

- One input and four output interfaces
- 5 F interfaces, used with RG-6/U cable
- Weight: 30 g



Figure 8.30 SB-408C3

**Note:**

☞ The length of every extent cable must be the same.

## 8.12 Stem Microphone

▪ **MS50/60/70EGD2B stem microphone**

Built-in windshield, dual-flex gooseneck arm, used for TES-5600 series wired microphone.

- Length: 50 cm, 60 cm, 70 cm
- Weight: MS50EGD2B: 102 g  
MS60EGD2B: 105 g  
MS70EGD2B: 107 g

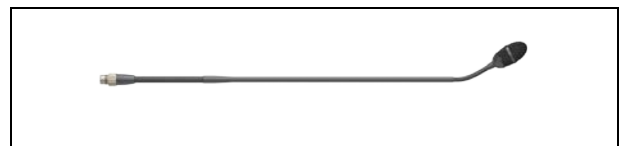

Figure 8.31 Stem microphone

## 8.13 Speaker

▪ **HSP-106E 6.5-inch Ceiling Loudspeaker**



Components: 1×6.5" woofer unit + 1×0.75" tweeter

Ceiling-mount

ABS panel + metal box

Coaxial structure

Frequency Range: 90 Hz – 20 kHz (-10 dB)

Sensitivity: 94 dB

Nominal Impedance: 8 Ω

Power consumption: 60 W

Coverage Pattern: 90°(H)×90°(V)

Max SPL: 108 dB SPL, 114 dB SPL peak

Input Interface: Phoneix 4pin

Dimensions: Ø250 × 216 mm

Weight: 2.7 kg

▪ **HPA-2240(A/B) wall-mounted speaker**



Wall-mounted, equipped with U bracket;  
 Dimensions: 290 × 215 × 190 mm;  
 Power consumption: 8 Ω, 40 W;  
                                 6 Ω, 40 W (HPA-2240B);  
 Line voltage: 70~100 V (HPA-2240A);  
 Frequency response: 65 Hz~20 kHz;  
 Sensitivity: 90 dB;  
 Weight: 3.4 kg

▪ **HCL-1090 line array column loudspeaker**



Components: 2.5 inch full-range × 3;  
 Wall-mounted or stand-mount;  
 Enclosure: Fiberglass reinforced ABS cabinet, painted aluminum grille;  
 Outdoor capability: IP-54 rated, per IEC529, moisture- and water-proof, dust-proof, water-proof cable gland;  
 Coverage pattern: Horizontal: 150°, vertical: 30°;  
 Max. SPL: 105 dB  
 Power consumption: 60 W (240 W peak), 2 hrs  
                                 36 W (144 W peak), 100 hrs;  
 Impedance: 6 Ω;  
 Frequency response: 80 Hz~18 kHz;  
 Sensitivity: 90 dB;  
 Dimensions: 400 × 102 × 160 mm;  
 Weight: 2.2 kg

▪ **HCL-1090B line array column loudspeaker**



Components: 3.0 inch full-range × 4;  
 Wall-mount or stand-mount;  
 Enclosure: Fiberglass reinforced ABS cabinet, painted aluminum grille;  
 Outdoor capability: IP-55 rated, per IEC529, moisture- and water-proof, dust-proof, water-proof cable gland;  
 Coverage pattern: Horizontal: 150°, vertical: 30°;  
 Max. SPL: 107 dB  
 Power consumption: 60 W (240 W peak), 2 hrs  
                                 36 W (144 W peak), 100 hrs;  
 Impedance: 6 Ω;  
 Frequency response: 80 Hz~20 kHz;  
 Sensitivity: 90 dB;  
 Dimensions: 408 × 111 × 145 mm;  
 Weight: 2.4 kg

▪ **HCL-1200 line array column loudspeaker**



Components: 2.5 inch full-range × 8;  
 Swivel (pan) / tilt wall-mounted or stand-mount;  
 Enclosure: Fiberglass reinforced ABS cabinet, painted aluminum grille;  
 Outdoor capability: IP-54 rated, per IEC529, moisture- and water-proof, dust-proof, water-proof cable gland;

Coverage pattern: Horizontal: 150°, vertical: 30°;  
 Max. SPL: 120 dB (speech mode)  
 117 dB (music mode);  
 Power consumption: 200 W (800 W peak), 2 hrs  
 120 W (480 W peak), 100 hrs;  
 Impedance: 6 Ω;  
 Frequency response: 80 Hz~18 kHz (-10 dB);  
 Sensitivity: 93 dB (speech mode)  
 89 dB (music mode);  
 Dimensions: 620×102×155 mm;  
 Weight: 5.3 kg

▪ **HSP-108E 8-inch Two-way Loudspeaker**



Components: 1×8" composite carbon fiber diaphragm  
 woofer unit + 1×2" nano carbon fiber diaphragm tweeter  
 Enclosure Material: Birch + black polyurea finish  
 Power: Noise Power: 200 W (AES)  
 PGM Power: 400 W/ Peak Power: 800 W  
 Nominal Impedance: 8 Ω  
 Frequency Range: 70 Hz-20 kHz (±3 dB)  
 50 Hz-25 kHz (-10 dB)  
 Sensitivity: 96 dB  
 Max SPL 119 dB SPL, 125 dB SPLpeak  
 Coverage Pattern: 50°-100° (H) gradient × 60° (V)  
 asymmetric, rotatable horn  
 Input Interface: 2 × Speakon  
 Dimensions (H × W × D): 460 × 265 × 250mm  
 Weight: 11 kg  
 Optional Accessories: HSP-108BKTU U-shaped wall  
 bracket

▪ **HCL-404E 4 Units Two-way Column Loudspeaker**



Components: 4×4" complex carbon fiber diaphragm  
 midwoofer units + 12×0.75" nano carbon  
 fiber diaphragm tweeters  
 Enclosure Material: Birch + black polyurea finish  
 Power Noise Power: 200W(AES)  
 PGM Power: 400W/ Peak Power: 800W  
 Nominal Impedance: 8 Ω  
 Frequency Range: 80 Hz - 20 kHz (±3 dB)  
 60 Hz-25 kHz (-10 dB)  
 Sensitivity: 100 dB  
 Max SPL: 123dB SPL, 129 dB SPLpeak  
 Coverage Pattern: 100°(H)×15°(V)  
 Input Interface: 2 x Phoneix 2pin  
 Dimensions (H × W × D): 450×130×180 (mm)  
 Weight: 5.2 kg  
 Accessories: 2 x wall screw

▪ **HCL-404EJ 4 Units Two-way Column Loudspeaker**



Components: 4×4" complex carbon fiber diaphragm  
 midwoofer units + 12×0.75" nano carbon  
 fiber diaphragm tweeters  
 Enclosure Material: Birch + black polyurea finish  
 Power: Noise Power 200W(AES)  
 PGM Power:400W  
 Peak Power 800W  
 Sensitivity: 98 dB  
 Nominal Impedance: 8 Ω  
 Frequency Range: 80 Hz-20 kHz (±3 dB)/ 60 Hz-25 kHz  
 (-10 dB)  
 Coverage Pattern: 100° (H)×40° (V) (+15° --25° )  
 Max SPL: 121dB SPL, 127 dB SPLpeak  
 Input Interface: Phoneix 2pin  
 Dimensions (H × W × D): 450×130×180/97 (mm)  
 Weight: 4.9kg  
 Accessories: 2 x wall screw  
 Optional Accessories: HCL-404BKT Swivel (pan)/tilt wall  
 bracket

# Chapter 9 Technical data

## 9.1 System specification

### System performance

Conforms to IEC 60914, the international standard for conference systems

### Transmission characteristics

**IR transmission wavelength:** 870 nm

**Modulation frequency:** 1 to 8 MHz

**Protocol and modulation:** DQPSK

### System environmental conditions

**Working conditions fixed/stationary/portable**

**Temperature range:**

- Transport: -40 °C to +70 °C

- Operating: 0 °C to +45 °C

**Max. Relative humidity:** < 95% (not condensing)

**Safety:** Compliant with EN 60065

**EMC emission:** Compliant with EN 55022

**EMC immunity:** Compliant with EN 55024

**EMC approvals:** CE, FCC

**Power harmonics:** Compliant with EN 61000-3-2

**Voltage fluctuations and flicker:** Compliant with EN 61000-3-3

## 9.2 TES-5680 classroom audio system

Type		TES-5680M/30	TES-5680BX/30
Power		Power supply by TES-5680BX/30	DC 24 V 2.7 A (TES-ADP24V adapter)
Cable		CBLRJ45 Ethernet Extension Cable	
Line in		Nominal value: +2 dBu; maximum value: +11 dBu	
Line in impedance		22 k $\Omega$	
Line out		Nominal value: +2 dBu; maximum value: +11 dBu	
Line out impedance		100 $\Omega$	
Maximal number of microphone		2	
Speaker interface (Max.)			2 $\times$ 60 W (8 $\Omega$ ) 4 $\times$ 30 W (8 $\Omega$ )
External control terminal		RS-485, 3-pin Phoenix	
Weighted signal-to-noise ratio		Mic. to main unit: $\geq$ 90 dB(A)	
Audio frequency response		Main unit to main unit :50-20000 Hz Mic. to main unit: 100-20000 Hz	
Total harmonic distortion at 1 kHz		Mic. to main unit: $\leq$ 0.05 %	
Dynamic range		Mic. to main unit: $\geq$ 85 dB	
Array microphone	Weighted signal-to-noise ratio	$\geq$ 65.5 dB(A)	
	Audio frequency response	100 Hz – 10 kHz	
	Total harmonic distortion	$\leq$ 0.1% (at 1 kHz)	
	Directivity	$\pm$ 15° (Beam forming)	
Pickup range		5 m radius with medium ambient noise 8 m radius in a quiet environment	
Dimensions (mm)			
Weight		0.4 kg	0.4 kg
Color		Silver	Black

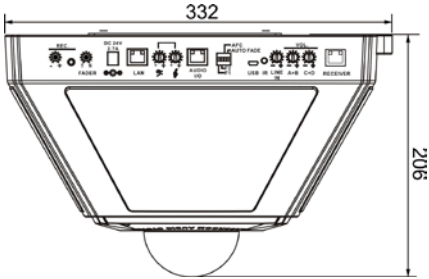
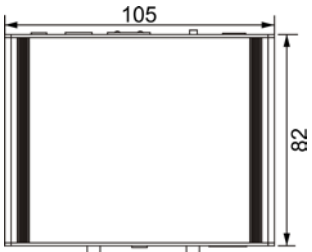
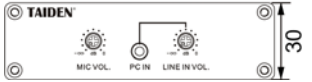

### 9.3 TES-5685 series classroom audio system

Type		TES-5685MA/30	TES-5685MB/30	TES-5685MC/30	TES-5685BX/30
Power		100-240V 50/60 Hz			Power supply by TES-5685M
Cable		CBLRJ45 Ethernet Extension Cable			
Line in		Nominal value: +2 dBu; maximum value: +10 dBu			
Line in impedance		22 k $\Omega$			
Line out		Nominal value: +11 dBu; maximum value: +17 dBu			
Line out impedance		100 $\Omega$			
Maximal number of microphone		2	2	1	--
Speaker interface (Max.)		4 × 30 W (12 $\Omega$ )			--
Weighted signal-to-noise ratio		Mic. to main unit: $\geq$ 90 dB(A)			
Audio frequency response		Main unit to main unit :50-20000 Hz Mic. to main unit: 100-20000 Hz			
Total harmonic distortion		Mic. to main unit: $\leq$ 0.05 % (at 1 kHz)			
Dynamic range		Mic. to main unit: $\geq$ 85 dB			
Array microphone	Weighted signal-to-noise ratio	$>$ 65.5 dB(A)		--	
	Audio frequency response	100 Hz – 10 kHz			
	Total harmonic distortion	$<$ 0.1% (at 1 kHz)			
	Directivity	$\pm$ 15° (Beam forming)			
Dimensions (mm)					 
Weight		3.5 kg			0.2 kg
Color		White			Black

## 9.4 TES-5600 series digital infrared wireless classroom audio system

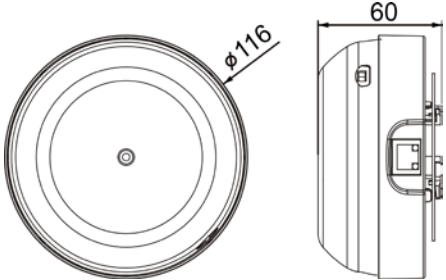
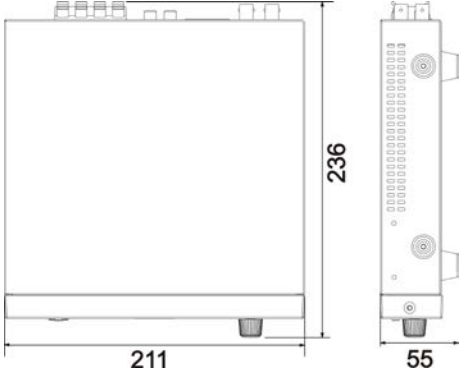
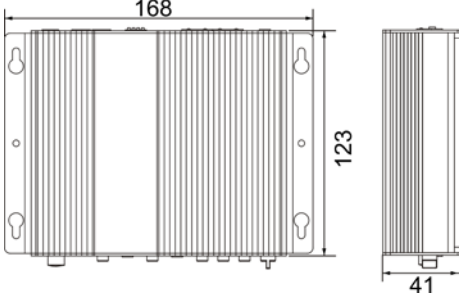
Type	TES-5600RN series	TES-5600MAU/30	TES-5600BX/30
Power	Supplied from TES-5600BX series /TES-5600MAU series	24V DC, 2.7 A (TES-ADP24V)	
Cable	CBLRJ45 Ethernet Extension Cable		
Line in	--	Nominal value: +2 dBu; maximum value: +12 dBu	Nominal value: +6 dBu; maximum value: +12 dBu
Line out	--	Nominal value: +8 dBu; maximum value: +18 dBu	Nominal value: -20 dBu; maximum value: +18 dBu
Line out impedance	--	100 $\Omega$	500 $\Omega$
Weighted signal-to-noise ratio	$\geq$ 90 dBA		$\geq$ 90 dBA
Dynamic range	$\geq$ 85 dB		$\geq$ 100 dB
Audio frequency response	Main unit to main unit: 50-20000 Hz Mic. to main unit: 100-20000 Hz		
Total harmonic distortion	$\leq$ 0.05% (at 1 kHz)		
Maximal microphone	1 ( TES-5600RN1/30 ) 2 ( TES-5600RN/30 )	1 ( TES-5600BX1/30 ) 2 ( TES-5600MAU, TES-5600MAR TES-5600BX2/30 )	
Maximum output power of PA	--	2x60 W ( 8 $\Omega$ / 6 $\Omega$ ) 4x30 W ( 8 $\Omega$ )	
Dimensions (mm)	 <p style="text-align: center;">TES-5600RN</p>		 <p style="text-align: center;">TES-5600MAU Series</p>  <p style="text-align: center;">TES-5600BX/30</p>
Weight	0.2 kg	0.4 kg	
Color	Dark red	Black	

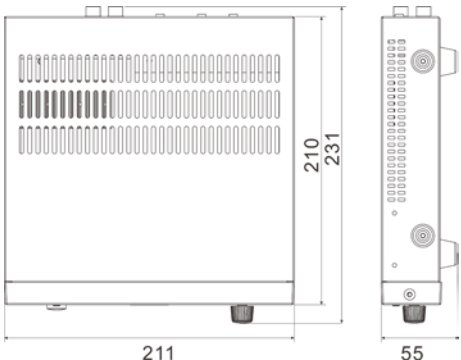
Type	TES-5600MRN / TES-5600MHN
Power	24V DC, 2.7 A (TES-ADP24V)
Cable	CBLRJ45 Ethernet Extension Cable (for connection to TES-5600RN/30 series)
Line in	Nominal value: +2 dBu; maximum value: +12 dBu
Line out	Nominal value: +4 dBu; maximum value: +14 dBu;
Line out impedance	100 $\Omega$
Maximal microphone	2
Maximum output power of PA	2x60 W ( 8 $\Omega$ ); 4x30 W ( 8 $\Omega$ )
Weighted signal-to-noise ratio	$\geq$ 90 dBA
Dynamic range	$\geq$ 100 dB
Audio frequency response	Main unit to main unit: 50-20000 Hz Mic. to main unit: 100-20000 Hz
Total harmonic distortion	$\leq$ 0.05%
Dimensions (mm)	 <p>Technical drawing showing the dimensions of the device in millimeters. The front view shows a width of 211 mm and a height of 231 mm. The side view shows a depth of 55 mm.</p>
Weight	1.2 kg
Color	Black

## 9.5 TES-5690 classroom audio system

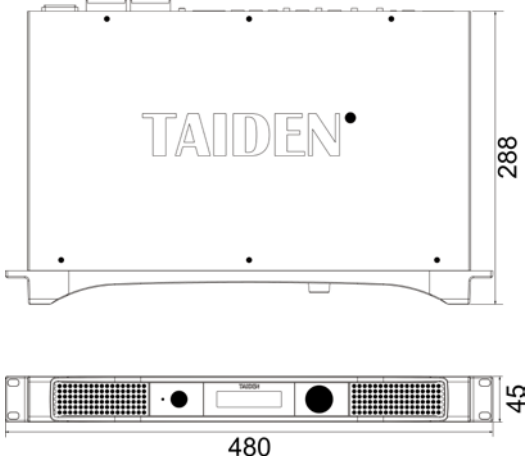
Type	TES-5690MA	TES-5690MB	TES-5690MC
Power	AC 100-240 V, 3.0-1.5A		AC 100-240 V, 2.3-1.2A
Line in	Nominal value: +6 dBu; maximum value: +12 dBu		
Line in impedance	Single-ended input :10 kΩ; differential input :20 kΩ		
Line out	Nominal value: -20 dBu; maximum value: +18 dBu		
Line out impedance	50 Ω		
Maximal number of microphone	2		
Speaker interface (Max.)	2 × 200 W +2 × 60 W (6 Ω)	2 × 200 W (6 Ω)	4 × 60 W (6 Ω)
Weighted signal-to-noise ratio	Mic. to main unit: ≥ 90 dB(A)		
Audio frequency response	Main unit to main unit :50-20000 Hz Mic. to main unit: 100-20000 Hz		
Total harmonic distortion at 1 kHz	Mic. to main unit: ≤ 0.05 %		
Dynamic range	Mic. to main unit: ≥ 85 dB		
Dimensions (mm)			
Weight	4.3 kg	4.0 kg	
Color	Black		

## 9.6 Digital infrared wireless microphone

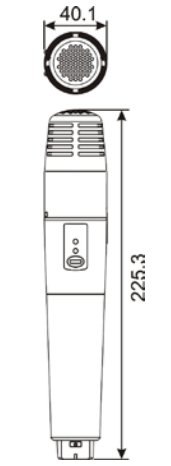
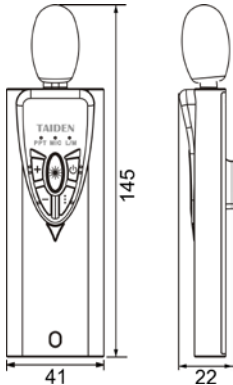
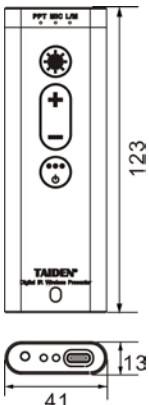
Type	TES-5602A_G	TES-5604N_W	TES-5608
Remote volume control			√
Power	USB supply (5 V 2A)		
Current consumption	≤ 290 mA		≤ 320 mA
Infrared emitter	Wavelength		
	870 nm (AM: Brightness modulation)		
	Modulation method		
	DQPSK		
	Carrier frequency		
Audio channel 1/2/3/4/5: 1.00 /1.67/ 2.33/ 3.00/ 3.67 MHz			
Emission angle			
Vertical: 0°~ 90°, Horizontal: 120°			
Emission range			
Optical range: 25 m			
Operation time of battery	6 hours	7 hours	7 hours
Capacity of battery	1600 mAh	2300 mAh	2300 mAh
Charging time	2.5 hours	3 hours	3.5 hours
Mic. input impedance	600 Ω		
Dimensions (mm)	 <p>TES-5602A_G</p>	 <p>TES-5604N</p>	
Weight	146 g	60 g	20 g (TES-5608AN) 90 g (TES-5608BN/CN)
Color	Grey	White	Dark red (TES-5608AN) Space Grey (TES-5608BN/CN)

## 9.7 Hanging microphone

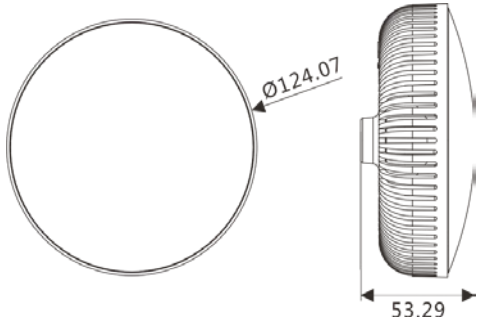
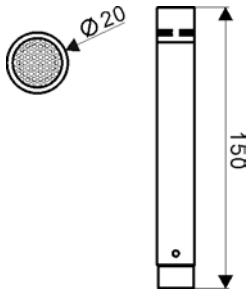
Type		TES-5675S	TES-5675T	TES-5675H
Power		Phantom power 11 ~ 52 V, 2mA		
Dimensions (mm)				
Weight		140 g	140 g	140 g
Color		灰色	灰色	黑色
Microphone	Microphone type	Omnidirectional microphone	14mm Cardioid unidirectional microphone	
	Sensitivity	-32 dBV/Pa	-30 dBV/Pa	-32 dBV/Pa-
	Frequency response	50 Hz - 20 kHz		
	Output impedance	230 Ω	230 Ω	280 Ω
	Directivity 0°/180°	> 20 dB (1 kHz)	> 20 dB (1 kHz)	
	Equivalent noise	20 dBA (SPL)		
	Maximum sound pressure	125 dB (THD<3%)	125 dB (THD<3%)	139 dB (THD<3%)
	Pickup distance	5 m	5 m	5 m

## 9.8 Power adapter

Type	TES-ADP24V	TES-ADP24VA	TES-ADP5V6A	TES-ADP5V	TES-ADP19V
Mains voltage	AC 100-240 V, 50 /60 Hz				
Output	24 V DC, 2.7 A	24 V DC, 3.75 A	5 V DC, 6.0 A	5 V DC, 2.0 A	19 V DC, 3.42 A
Cable Length	3 m	3 m	2.8 m	1.0 m	1.5 m
Dimensions (mm) w x h x d	115 x 50 x 32		121 x 52 x 33	39 x 27 x 43	121 x 52 x 33
Weight	0.4 kg		0.4 kg	50 g	0.3 kg
Color	Black	Black	Black	White	Black

## 9.9 Charging unit / microphone

Type	TES-5600MIC	TES-5600CSM	TES-5600CSML	TES-5600CSMN
Voltage	5 V DC, 2.0 A (TES-ADP5V)			
Dimensions (mm)				
Weight	0.5 kg	0.6 kg		
Color	Black			
Microphone	Type	Uni-directional electret condenser microphone		
	Sensitivity	-46 dBV/Pa		
	Frequency response	75-20000 Hz		
	Directivity 0°/180°	≥20 dB (1kHz)		
	Equivalent noise	20 dBA (SPL)		
	Maximum sound pressure level	115 dB (THD<3%)		
	Stem microphone	MS60EGD2B (standard) MS50EGD2B / MS70EGD2B (optional)		

Type	TES-5600CSL	TES-5600CSN
Voltage	5 V DC, 2.0 A (TES-ADP5V)	
Dimensions (mm)		
Weight	0.3 kg	
Color	White	

Type	TES-5604CHG/09	TES-5604CHG/01	TES-5604CHG/02
Voltage	5 V DC, 6.0 A (TES-ADP5V6A)	5 V DC, 2.0 A (TES-ADP5V)	
Dimensions (mm)			
Weight	0.8 kg	0.1 kg	0.2 kg
Color	White		

## 9.10 Connection details

### 6.4 mm Jack plug

- Tip① Balance/ Unbalance signal +
- Ring② Balance/ Unbalance signal -
- Sleeve③ Ground/ Shield

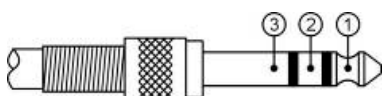

### 3.5 mm Jack plug

- Tip① Left signal
- Ring② Right signal
- Sleeve③ Ground/ Shield

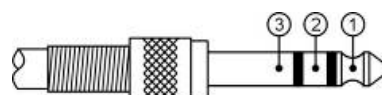



# Appendix

## How to Select and Wire Ethernet Cable for TAIDEN New Generation System

CAT5e Ethernet cable with a drain wire connected to shielded RJ45 crimp connectors is required for setting up TAIDEN New Generation System. Audio and control signal, and other data are all transmitted over CAT5e cables. No attenuation in signal quality and amplitude, can avoid ground noise and possible interferences from other devices, providing improved system reliability. Users can also lay cables beforehand, enjoying greater convenience and flexibility.

### 1. CAT5e Ethernet cable is applicable for:

TES-5600RN/30 series digital infrared receiver

### 2. Materials needed for wiring CAT5e Ethernet cable:

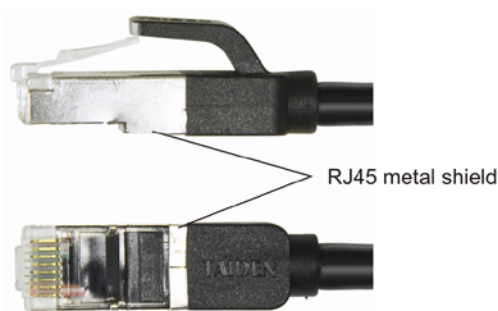

Shielded RJ45 crimp connector

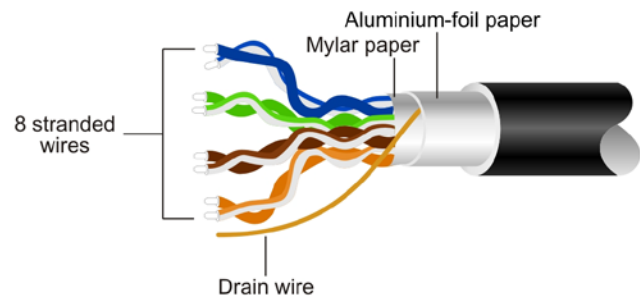

CAT5e cables as shown above, with a drain wire between aluminium-foil paper and mylar paper

### 3. How to wire CAT5e Ethernet cable:

Arrange the colored wires according to T568A and T568B standards.

RJ45 pinout wiring order: Clip is pointed away from you. The order from left to right is shown below:

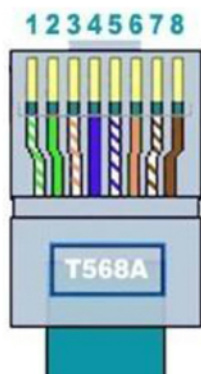

Wiring order (1-8) according to T568A standard:  
white-green, green, white-orange, blue,  
white-blue, orange, white-brown, brown



Wiring order (1-8) according to T568B standard:  
white-orange, orange, white-green, blue,  
white-blue, green, white-brown, brown

Ethernet Cable used for TAIDEN New Generation System should be straight through, with both ends using the same wiring standard (T568B is commonly used).

Please connect the drain wire to the metal shield of the RJ45 connector.

**TAIDEN INDUSTRIAL CO., LTD.**

6/F, Block B, Future Plaza, 4060 Qiaoxiang Rd, Nanshan District, Shenzhen, China

P.C.: 518053

Website: <http://www.aiden.com>

Copyright by TAIDEN

**Last Revision: 09/2022**

# Digital Infrared Classroom Audio Reinforcement System



**Digital Infrared Classroom Audio Reinforcement System**

<b>Digital Infrared Classroom Audio Reinforcement System</b> .....	<b>3</b>
<b>TES-560X Series Digital Infrared Wireless Microphone</b> .....	<b>4</b>
TES-5602A_G Digital Infrared Wireless Microphone (handheld type, charcoal gray, with rechargeable battery, excl. adapter).....	4
TES-5604N_W Digital Infrared Wireless Microphone (white, built-in rechargeable lithium battery, with laser pointer, excl. adapter, used with TES-5600NS_W neck lanyard or TES-5600CLP clip).....	5
TES-5608AN Digital Infrared Clip Microphone.....	6
TES-5608BN/20 Digital Infrared Wireless Presenter (space gray, with digital laser pointer, built-in rechargeable lithium battery, with neck lanyard and belt case, excl. adapter).....	6
TES-5608CN/20 Digital Infrared Wireless Presenter (space gray, with digital laser pointer, built-in rechargeable lithium battery, with neck lanyard and belt case, excl. adapter).....	6
<b>TES-5600 Series Wired Desktop Microphone</b> .....	<b>7</b>
TES-5600MIC Wired Desktop Microphone (standard stem microphone: 60cm, optional: 50/70cm).....	7
TES-5600CSMN Wired Desktop Microphone (standard stem microphone: 60cm, optional: 50/70cm; with a lockable charging station for one TES-5604 series microphone, can be unlocked via central control system or via network management system; support network management when used with TES-5604NSW Wireless Microphones Management Platform; with TES- ADP5V power adapter).....	7
TES-5600CSML Wired Desktop Microphone (standard stem microphone: 60cm, optional: 50/70cm; with a lockable charging station for one TES-5604 series microphone, can be unlocked by scanning QR code or via central control system; with TES- ADP5V power adapter).....	8
TES-5600CSM Wired Desktop Microphone (standard stem microphone: 60cm, optional: 50/70cm; with a charging station for two TES-5604 series microphones, with TES- ADP5V power adapter).....	8
MS50EGD2B Stem Microphone (50cm, built-in windshield, flexible gooseneck tube, for TES-5600 series Wired Desktop Microphone, black).....	9
MS60EGD2B Stem Microphone (60cm, built-in windshield, flexible gooseneck tube, for TES-5600 series Wired Desktop Microphone, black).....	9
MS70EGD2B Stem Microphone (70cm, built-in windshield, flexible gooseneck tube, for TES-5600 series Wired Desktop Microphone, black).....	9
<b>TES-5675 Series Hanging Microphone</b> .....	<b>10</b>
TES-5675T Hanging Microphone (Gray, round, 14mm Cardioid unidirectional microphone, pick up the audio of the teachers' lecture).....	10
TES-5675S Hanging Microphone (Gray, round, omnidirectional microphone, pick up students' interactive audio).....	10
TES-5675H Hanging Microphone (Black, 14mm Cardioid unidirectional microphone, pick up the audio of the teachers' lecture).....	11
<b>TES-5600RN Series Digital Infrared Receiver</b> .....	<b>12</b>
TES-5600RN/30 Digital Infrared Receiver (RJ45 interface, ceiling, wall or tripod-mounted, support 2 wireless microphones).....	12
TES-5600RN1/30 Digital Infrared Receiver (RJ45 interface, ceiling, wall or tripod-mounted, support 1 wireless microphones).....	13
<b>TES-5600 Series Digital Infrared Classroom Audio System Main Unit</b> .....	<b>14</b>
TES-5600BX1/30 Digital Infrared Classroom Audio System Control Box (with RJ45 interface, supports 1 wireless microphones, built-in audio power amplifier can be connected to 4 loudspeakers, can connect to TES-5600 series Wired Desktop Microphone for audio transmission, 2 line in, 1 line out, with TES-ADP24V adapter).....	14
TES-5600BX2/30 Digital Infrared Classroom Audio System Control Box (with RJ45 interface, supports 2 wireless microphones, built-in audio power amplifier can be connected to 4 loudspeakers, can connect to TES-5600 series Wired Desktop Microphone for audio transmission, 2 line in, 1 line out, with TES-ADP24V adapter).....	15

TES-5600MAU/30	Digital Infrared Classroom Audio System Main Unit (supports 2 wireless microphones, built-in amplifier, supports 4 speakers, can connect to TES-5600 series Wired Desktop Microphone for audio transmission, USB interface for digital audio input/output, phantom power, RJ45 interface to extend receiver, with adapter).....	17
<b>TES-5630M Series Economical Digital Infrared Classroom Audio System.....</b>		<b>19</b>
TES-5630MA	Economical Digital Infrared Classroom Audio System (with digital infrared receiver, supports 1 wireless microphone, built-in amplifier, supports 2 loudspeakers, with adapter).....	19
<b>TES-568xM Series Digital Infrared Classroom Speaker.....</b>		<b>21</b>
TES-5685MB-F/30	Digital Infrared Classroom Speaker (with digital infrared receiver, supports 2 wireless microphones, analog audio input/output, built-in audio power amplifier and integrated loudspeakers, RJ45 interface for extending receiver, Type F plug).....	21
TES-5685MB-B/30	Digital Infrared Classroom Speaker (with digital infrared receiver, supports 2 wireless microphones, analog audio input/output, built-in audio power amplifier and integrated loudspeakers, RJ45 interface for extending receiver, Type B plug).....	22
TES-5685MC-F/30	Digital Infrared Classroom Speaker (with digital infrared receiver, supports 1 wireless microphone, analog audio input/output, built-in audio power amplifier and integrated loudspeakers, RJ45 interface for extending receiver, Type F plug).....	23
TES-5685MC-B/30	Digital Infrared Classroom Speaker (with digital infrared receiver, supports 1 wireless microphone, analog audio input/output, built-in audio power amplifier and integrated loudspeakers, RJ45 interface for extending receiver, Type B plug).....	24
TES-5685BX/30	Function Extension Box (for TES-5685M series, analog audio input/output, can connect to TES-5600 series Wired Desktop Microphone for audio transmission, 1 line out+1 line in).....	25
TES-5685BXP/30	Function Extension Box (for TES-5685M series, analog audio input/output, can connect to TES-5600 series Wired Desktop Microphone for audio transmission, 1 line out+1 line in, 1 PA in + 1 PA trigger).....	25
<b>TES-5690 Series Classroom Audio System Main Unit.....</b>		<b>27</b>
TES-5690MA	Digital Infrared Classroom Audio System Main Unit (supports 2 wireless microphones, with DSP, built-in audio power amplifier 2x200 W+2x60 W, network control).....	27
TES-5690MB	Digital Infrared Classroom Audio System Main Unit (supports 2 wireless microphones, with DSP, built-in audio power amplifier 2x200 W, network control).....	28
TES-5690MC	Digital Infrared Classroom Audio System Main Unit (supports 2 wireless microphones, with DSP, built-in audio power amplifier 4x60 W, network control).....	29
<b>TES-5600MRN Series Classroom Audio System Main Unit.....</b>		<b>31</b>
TES-5600MRN	Digital Infrared Classroom Audio System Main Unit (with RJ45 interface, built-in webserver, can be setup and managed by Smart Classroom Management Platform, supports 2 wireless microphones and 2 TES-5675 Hanging microphones, built-in audio power amplifier can be connected to 4 loudspeakers, can connect to TES-5600 series Wired Desktop Microphone for audio transmission, USB interface for digital audio input/output, remote interactive features, with TES-ADP24V adapter).....	31
TES-5600MHN	Digital Infrared Classroom Audio System Main Unit (with RJ45 interface, built-in webserver, can be setup and managed by Smart Classroom Management Platform, supports 2 wireless microphones and 2 TES-5675 Hanging microphones, built-in audio power amplifier can be connected to 4 loudspeakers, can connect to TES-5600 series Wired Desktop Microphone for audio transmission, USB interface for digital audio input/output, with TES-ADP24V adapter).....	32
<b>TES-5600 series application software.....</b>		<b>34</b>
TES-5600SW	Digital Infrared Classroom Audio System Management Platform.....	35

## Digital Infrared Classroom Audio Reinforcement System

### System overview

TAIDEN, one of the world's renowned suppliers of digital conference systems and simultaneous interpretation system, has equipped prestigious international institutions and high profile events including the UN headquarters in New York, Council of Europe, G20 Summits, APEC Summits, Asia-Europe Meeting, and IMF-World Bank Annual Meetings.

In 2015, TAIDEN introduced its worldwide pioneering digital infrared technology into the field of multimedia teaching and released a series of classroom audio systems which can be categorized as Digital IR Wireless Classroom Audio Reinforcement System, Interactive Recording and Webcasting Audio System and Lecture Recording Management Platform. The audio systems featuring excellent audio clarity, great immunity to interference and convenient management fully satisfy the need for sound reinforcement, interactive recording and webcasting, and centralized management of all the multimedia equipment in classrooms. In addition, the wireless microphone of digital IR technology provides safe and RF radiation free use. What's more, the e-lock charging station for wireless microphones frees school AV/IT teams from keeping and charging the microphones.

### System theory

The core of the TAIDEN digital infrared wireless classroom audio system – dirATC (digital infrared Audio Transmitting and Control technologies) - is a new technology originated by TAIDEN. It encodes and modulates audio and data signals digitally for transmission via infrared light, achieving both multi-channel audio signals and bidirectional data transmission and control. Digitalization and wireless transmission via infrared technology are integrated to make an ideal solution for a wireless conference system. TAIDEN's infrared audio transmission and control technology (dirATC) is built on its processing chip by integrating A/D (analog/digital) conversion circuit, digital encoding/decoding circuit, digital modulator/demodulator (DQPSK), and filtering and amplification circuit.



TAIDEN TDIR04 digital infrared processing chip

### System features

#### Excellent Audio Clarity

- Crystal-clear audio everywhere within an operating range of 20 meters
  - ◆ Freq. response: main unit to main unit: 50 Hz to 20 kHz  
Mic. to main unit: 100 Hz to 20 kHz
  - ◆ SNR: Mic. to main unit: ≥90 dBA
  - ◆ THD: Mic. to main unit: ≤0.05%
- Better audio acoustics protects lecturers from hoarse voice
- Clearer audio facilitates learning efficiency by helping students stay focus

#### Immunity to Interferences

- No crosstalk and interference between classrooms even when their systems are used at the same time
- Free from radio interference and electromagnetic radiation
- Insusceptible to interferences from HF-driven lighting and works perfectly in sunlight

#### Convenient Operation and Management

- Digital infrared microphones can be used in different classrooms without channel matching. Simply switch on and talk
- Integrated charging dock to park the microphone when it is not in use
- Electronic lock built in the dock to secure the microphone. Authorized users can scan QR code or swipe IC card to talk

#### No Electromagnetic Radiation

- Zero radio transmission
- Unaffected by radio frequency licensing

# TES-5602A

## Digital Infrared Wireless Microphone (handheld type)



### Functions

- World pioneering digital infrared wireless lecturing system
- Based on TAIDEN originated dirATC-digital infrared Audio Transmitting and Control technologies
- Excellent immunity to RF interferences from HF-driven lighting and it works in sunlight
- Digital infrared audio processing and transmitting technologies enable excellent audio quality
- Superior extension capability supports external audio input (Ø 3.5 mm AUDIO IN) and flexible transfer of signal with other audio devices (Mp3, mobile phone, etc.)
- Microphone channel and sensitivity adjustable
- Mute facility prevents constrained voice being transmitted
- Simple and comfortable handling
- Emission angle: vertical: 0°~ 90°, horizontal: 360°
- With rechargeable Li-ion battery, operation duration when microphone is continuously on about 6 hours
- LED battery capability indicator, could be charged via USB port or change battery
- Gravity Sensing
  - ◆ Detect the spatial location of the handheld microphone, enabling intellectual control of infrared emission angle, this ensures efficient coverage of infrared signal and can prolong the battery runtime
  - ◆ when the handheld microphone is detected being placed horizontally (no Audio In input) for a preset period of time, it will shut down automatically

### Controls and Indicators

- Charging indicator
- Power On/Off switch with indicator
- Mute button with indicator

### Interconnections

- Ø 3.5 mm jack for auxiliary audio input
- Two charging contacts
- USB port for charging

### Technical Specifications

#### Electrical

Power adapter.....DC 5 V, 2 A  
 (compatible with mobile phone charger)  
 Frequency response.....50 Hz to 20 kHz  
 SNR.....> 85 dBA  
 THD.....< 0.06%

#### Interface data

Connector.....Ø 3.5 mm jack for auxiliary audio input

#### Operation time of battery

When mic. is continuously on.....Approx. 6 hours

#### Microphone

Type.....Uni-directional electret condenser microphone  
 Sensitivity.....-46 dBV/Pa  
 Frequency response.....75 Hz ~ 20 kHz  
 Input resistance.....680 Ω  
 Directivity 0°/180°.....> 20 dB (1 kHz)  
 Equivalent noise.....20 dBA (SPL)  
 Maximum sound pressure level.....115 dB (THD < 3%)

#### Mechanical

Dimensions.....225 x Ø 40 mm  
 Weight  
 Excl. battery.....146 g  
 Incl. battery.....182 g  
 Color.....Charcoal gray (PANTONE Cool Gray 11C)

### Ordering Information

TES-5602A\_G.....Digital Infrared Wireless Microphone  
 (handheld type, charcoal gray, with rechargeable battery, excl. adapter)

# TES-5604N\_W Digital Infrared Wireless Microphone



## Functions

- Original dirATC—digital infrared audio transmission and control technology
- Infrared transmitting carrier frequency conforms to IEC 61603-7, DQPSK digital modulation/demodulation technology
- Insusceptible to interferences from HF-driven lighting and works perfectly in sunlight
- Superior scalability, supporting audio input (Ø 3.5 mm AUDIO IN) from devices such as MP3 and mobile phone
- Supports audio input from external microphones
- Volume adjustment of the (fixed/external) microphone
- Remote control of PPT slides
- Supports laser pointer
- Supports PTT (push to talk)
- Transmitter powers off automatically when no voice is detected for a preset period of time
- Microphone channel adjustable
- Ergonomically compact and elegant design, can be held in hand or hung around the neck via a nice strap or fit on the necktie
- Emission angle: vertical: 0°~ 90°, horizontal: 120°
- Emission range: linear transmitting distance: over 25 m
- Built-in rechargeable lithium battery, operation duration when microphone is continuously on about 7 hours
- Charge via USB port (compatible with mobile phone charger) or via charging station

## Controls and Indicators

- Microphone on/off button
- Microphone volume up/down button
- Microphone on (MIC) indicator
- PPT mode indicator
- Charging indicator
- “...” button: select MIC/PPT mode
- Laser pointer button and transmitter

## Interconnections

- Ø 3.5 mm jack for auxiliary audio input
- Two charging contacts
- USB port for charging

## Technical Specifications

### Electrical

IR transmission wavelength.....	870 nm
Modulation method.....	DQPSK
Power.....	DC 5 V, 2 A
Carrier frequency.....	Audio channel 1: 1.00 MHz
	Audio channel 2: 1.67 MHz
	Audio channel 3: 2.33 MHz
	Audio channel 4: 3.00 MHz
	Audio channel 5: 3.67 MHz
Capacity of battery.....	2300 mAh
When mic. is continuously on.....	Approx. 7 hours

### Interface data

Connector.....	Ø 3.5 mm jack for auxiliary audio input
	USB port for charging

### Microphone

Type.....	Uni-directional electret condenser microphone
Sensitivity.....	-46 dBV/Pa
Frequency response.....	75 Hz ~ 20 kHz
input resistance.....	680 Ω
Directivity 0°/180°.....	> 20 dB (1 kHz)
Equivalent noise.....	20 dBA (SPL)
Maximum sound pressure level.....	115 dB (THD < 3%)

### Mechanical

Dimensions (h x w x d).....	145 x 41 x 22 mm
Color.....	White (PANTONE 420 C)
Weight.....	80 g

## Ordering Information

TES-5604N_W.....	Digital Infrared Wireless Microphone (white, built-in rechargeable lithium battery, with laser pointer, excl. adapter, used with TES-5600NS_W neck lanyard or TES-5600CLP clip)
------------------	---



# TES-5608/20 Series Digital IR Smart Teaching Microphone



## Functions

- Original dirATC—digital infrared audio transmission and control technology
- Infrared transmitting carrier frequency conforms to IEC 61603-7, DQPSK digital modulation/demodulation technology
- Insusceptible to interferences from HF-driven lighting and works perfectly in sunlight
- Superior scalability, supporting audio input (Ø 3.5 mm AUDIO IN) from devices such as MP3 and mobile phone
- Volume adjustment of the microphone
- Remote control of PPT slides
- Supports laser pointer (TES-5608CN)
- Built-in digital laser pointer, with more functionalities when working with the software (TES-5608BN):
  - ◆ Multiple pointing modes: magnify, highlight, digital laser pointer, cross, and mouse cursor
  - ◆ Support content interaction via the cursor, such as playing video, opening links, etc.
- Transmitter powers off automatically when no voice is detected for a preset period of time
- Microphone channel adjustable
- TES-5608BN/20 or TES-5608CN/20 has a C type USB port on the top which can connect to and power the TES-5608AN
- TES-5608AN is a light-weight clip microphone, with an 1.5 meter USB cable for connecting to TES-5608BN/20 or TES-5608CN/20 and a clip for fitting on the lapel or necktie
- TES-5608BN/20 or TES-5608CN/20 is of ergonomically compact and elegant design, can be held in hand or hung around the neck via a nice strap or fit at the waist via a belt case
- Emission angle: vertical: 0°~ 90°, horizontal: 120°
- Emission range: linear transmitting distance: over 25 m
- Built-in rechargeable lithium battery, operation duration when microphone is continuously on about 7 hours
- TES-5608BN/20 or TES-5608CN/20 has a C type USB port, 5V DC, for charging
- TES-5608BN/20 or TES-5608CN/20 has two charging contacts, can be charged via charging station

## Controls and Indicators

- Power/ “...” button: Power/ select MIC/PPT mode button

- Microphone volume up/down button
- Microphone on (MIC) indicator
- PPT mode indicator
- Battery indicator
- Laser pointer button and transmitter

## Interconnections

- Ø 3.5 mm jack for auxiliary audio input
- Two charging contacts
- USB port for charging/ connecting to TES-5608AN

## Technical Specifications

### Electrical

IR transmission wavelength.....	870 nm
Modulation method.....	DQPSK
Power.....	DC 5 V, 2 A
Carrier frequency.....	Audio channel 1: 1.0 MHz
	Audio channel 2: 1.67 MHz
	Audio channel 3: 2.33 MHz
	Audio channel 4: 3.0 MHz
	Audio channel 5: 3.67MHz
Capacity of battery.....	2300 mAh
When mic. is continuously on.....	Approx. 7 hours

### Interface data

Connector.....	Ø 3.5 mm jack for auxiliary audio input
	USB port for charging/ connecting to microphone

### Microphone

Type.....	Uni-directional electret condenser microphone
Sensitivity.....	-46 dBV/Pa
Frequency response.....	75 Hz ~ 20 kHz
input resistance.....	680 Ω
Directivity 0°/180°.....	> 20 dB (1 kHz)
Equivalent noise.....	20 dBA (SPL)
Maximum sound pressure level.....	115 dB (THD < 3%)

### Mechanical

Color.....	dark red (TES-5608AN)
	space grey (TES-5608BN/CN)
Dimensions (h x w x d).....	47x43x14(TES-5608AN)
	41x13x123 (TES-5608BN/CN)
Weight.....	20 g (TES-5608AN)
	90 g (TES-5608BN/CN)

## Ordering Information

TES-5608AN.....	Digital Infrared Clip Microphone
TES-5608BN/20.....	Digital Infrared Wireless Presenter (space grey, with digital laser pointer, built-in rechargeable lithium battery, with neck lanyard and belt case, with TSW-5608B Setup Tool, excl. adapter)
TES-5608CN/20.....	Digital Infrared Wireless Presenter (space grey, with laser pointer, built-in rechargeable lithium battery, with neck lanyard and belt case, excl. adapter)

**TES-5600MIC  
Wired Desktop Microphone**



**Features**

- Standard stem microphone
- 1 audio cable with USB port for connecting to main unit/ control box to transmit audio
- 1 microphone on/off button
- Dimensions (h x w x d, without stem): 43x135x132 mm
- Color: black (PANTONE 419 C)
- Weight: 0.5 kg

**Ordering Information**

TES-5600MIC.....Wired Desktop Microphone (standard stem microphone: 60cm, optional: 50/70cm)

**TES-5600CSMN  
Wired Desktop Microphone**



**Features**

- Standard stem microphone
- 1 audio cable with USB port for connecting to main unit/ control box to transmit audio
- 1 microphone on/off button
- 1 lockable charging station for one TES-5604 microphone
- Support connecting to central control system via RS232 for unlocking microphone
- Support network management for unlock microphone, microphone status display, setting classroom information
- 1 USB port for connecting to TES-ADP5V adapter
- Dimensions (h x w x d, without stem): 53x135x132 mm
- Color: black (PANTONE 419 C)
- Weight: 0.6 kg

**Ordering Information**

TES-5600CSMN.....Wired Desktop Microphone (standard stem microphone: 60cm, optional: 50/70cm; with a lockable charging station for one TES-5604/5608 series microphone, can be unlocked via central control system or via network management system; support network management when used with TES-5604NSW Classroom Audio System Management Platform with TES- ADP5V power adapter)

**TES-5600CSML  
Wired Desktop Microphone**



**Features**

- Standard stem microphone
- 1 audio cable with USB port for connecting to main unit/ control box to transmit audio
- 1 microphone on/off button
- 1 lockable charging station for one TES-5604 microphone
- Support connecting to central control system via RS232 for unlocking microphone
- Support unlocking via scanning QR code
- 1 USB port for connecting to TES-ADP5V adapter
- Dimensions (h x w x d, without stem): 53x135x132 mm
- Color: black (PANTONE 419 C)
- Weight: 0.6 kg

**Ordering Information**

TES-5600CSML.....Wired Desktop Microphone (standard stem microphone: 60cm, optional: 50/70cm; with a lockable charging station for one TES-5604/ TES-5608 series microphone, can be unlocked by scanning QR code or via central control system; with TES- ADP5V power adapter)

**TES-5600CSM  
Wired Desktop Microphone**



**Features**

- Standard stem microphone
- 1 audio cable with USB port for connecting to main unit/ control box to transmit audio
- 1 microphone on/off button
- 2 charging stations for TES-5604 microphones
- 1 USB port for connecting to TES-ADP5V adapter
- Dimensions (h x w x d, without stem): 53x135x132 mm
- Color: black (PANTONE 419 C)
- Weight: 0.6 kg

**Ordering Information**

TES-5600CSM.....Wired Desktop Microphone (standard stem microphone: 60cm, optional: 50/70cm; with a charging station for two TES-5604/ TES-5608 series microphones, with TES-ADP5V power adapter)

## MS50/60/70EGD2B Stem Microphone



---

### Features

- Built-in windshield
- With 2 flexible parts
- Used for TES-5600 series Wired Desktop Microphone
- Stem length: 50/60/70 cm
- Microphone
  - ◆ Type: Uni-directional electret condenser microphone
  - ◆ Sensitivity: -46 dBV/Pa
  - ◆ Frequency response: 75 Hz ~ 20 kHz
  - ◆ input resistance: 680 Ω
  - ◆ Directivity 0°/180°: > 20 dB (1 kHz)
  - ◆ Equivalent noise: 20 dBA (SPL)
  - ◆ Maximum sound pressure level: 115 dB (THD < 3%)
- Color: black (PANTONE 419 C)
- Weight: MS50EGD2B (102 g)
  - MS60EGD2B (105 g)
  - MS70EGD2B (107 g)

---

### Ordering Information

MS50EGD2B.....	Stem Microphone (50 cm, built-in windshield, flexible gooseneck tube, for TES-5600 series Wired Desktop Microphone, black)
MS60EGD2B.....	Stem Microphone (60 cm, built-in windshield, flexible gooseneck tube, for TES-5600 series Wired Desktop Microphone, black)
MS70EGD2B.....	Stem Microphone (70 cm, built-in windshield, flexible gooseneck tube, for TES-5600 series Wired Desktop Microphone, black)

## TES-5675T Hanging Microphone



### Features

- Built-in directional electret microphone to pick up the audio of the teachers' lecture
- Pickup distance: 5 m
- 1 3PIN Phoenix interface for analog audio output and power supply, can be connected to the MIC1/2 interface of main unit TES-5600MRN /MHN or TES-8100MA/MB with built-in high-performance digital signal processor (DSP) for feedback suppression (AFC), noise cancellation (ANC) and automatic gain control (AGC) function
- Highly integrated, easy to install

### Technical Specifications

#### Electrical

Microphone: .....14mm Cardioid unidirectional microphone  
 Sensitivity:..... -30 dBV/Pa  
 Frequency response:..... 50 ~ 20000 Hz  
 Directivity 0°/180° :..... > 20 dB (1 kHz)  
 Equivalent noise :..... 20 dBA (SPL)  
 Maximum sound pressure :..... 125 dB (THD<3%)  
 Phantom power requirements..... DC 11 V - 52 V, 2 mA  
 Output impedance ..... 230 Ω  
 SNR:..... ≥65.5 dBA  
 Total harmonic distortion..... ≤0.1%

#### Mechanical

Dimensions (mm) :..... Ø 124 × 53 (height)  
 Color :..... Gray  
 Weight: ..... 140 g

### Ordering Information

TES-5675T.....Hanging Microphone (Gray, round, 14mm Cardioid unidirectional microphone, pick up the audio of the teachers' lecture)

## TES-5675S Hanging Microphone



### Features

- Built-in omnidirectional electret microphone to pick up students' interactive sounds
- Pickup range: 5 m radius with medium ambient noise  
8 m radius in a quiet environment
- 1 3PIN Phoenix interface for analog audio output and power supply, can be connected to the MIC1/2 interface of main unit TES-5600MRN /MHN or TES-8100MA/MB with built-in high-performance digital signal processor (DSP) for feedback suppression (AFC), noise cancellation (ANC) and automatic gain control (AGC) function
- Highly integrated, easy to install

### Technical Specifications

#### Electrical

Microphone: .....Omnidirectional microphone  
 Sensitivity: ..... -32 dBV/Pa  
 Frequency response :..... 50 ~ 20000 Hz  
 Directivity 0°/180° : ..... > 20 dB (1 kHz)  
 Equivalent noise: ..... 20 dBA (SPL)  
 Maximum sound pressure: ..... 125 dB (THD<3%)  
 Phantom power supply: ..... DC 11 ~ 52 V, 2mA  
 Output impedance : ..... 230 Ω  
 SNR: ..... ≥65.5 dBA  
 Total harmonic distortion..... ≤0.1%

#### Mechanical

Dimensions (mm) :..... Ø 124 × 53 (height)  
 Color :..... Gray  
 Weight: ..... 140 g

### Ordering Information

TES-5675S.....Hanging Microphone (Gray, round, omnidirectional microphone, pick up students' interactive audio)

## TES-5675H Hanging Microphone



### Features

- Stylish and ergonomic design
- Built-in cardioid uni-directional electret condenser microphone to pick up the audio of the teachers' lecture
- Microphone: 14 mm cardioid unidirectional electret condenser
- Pickup distance: 5 m
- Built-in high-performance digital signal processor (DSP), noise cancellation (ANC) and automatic gain control (AGC) for the picked up audio
- Super anti-interference ability of mobile phones
- Simple and rapid installation: The microphone terminal is a standard 3-pin XLR male XLRM, used for analog audio output and power supply, can be connected to any 3-pin XLRF-type socket or directly to the sound mixing console, and can also be connected to the MIC1/2 interface of main unit TES-5600MRN /MHN or TES-8100MA/MB with built-in high-performance digital signal processor (DSP) for feedback suppression (AFC), noise cancellation (ANC) and automatic gain control (AGC) function
- Low-impedance balanced audio output, the audio signal is output through the XLR male output terminal's No.2 and No.3 pins (No.2 pin is for positive phase level, No.3 pin is for negative phase level), while No.1 is Ground wire (shield) connection

### Technical Specifications

#### Electrical

Microphone: .....14mm Cardioid unidirectional microphone  
 Sensitivity:.....-32 dBV/Pa  
 Frequency response:.....50 ~ 20000 Hz  
 Directivity 0°/180° :.....> 20 dB (1 kHz)  
 Equivalent noise :.....20 dBA (SPL)  
 Maximum sound pressure :.....139 dB (THD<3%)  
 Phantom power requirements.....DC 11 V - 52 V, 2 mA  
 Output impedance :.....280 Ω  
 SNR :.....≥65.5 dBA  
 Total harmonic distortion:.....≤0.1%

#### Mechanical

Dimensions (mm) :.....Ø 20 x 150  
 Color :.....Black  
 Weight: :.....140 g

### Ordering Information

TES-5675H.....Hanging Microphone (Black, 14mm Cardioid unidirectional microphone , pick up the audio of the teachers' lecture)

## TES-5600RN/30 Digital Infrared Receiver



### Functions

- World pioneering digital infrared wireless lecturing system
- Based on TAIDEN originated dirATC-digital infrared Audio Transmitting and Control technologies
- Excellent immunity to RF interferences from HF-driven lighting and it works perfectly in sunlight
- Support 2 wireless microphones
- Reception angle: vertical: 150° (±75°), horizontal: 360°
- Emission range: linear transmitting distance: over 25 m  
covered range: 80 to 100 m<sup>2</sup>

### Indicators

- Power indicator

### Interconnections

- 1 RJ45 interface for connection with main unit via CBLRJ45 Ethernet Extension Cable

### Technical Specifications

#### Electrical

Wavelength.....870 nm  
 Modulation method.....DQPSK  
 Voltage.....12 V DC (supplied from main unit or control box)

#### Mechanical

Mounting.....Ceiling, wall or tripod mounting  
 Dimensions.....60 × Ø 116 mm  
 Weight.....220 g  
 Color.....Red (PANTONE 476)

### Ordering Information

TES-5600RN/30.....Digital Infrared Receiver (RJ45 interface, ceiling, wall or tripod-mounted, supports 2 wireless microphones)

## TES-5600RN1/30 Digital Infrared Receiver



---

### Functions

- World pioneering digital infrared wireless lecturing system
- Based on TAIDEN originated dirATC-digital infrared Audio Transmitting and Control technologies
- Excellent immunity to RF interferences from HF-driven lighting and it works perfectly in sunlight
- Support one wireless microphone
- Reception angle: vertical: 150° (±75°), horizontal: 360°
- Emission range: linear transmitting distance: over 25 m  
covered range: 80 to 100 m<sup>2</sup>

### Indicators

- Power indicator

### Interconnections

- 1 RJ45 interface for connection with main unit via CBLRJ45 Ethernet Extension Cable

---

### Technical Specifications

#### Electrical

Wavelength.....870 nm  
 Modulation method.....DQPSK  
 Voltage.....12 V DC (supplied from main unit or control box)

#### Mechanical

Mounting.....Ceiling, wall or tripod mounting  
 Dimensions.....60 × Ø 116 mm  
 Weight.....220 g  
 Color.....Red (PANTONE 476)

---

### Ordering Information

TES-5600RN1/30.....Digital Infrared Receiver (RJ45 interface, ceiling, wall or tripod-mounted, supports 1 wireless microphones)



# TES-5600BX1/30 Digital Infrared Classroom Audio System Control Box



## Functions

- Original dirATC-digital infrared Audio Transmitting and Control technologies for steady reproduction of crystal-clear sound
- Infrared transmitting carrier frequency conforms to IEC 61603-7, DQPSK digital modulation/demodulation technology
- Supports 1 wireless microphones
- 2 RJ45 for digital infrared wireless receiver
- 2 PC IN (adjustable volume), 1 LINE OUT
- Built-in amplifier, support 4 loudspeakers
- 1 Micro USB interface for remote control of PPT slides
- 1 A type USB interface for connecting to TES-5600MIC or TES-5600CSM series wired microphone for audio transmission

## Controls and Indicators

- 1 volume knob for speakers
- 3 knobs for MIC volume, bass and treble
- Power switch with indicator

## Interconnections

- 2 x 3.5 mm interface for PC IN with volume knob
- 1 x 3.5 mm interface for LINE OUT
- 1 A type USB interface for TES-5600MIC or TES-5600CSM series wired microphone
- 1 Micro USB interface for connecting to PC
- 2 RJ45 interface for connection to TES-5600RN/30 series Digital Infrared Receiver
- DC power supply

## Technical Specifications

### Electrical

Power supply.....	24 V DC
Modulation method.....	DQPSK
Carrier frequency.....	Audio channel 1: 2.33 MHz
	Audio channel 2: 3.67 MHz
Frequency response.....	main unit to main unit: 50 Hz to 20 kHz
	Mic. to main unit: 100 Hz to 20 kHz
SNR.....	Mic. to main unit: ≥90 dBA
THD.....	Mic. to main unit: ≤0.05%
Dynamic range.....	Mic. to main unit: ≥85 dB
Audio Power Amplifier	
Max. output power.....	60 W×2 (8 Ohm)
	30 W×4 (8 Ohm)

### Mechanical

Dimensions (h x w x d).....	41 x 168 x 123 mm
Weight.....	0.4 kg
Color.....	Black (PANTONE 419 C)

## Ordering Information

TES-5600BX1/30.....	Digital Infrared Classroom Audio System Control Box (with RJ45 interface, supports 1 wireless microphone, built-in audio power amplifier can be connected to 4 loudspeakers, can connect to TES-5600 series Wired Desktop Microphone for audio transmission, 2 line in, 1 line out, with adapter)
---------------------	---

# TES-5600BX2/30 Digital Infrared Classroom Audio System Control Box



## Functions

- Original dirATC-digital infrared Audio Transmitting and Control technologies for steady reproduction of crystal-clear sound
- Infrared transmitting carrier frequency conforms to IEC 61603-7, DQPSK digital modulation/demodulation technology
- Supports 2 wireless microphones
- 2 RJ45 for digital infrared wireless receiver
- 2 PC IN (adjustable volume), 1 LINE OUT
- Built-in amplifier, support 4 loudspeakers
- 1 Micro USB interface for remote control of PPT slides
- 1 A type USB interface for connecting to TES-5600MIC or TES-5600CSM series wired microphone for audio transmission

## Controls and Indicators

- 1 volume knob for speakers
- 3 knobs for MIC volume, bass and treble
- Power switch with indicator

## Interconnections

- 2 x 3.5 mm interface for PC IN with volume knob
- 1 x 3.5 mm interface for LINE OUT
- 1 A type USB interface for TES-5600MIC or TES-5600CSM series wired microphone
- 1 Micro USB interface for connecting to PC
- 2 RJ45 interface for connection to TES-5600RN/30 series Digital Infrared Receiver
- DC power supply

## Technical Specifications

### Electrical

Power supply.....	24 V DC
Modulation method.....	DQPSK
Carrier frequency.....	Audio channel 1: 2.33 MHz
	Audio channel 2: 3.67 MHz
Frequency response.....	main unit to main unit: 50 Hz to 20 kHz
	Mic. to main unit: 100 Hz to 20 kHz
SNR.....	Mic. to main unit: ≥90 dBA
THD.....	Mic. to main unit: ≤0.05%
Dynamic range.....	Mic. to main unit: ≥85 dB
Audio Power Amplifier	
Max. output power.....	60 W×2 (8 Ohm)
	30 W×4 (8 Ohm)

### Mechanical

Dimensions (h x w x d).....	41 x 168 x 123 mm
Weight.....	0.4 kg
Color.....	Black (PANTONE 419 C)

## Ordering Information

TES-5600BX2/30.....	Digital Infrared Classroom Audio System Control Box (with RJ45 interface, supports 2 wireless microphones, built-in audio power amplifier can be connected to 4 loudspeakers, can connect to TES-5600 series Wired Desktop Microphone for audio transmission, 2 line in, 1 line out, with adapter)
---------------------	--

**System Connection for TES-5600BX Series**

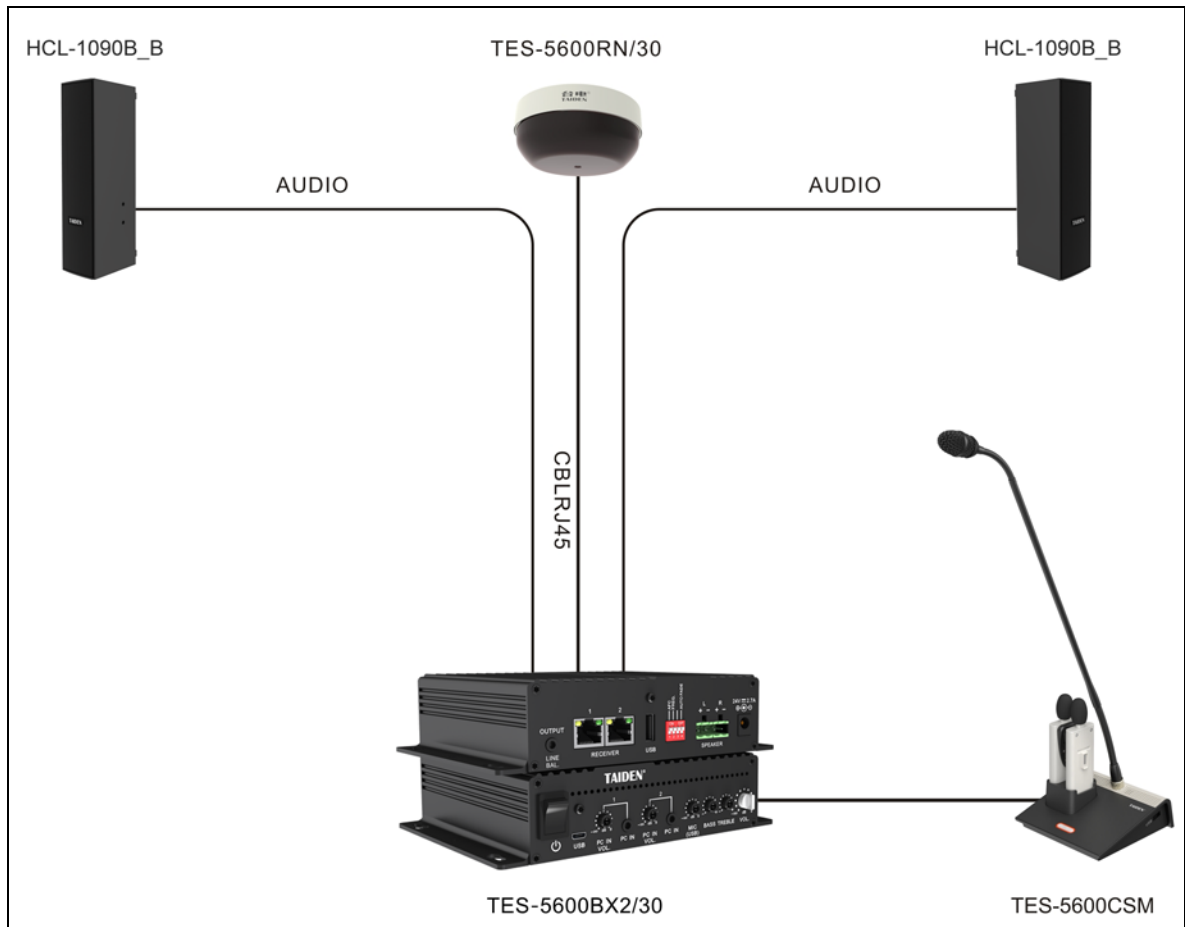

# TES-5600MAU/30 Digital Infrared Classroom Audio System Main Unit



## Functions

- Original dirATC-digital infrared Audio Transmitting and Control technologies for steady reproduction of crystal-clear sound
- Infrared transmitting carrier frequency conforms to IEC 61603-7, DQPSK digital modulation/demodulation technology
- Supports 2 wireless microphones
- Built-in amplifier, 4 speaker ports
- B type USB interface for digital audio input/output and remote control of PPT slides via connecting to PC
- A type USB for connecting to TES-5600MIC or TES-5600CSM series wired microphone for audio transmission
- Connection to central control system through RS232 interface for centralized control
- Multiple Emergency Alarms
  - ◆ Alarm can be triggered by either emergency switch on the main unit, central system or by pendant microphone to meet different needs of the customers
  - ◆ After the alarm is activated, emergency signal can be transmitted to central system. The signal can also control the electrical level to connect relay or alarm devices of the third party, which is highly flexible
  - ◆ The speaker can trigger the alarm by pendant microphone unnoticed and send the emergency signal to campus security center
- 1U high & half rack width

## Controls and Indicators

- OLED displays status and menu of the system configuration, supporting multi language menu
- 1 knob for configuration
- Power switch with indicator

## Interconnections

- Multiple audio in/out interfaces:
  - ◆ 2 audio LINE IN (Ø6.4 mm, LINE IN 1 can offer phantom power when being used for microphone input)
  - ◆ 2 audio LINE OUT (Ø6.4 mm)
  - ◆ 4 speaker ports
- DC power supply
- 2 RJ45 for connection to TES-5600RN/30 series Digital Infrared Receivers
- RS232 interface for connection to central control system
- 1 B type USB interface for digital audio input/output and remote control of PPT slides
- 1 A type USB for connecting to TES-5600MIC or TES-5600CSM series wired microphone for audio transmission

## Technical Specifications

### Electrical

Power supply	24 V DC
Modulation method	DQPSK
Carrier frequency	Audio channel 1: 2.33 MHz Audio channel 2: 3.67 MHz
Frequency response	main unit to main unit: 50 Hz to 20 kHz Mic. to main unit: 100 Hz to 20 kHz
SNR	Mic. to main unit: ≥90 dBA
THD	Mic. to main unit: ≤0.05%
Dynamic range	Mic. to main unit: ≥85 dB
Audio Power Amplifier	
Max. output power	60 W×2 (8 Ohm) 30 W×4 (8 Ohm)

### Interface data

Receiver terminal	RJ45 × 2
External control terminal	3.81 mm Phoenix connectors

### Mechanical

Mounting	Tabletop or mounted in a 19" rack
Dimensions (h x w x d)	55 x 211 x 236 mm (1U high & half rack width)
Weight	1.3 kg
Color	Black (PANTONE 419 C)

## Ordering Information

TES-5600MAU/30	Digital Infrared Classroom Audio System Main Unit (supports 2 wireless microphones, built-in amplifier, supports 4 speakers, can connect to TES-5600 series Wired Desktop Microphone for audio transmission, USB interface for digital audio input/output, phantom power, RJ45 interface to extend receiver, with adapter)
----------------	--

**System Connection for TES-5600MAU/30**

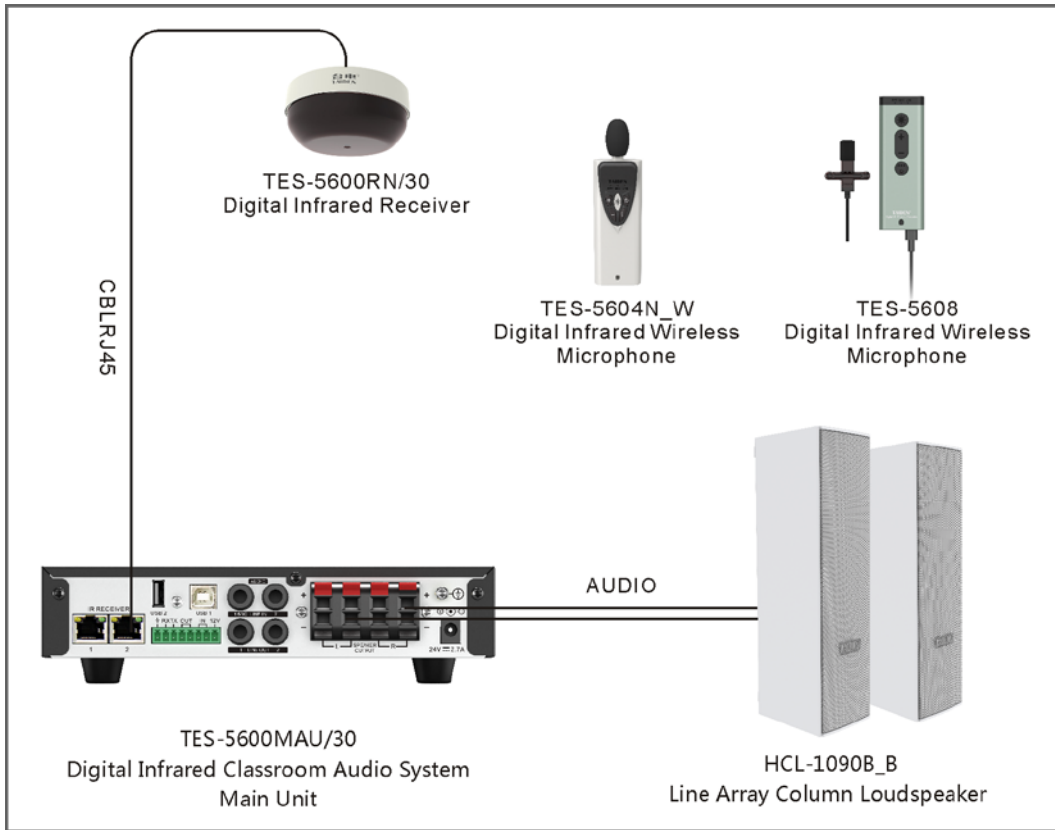

## TES-5630MA Economical Digital Infrared Classroom Audio System



### Functions

- Original dirATC-digital infrared Audio Transmitting and Control technologies for steady reproduction of crystal-clear sound
- Infrared transmitting carrier frequency conforms to IEC 61603-7, DQPSK digital modulation/demodulation technology
- Integrates the digital infrared wireless system main unit and the digital infrared receiver
- Supports 1 wireless microphones
- Built-in amplifier, 2 speaker ports

### Controls and Indicators

- 1 adjustment for master volume
- 1 adjustment for bass
- 1 adjustment for treble
- 1 FB suppress switch
- 1 Line In auto fade switch

### Interconnections

- Audio in/out interfaces:
  - ◆ 1 audio LINE IN (Ø 3.5 mm)
  - ◆ 1 audio LINE OUT (Ø 3.5 mm)
- DC power supply
- 1 BNC sockets for connection to extended TES-5600R series Digital Infrared Receiver
- 2 speaker output interfaces

### Technical Specifications

#### Electrical

Power supply.....	24 V DC
Modulation method.....	DQPSK
Carrier frequency.....	Audio channel 1: 1.67 MHz
	Audio channel 2: 2.33 MHz
	Audio channel 3: 3.0 MHz
Frequency response.....	main unit to main unit: 50 Hz to 20 kHz
	Mic. to main unit: 100 Hz to 20 kHz
SNR.....	Mic. to main unit: ≥90 dBA
THD.....	Mic. to main unit: ≤0.05%
Dynamic range.....	Mic. to main unit: ≥85 dB
Max. output power.....	30 W×2 (8 Ohm)

#### Mechanical

Mounting.....	Ceiling, wall or tripod mounting
Dimensions (h x w x d).....	150 x 146 x 66 mm
Weight.....	0.6 kg
Color.....	Silver (PANTONE 428C)

### Ordering Information

TES-5630MA.....	Economical Digital Infrared Classroom Audio System (with digital infrared receiver, supports 1 wireless microphone, built-in amplifier, supports 2 loudspeakers, with adapter)
-----------------	--

**System Connection for TES-5630MA**

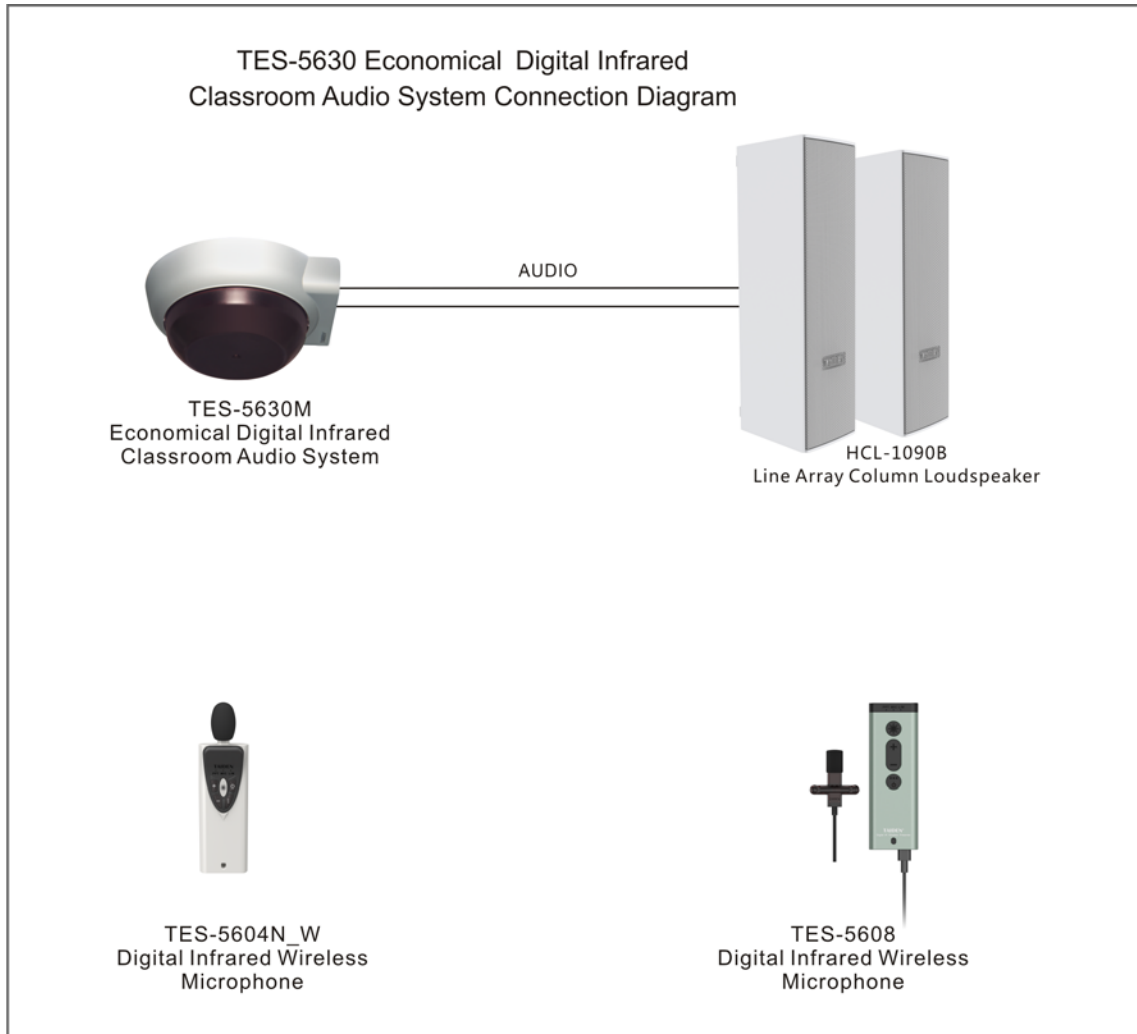







## TES-5685MC-F/30 Digital Infrared Classroom Audio System



### System features

- Original dirATC-digital infrared Audio Transmitting and Control technologies for steady reproduction of crystal-clear sound
- Infrared transmitting carrier frequency conforms to IEC 61603-7, DQPSK digital modulation/demodulation technology
- Selectable infrared carrier frequency for simultaneous use of one wireless microphone
- Built-in digital audio power amplifier and speakers for easy sound reinforcement:
- 1 RJ45 socket for analog audio signals input/output
- 1 RJ45 interface for connection to TES-5600RN/30 series Digital Infrared Receiver
- Volume of speakers is adjustable
- Bass and Treble are adjustable
- Supports remote PPT slides
- Highly integrated, and easy to install

### Controls and Indicators

- Switch:
  - ◆ F1.: select IR frequency
  - ◆ F2: set broadcast mode
  - ◆ AFC: set AFC function
  - ◆ AUTO FADE on: reduce line in volume automatically when the IR microphone is on
- Bass and Treble adjustment knob
- Volume control knob

### Interconnections

- RJ45 socket (RECEIVER) for connection to TES-5685BX series control box
- Micro USB interface for connecting to computer
- RJ45 interface for connecting TES-5600RN/30 series receiver

### Technical Specifications

#### Electrical

Power supply	AC 100-240 V, 1.5 A
Modulation method	DQPSK
Carrier frequency	Audio channel 1: 1.67 MHz Audio channel 2: 2.33 MHz Audio channel 3: 3.0 MHz
Frequency response	main unit to main unit: 50 Hz to 20 kHz Mic. to main unit: 100 Hz to 20 kHz
SNR	Mic. to main unit: ≥90 dBA
THD	Mic. to main unit: ≤0.05%
Dynamic range	Mic. to main unit: ≥85 dB
Emission angle	vertical: 150° (±75°), horizontal: 360°
IR radiation range:	
Line-of-sight distance	25 m

#### Mechanical

Speaker interface	Max. 4×30 W (12 Ohm)
Dimension (h x w x d, mm)	206 x 332 x 319
Color	White (PANTONE 420 C)
Weight	3.5 kg

### Ordering Information

TES-5685MC-F/30	Digital Infrared Classroom Speaker (with digital infrared receiver, supports 1 wireless microphone, analog audio input/output, built-in audio power amplifier and integrated loudspeakers, RJ45 interface for extending receiver, Type F plug)
-----------------	--



**TES-5685BX/30  
Function Extension Box**



**Functions**

- Function extension box for TES-5685M
- 1 PC IN and 1 LINE OUT
- Volume of MIC. IN and LINE IN adjustable
- 1 RJ45 interface for connecting to 5685M to transmit audio
- 1 A type USB interface for connecting to TES-5600MIC or TES-5600CSM series wired microphone for audio transmission
- Dimensions (h x w x d): 30 x 105 x 82 mm
- Weight: 0.2 kg

**Ordering Information**

TES-5685BX/30.....Function Extension Box (for TES-5685M series, analog audio input/output, can connect to TES-5600 series Wired Desktop Microphone for audio transmission, 1 line out+1 line in)

**TES-5685BXP/30  
Function Extension Box**



**Functions**

- Function extension box for TES-5685M
- 1 PC in and 1 line out
- 1 input for public address system, when the PA trigger enabled, the audio of PA IN puts out to all outputs and all other inputs are muted
- Volume of MIC. IN and LINE IN adjustable
- 1 RJ45 interface for connecting to 5685M to transmit audio
- 1 A type USB interface for connecting to TES-5600MIC or TES-5600CSM series wired microphone for audio transmission
- Dimensions (h x w x d): 30 x 105 x 82 mm
- Weight: 0.2 kg

**Ordering Information**

TES-5685BXP/30.....Function Extension Box (for TES-5685M series, analog audio input/output, can connect to TES-5600 series Wired Desktop Microphone for audio transmission, 1 line out+1 line in, 1 PA in + 1 PA trigger)

**System Connection**

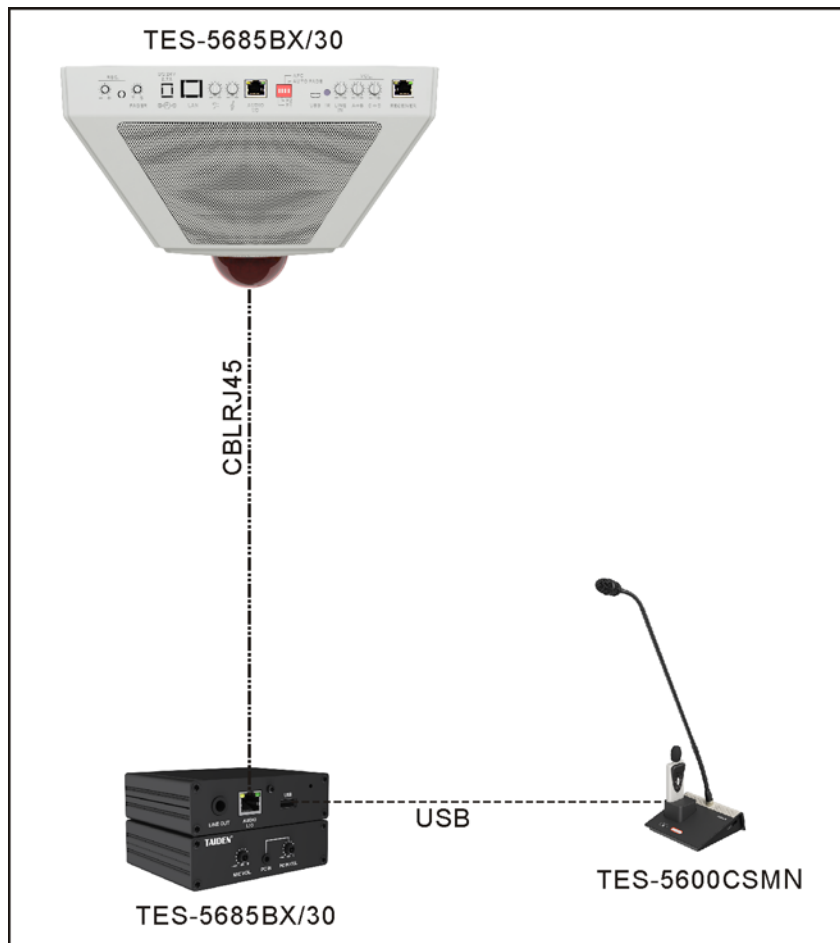

**Function List**

Type No.	TES-5685MB/30	TES-5685MC/30
IR microphone	2	1
Audio amplifier	•	•
Built-in speaker	•	•
LIEN IN/ LINE OUT	• (with TES-5685BX series)	• (with TES-5685BX series)
AUDIO I/O	•	•
Wired microphone	• (with TES-5685BX series)	• (with TES-5685BX series)
PA IN	• (with TES-5685BXP/30)	• (with TES-5685BXP/30)
PPT	•	•
Interface	RJ45	RJ45

# TES-5690MA

## Digital Infrared classroom Audio System Main Unit



### System features

- Original dirATC-digital infrared Audio Transmitting and Control technologies for steady reproduction of crystal-clear sound
- Infrared transmitting carrier frequency conforms to IEC 61603-7, DQPSK digital modulation/demodulation technology
- Built-in professional digital audio power amplifier, 4 speaker ports
- 2 RJ45 interface for connection to TES-5600RN/30 series Digital Infrared Receiver
- Selectable infrared carrier frequency for simultaneous use of 2 wireless microphones
- A type USB for connecting to TES-5600MIC or TES-5600CSM series wired microphone for audio transmission
- B type USB interface for digital audio input/output and remote control of PPT slides via connecting to PC
- 1 Analog line input (Ø 3.5mm, stereo), 1 Analog audio input (3-pin Phoenix, balanced, with phantom power), 1 Analog priority input (3-pin Phoenix, stereo), the volume of each channel is individually adjustable
- 1 Analog line output (3-pin Phoenix, stereo)
- 1 RS232 interface for connection to central control system
- The balance of the power amplifier output channel is adjustable, output power: 200 W × 2 + 60 W × 2
- Built-in DSP audio processor, support webpage control and management. The user can access the IP address of main unit from web browser to set parameters and view device status, e.g. compressor, equalizer, DRC, etc.
- Complete protection functions: short-circuit, DC, over-temperature protection, overload power control, over-temperature power control, etc.

### Interconnections

- ETHERNET (RJ45) interface for connecting to LAN/PC for web control and management
- RJ45 interface (IR RECEIVER) for connecting TES-5600RN/30 series Digital Infrared Receiver
- 1 type-B USB interface for digital audio input/output and remote control of PPT slides
- 1 type-A USB interface for connecting to TES-5600MIC or TES-5600CSM series wired microphone for audio transmission
- Multiple audio in/out interfaces:
  - ◆ 3 audio LINE IN
    - 1 Analog line input (Ø 3.5mm, stereo)
    - 1 Analog audio input (3-pin Phoenix, balanced, with phantom power) for microphone input
    - 1 Analog priority input (3-pin Phoenix, stereo)
  - ◆ 1 Analog line output (3-pin Phoenix, stereo)
  - ◆ 4 speaker ports available ( 2 FRONT + 2 REAR)
- 1 RS232 interface for connection to central control system

### Technical Specifications

#### Electrical

Power supply.....	AC 100 ~ 240 V, 3.0 ~ 1.5 A
Modulation method.....	DQPSK
Carrier frequency.....	Audio channel 1: 2.33 MHz Audio channel 2: 3.67 MHz
Frequency response.....	main unit to main unit: 50 Hz to 20 kHz Mic. to main unit: 100 Hz to 20 kHz
SNR.....	Mic. to main unit: ≥90 dBA
THD.....	Mic. to main unit: ≤0.05%
Dynamic range.....	Mic. to main unit: ≥85 dB

#### Mechanical

Speaker interface.....	200 W×2 (FRONT) 60 W×2 /6 Ω (REAR)
Dimension (h x w x d, mm).....	480×288×45
Color.....	Black (PANTONE 419 C)
Weight.....	4.3 kg

### Ordering Information

TES-5690MA.....	Digital Infrared Classroom Audio System Main Unit (supports 2 wireless microphones, with DSP, built-in audio power amplifier 2×200 W+2×60 W, central control interface)
-----------------	---

# TES-5690MB

## Digital Infrared classroom Audio System Main Unit



### System features

- Original dirATC-digital infrared Audio Transmitting and Control technologies for steady reproduction of crystal-clear sound
- Infrared transmitting carrier frequency conforms to IEC 61603-7, DQPSK digital modulation/demodulation technology
- Built-in professional digital audio power amplifier, the balance of the power amplifier output channel is adjustable, output power: 60 W×4
- Built-in DSP audio processor, support webpage control and management. The user can access the IP address of main unit from web browser to set parameters and view device status, e.g. compressor, equalizer, DRC, etc.
- Complete protection functions: short-circuit, DC, over-temperature protection, overload power control, over-temperature power control, etc.
- 1 RS232 interface for connection to central control system

### Interconnections

- RJ45 socket for connecting to LAN/PC for web control and management
- RJ45 interface (IR RECEIVER) for connecting TES-5600RN/30 series Digital Infrared Receiver
- 1 type-B USB interface for digital audio input/output and remote control of PPT slides
- 1 type-A USB interface for connecting to TES-5600MIC or TES-5600CSM series wired microphone for audio transmission
- Multiple audio in/out interfaces:
  - ◆ 3 audio LINE IN
    - 1 Analog line input (Ø 3.5mm, stereo)
    - 1 Analog audio input (3-pin Phoenix, balanced, with phantom power) for microphone input
    - 1 Analog priority input (3-pin Phoenix, stereo)
  - ◆ 1 Analog line output (3-pin Phoenix, stereo)
  - ◆ 2 SPEAKER (FRONT) ports available
- 1 RS232 interface for connection to central control system

### Technical Specifications

#### Electrical

Power supply.....	AC 100 ~ 240 V,3.0 ~ 1.5 A
Modulation method.....	DQPSK
Carrier frequency.....	Audio channel 1: 2.33 MHz Audio channel 2: 3.67 MHz
Frequency response.....	main unit to main unit: 50 Hz to 20 kHz Mic. to main unit: 100 Hz to 20 kHz
SNR.....	Mic. to main unit: ≥90 dBA
THD.....	Mic. to main unit: ≤0.05%
Dynamic range.....	Mic. to main unit: ≥85 dB

#### Mechanical

Speaker interface.....	200 W×2
Dimension (h x w x d, mm).....	480×288×45
Color.....	Black (PANTONE 419 C)
Weight.....	4.3 kg

### Ordering Information

TES-5690MB.....	Digital Infrared Classroom Audio System Main Unit (supports 2 wireless microphones, with DSP, built-in audio power amplifier 2x200 W,, central control interface)
-----------------	---

## TES-5690MC Digital Infrared classroom Audio System Main Unit



### System features

- Original dirATC-digital infrared Audio Transmitting and Control technologies for steady reproduction of crystal-clear sound
- Infrared transmitting carrier frequency conforms to IEC 61603-7, DQPSK digital modulation/demodulation technology
- Built-in professional digital audio power amplifier, the balance of the power amplifier output channel is adjustable, output power: 60 W×4
- Built-in DSP audio processor, support webpage control and management. The user can access the IP address of main unit from web browser to set parameters and view device status, e.g. compressor, equalizer, DRC, etc.
- Complete protection functions: short-circuit, DC, over-temperature protection, overload power control, over-temperature power control, etc.
- 1 RS232 interface can be connected to central control system

### Interconnections

- RJ45 socket for connecting to LAN/PC for web control and management
- RJ45 interface (IR RECEIVER) for connecting TES-5600RN/30 series Digital Infrared Receiver
- 1 type-B USB interface for digital audio input/output and remote control of PPT slides

- 1 type-A USB interface for connecting to TES-5600MIC or TES-5600CSM series wired microphone for audio transmission
- Multiple audio in/out interfaces:
  - ◆ 3 audio LINE IN
    - 1 Analog line input (Ø 3.5mm, stereo)
    - 1 Analog audio input (3-pin Phoenix, balanced, with phantom power) for microphone input
    - 1 Analog priority input (3-pin Phoenix, stereo)
  - ◆ 1 Analog line output (3-pin Phoenix, stereo)
  - ◆ 2 SPEAKER (FRONT) ports available
- 1 RS232 interface for connection to central control system

### Technical Specifications

#### Electrical

Power supply	AC 100 ~ 240 V 2.3 ~ 1.2 A
Modulation method	DQPSK
Carrier frequency	Audio channel 1: 2.33 MHz Audio channel 2: 3.67 MHz
Frequency response	main unit to main unit: 50 Hz to 20 kHz Mic. to main unit: 100 Hz to 20 kHz
SNR	Mic. to main unit: ≥90 dBA
THD	Mic. to main unit: ≤0.05%
Dynamic range	Mic. to main unit: ≥85 dB

#### Mechanical

Speaker interface	60 W×4 /6 Ω
Dimension (h x w x d, mm)	480×288×45
Color	Black (PANTONE 419 C)
Weight	4.3 kg

### Ordering Information

TES-5690MC	Digital Infrared Classroom Audio System Main Unit (supports 2 wireless microphones, with DSP, built-in audio power amplifier 4×60 W, central control interface)
------------	---



**System Connection**

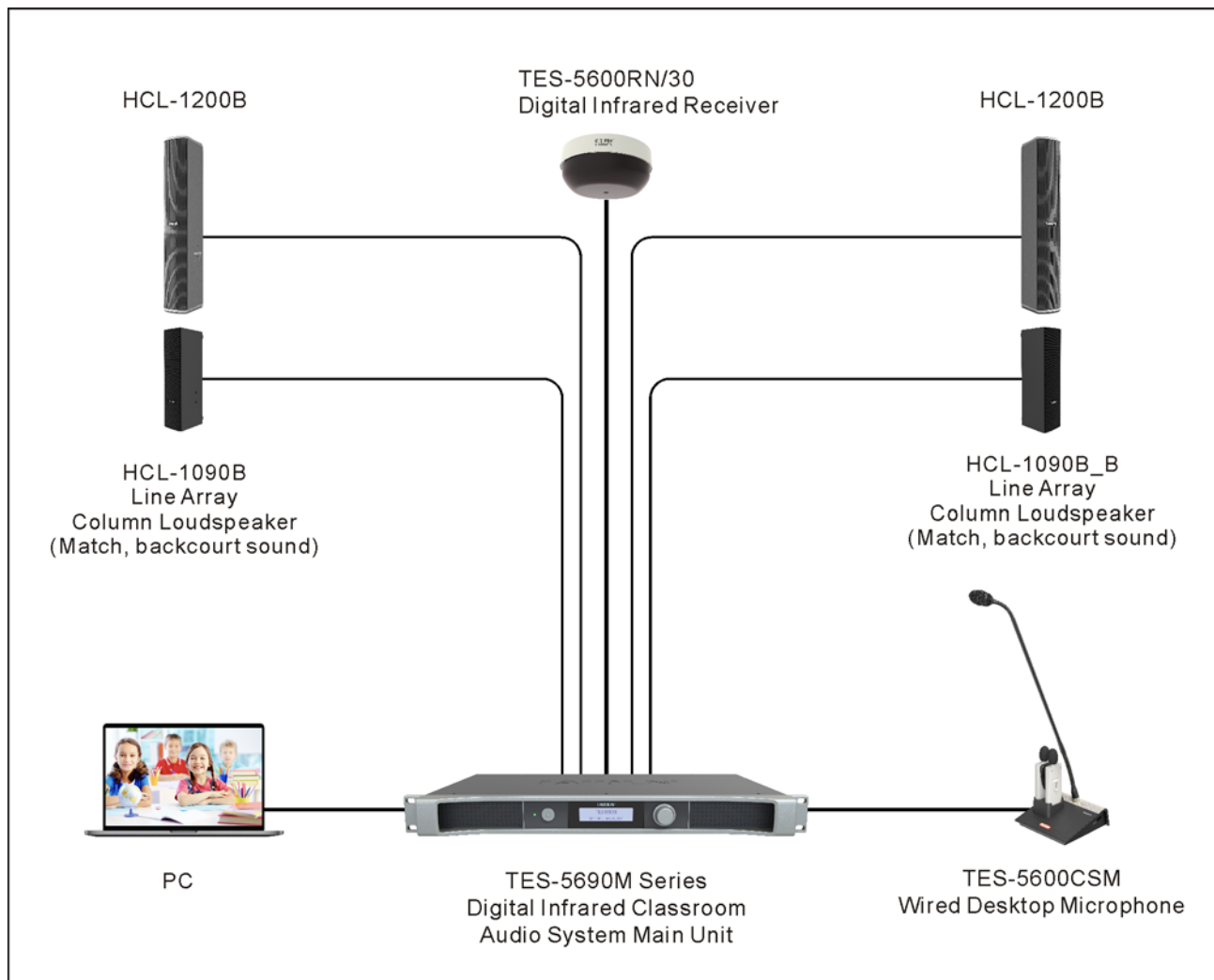

# TES-5600MRN Digital Infrared Classroom Audio System Main Unit



## Functions

- Original dirATC-digital infrared Audio Transmitting and Control technologies for steady reproduction of crystal-clear sound
- Infrared transmitting carrier frequency conforms to IEC 61603-7, DQPSK digital modulation/demodulation technology
- Built-in high-performance digital signal processor (DSP) with feedback suppression (AFC), echo canceller (AEC) for audio, and noise canceller (ANC) , automatic level control (ALC) function, and automatic equalizer (AEQ) function.
- Supports 2 wireless microphones
- Built-in amplifier, 4 speaker ports
- Cooperates with TES-560x microphones can Supports PPT Remote control of PPT slides (cooperate with), digital laser pointer (cooperate with TES-5608N)
- Support digital audio input and output via C type USB interface
- Remote Interactive function :1 remote interactive audio signal input (3PIN Phoenix REMOTE IN) and 1 remote interactive audio signal output (3PIN Phoenix, REMOTE OUT), with AEC function
- Can be used for normal recording and broadcasting through audio recording output (REC, Ø 3.5 mm)
- Support multiple use scenarios: 5 teaching sound reinforcement scenarios
- Connection with central control system via RS232 interface for centralized control

## Controls and Indicators

- OLED displays status and menu of the system configuration, supporting multi language menu
- 1 knob for configuration
- Power switch with indicator
- Dependent potentiometer for MIC.1/2/3

## Interconnections

- Multiple audio in/out interfaces:
  - ◆ 1 A type USB for connecting to TES-5600MIC or TES-5600CSM series wired microphone for audio transmission
  - ◆ 2 3PIN Phoenix interface with volume adjustment knob, used to extend connection to TES-5675 series Hanging microphones
  - ◆ 2 audio LINE IN (Ø6.4 mm, Balanced/differential)

- ◆ 2 audio LINE OUT (Ø6.4 mm, Balanced/differential)  
LINE OUT 2 can be connected to back-to-listening speakers, providing a better experience for teachers
- ◆ 1 remote interactive audio signal input for (3PIN Phoenix, REMOTE IN) and 1 remote interactive audio signal output (3PIN Phoenix, REMOTE OUT), with AEC function
- ◆ 4 speaker ports
- 2 RJ45 for connection to TES-5600RN/30 series Digital Infrared Receivers
- 1 RJ45 network interface, can be controlled and managed through the built-in Web and smart classroom system management platform
- 1 RS232 interface for connection to central control system
- 1 C type USB can be connected to PC

## Technical Specifications

### Electrical

Power supply.....	24 V DC
Modulation method.....	DQPSK
Carrier frequency.....	Audio channel 1: 2.33 MHz Audio channel 2: 3.67 MHz
Frequency response.....	main unit to main unit: 50 Hz to 20 kHz Mic. to main unit: 100 Hz to 20 kHz
SNR.....	Mic. to main unit: ≥90 dBA
THD.....	Mic. to main unit: ≤0.05%
Dynamic range.....	Mic. to main unit: ≥100 dB
Audio Power Amplifier	
Max. output power.....	60 W × 2 (8 Ohm) 30 W × 4 (8 Ohm)

### Interface data

Receiver terminal .....	RJ45 × 2
External control terminal.....	3.81 mm Phoenix connectors

### Mechanical

Mounting.....	Tabletop or mounted in a 19" rack
Dimensions (h x w x d).....	55 x 211 x 236 mm (1U high & half rack width)
Weight.....	1.3 kg
Color.....	Black (PANTONE 419 C)

## Ordering Information

TES-5600MRN...Digital Infrared Classroom Audio System Main Unit (with RJ45 interface, built-in Web , can be setup and managed by Digital Infrared Classroom System Management Platform, supports 2 wireless microphones and 2 hanging microphones, built-in audio power amplifier can be connected to 4 loudspeakers, can connect to TES-5600 series Wired Desktop Microphone for audio transmission, Type C USB interface for digital audio input/output, remote interaction, with adapter)

# TES-5600MHN

## Digital Infrared Classroom Audio System Main Unit



- ◆ 2 audio LINE OUT (Ø6.4 mm, Balanced/differential)  
LINE OUT 2 can be connected to back-to-listening speakers, providing a better experience for teachers
- ◆ 4 speaker ports
- 1 RJ45 network interface, can be controlled and managed through the built-in Web and smart classroom system management platform
- 2 RJ45 for connection to TES-5600RN/30 series Digital Infrared Receivers
- 1 RS232 interface for connection to central control system
- 1 C type USB can be connected to PC

### Functions

- Original dirATC-digital infrared Audio Transmitting and Control technologies for steady reproduction of crystal-clear sound
- Infrared transmitting carrier frequency conforms to IEC 61603-7, DQPSK digital modulation/demodulation technology
- Built-in high-performance digital signal processor (DSP) with feedback suppression (AFC), echo canceller (AEC) for audio, and noise canceller (ANC), automatic level control (ALC) function, and automatic equalizer (AEQ) function.
- Supports 2 wireless microphones
- Built-in amplifier, 4 speaker ports
- Cooperates with TES-560x microphones can Supports PPT Remote control of PPT slides (cooperate with), digital laser pointer (cooperate with TES-5608N)
- Support digital audio input and output via C type USB interface
- Can be used for normal recording and broadcasting through audio recording output (REC, Ø 3.5 mm)
- Support multiple use scenarios: 6 teaching sound reinforcement scenarios
- Connection with central control system via RS232 interface for centralized control

### Controls and Indicators

- OLED displays status and menu of the system configuration, supporting multi language menu
- 1 knob for configuration
- Power switch with indicator
- Dependent potentiometer for MIC.1/2/3

### Interconnections

- Multiple audio in/out interfaces:
  - ◆ 1 A type USB for connecting to TES-5600MIC or TES-5600CSM series wired microphone for audio transmission
  - ◆ 2 3PIN Phoenix interface with volume adjustment knob, used to extend connection to TES-5675 series Hanging microphones
  - ◆ 2 audio LINE IN (Ø6.4 mm, Balanced/differential)

### Technical Specifications

#### Electrical

Power supply.....	24 V DC
Modulation method.....	DQPSK
Carrier frequency.....	Audio channel 1: 2.33 MHz Audio channel 2: 3.67 MHz
Frequency response.....	main unit to main unit: 50 Hz to 20 kHz Mic. to main unit: 100 Hz to 20 kHz
SNR.....	Mic. to main unit: ≥90 dBA
THD.....	Mic. to main unit: ≤0.05%
Dynamic range.....	Mic. to main unit: ≥100 dB
Audio Power Amplifier	
Max. output power.....	60 W × 2 (8 Ohm) 30 W × 4 (8 Ohm)

#### Interface data

Receiver terminal .....	RJ45 × 2
External control terminal.....	3.81 mm Phoenix connectors

#### Mechanical

Mounting.....	Tabletop or mounted in a 19" rack
Dimensions (h x w x d).....	55 x 211 x 236 mm (1U high & half rack width)
Weight.....	1.3 kg
Color.....	Black (PANTONE 419 C)

### Ordering Information

TES-5600MHN.....Digital Infrared Classroom Audio System Main Unit (with RJ45 interface, built-in Web, can be setup and managed by Digital Infrared Classroom System Management Platform, supports 2 wireless microphones and 2 array microphones, built-in audio power amplifier can be connected to 4 loudspeakers, can connect to TES-5600 series Wired Desktop Microphone for audio transmission, Type C USB interface for digital audio input/output, with adapter)

System Connection

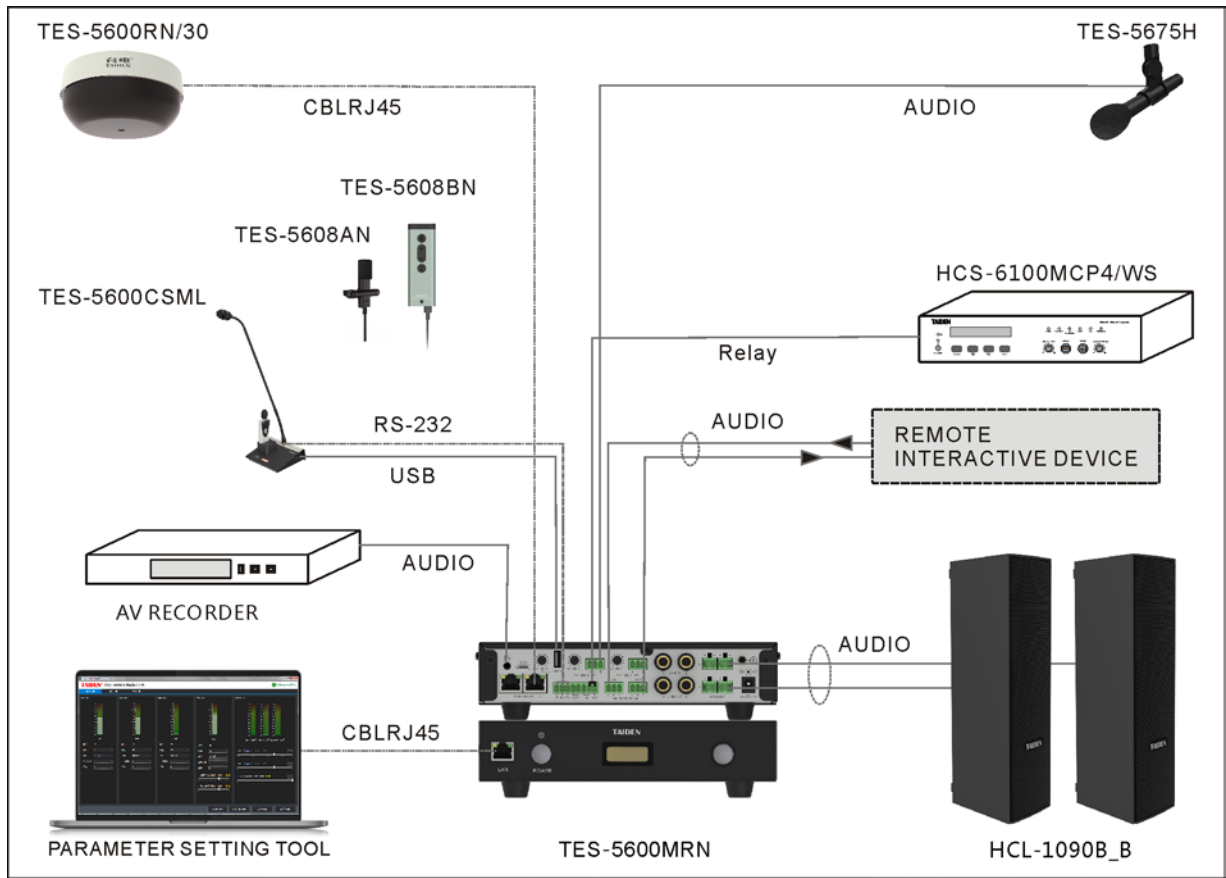

## TES-5600 series application software

TES-5600 series application software is comprehensive, reliable and user-friendly. The management platform is deployed in TES-8200S smart classroom system management server. The school administrator can easily access the platform by any PC and manage the digital infrared classroom audio system and other peripheral devices centrally and efficiently from the very beginning of devices installation. The operation turns out to be easy and efficient.

TES-5600 series application software can be divided into the following software:

- Digital Infrared Classroom Audio System Management Platform (TES-5600SW, support School Management, Device Management, Task Management, Logs, Setting and User management, can view status of wireless microphone/hanging microphone and setup audio parameter)



# TES-5600SW Digital Infrared Classroom Audio System Management Platform



## Functions

Supports various functions including School Management, Device Management, Task Management, Logs, Setting and User management. Through the platform, manager can view wireless microphone status, view and set the hanging microphone parameters, audio parameters setting and other functions.

### School Management

Supports 2 style: card view and list view, including Classroom list, Classroom status, School management, Statistics

#### Classroom list

Classroom	Building	Status	IP	Port	Device
Classroom 1	Building 1	Working	192.168.1.1	8080	TES-5600MRN
Classroom 2	Building 1	Standby	192.168.1.2	8080	TES-5600MRN
Classroom 3	Building 1	Offline	192.168.1.3	8080	TES-5600MRN
Classroom 4	Building 1	Low Battery	192.168.1.4	8080	TES-5600MRN
Classroom 5	Building 1	Working	192.168.1.5	8080	TES-5600MRN
Classroom 6	Building 1	Working	192.168.1.6	8080	TES-5600MRN
Classroom 7	Building 1	Working	192.168.1.7	8080	TES-5600MRN
Classroom 8	Building 1	Working	192.168.1.8	8080	TES-5600MRN
Classroom 9	Building 1	Working	192.168.1.9	8080	TES-5600MRN
Classroom 10	Building 1	Working	192.168.1.10	8080	TES-5600MRN

- Classroom list can view details of all classrooms, including physical location (classroom, building and device status and IP address), IOT status and control
- Switch between classrooms arbitrarily in the classroom list can view/control IOT and tasks
- Show details: IOT control can be realized including set / cancel microphone mute, set / cancel standby mode, unlock microphone remotely, etc.
- View custom designed tasks flow of the current day
- Config classroom: Platform provide a set of classroom configuration by default
- Configuration list contains device information, i.e. Name/ Group/ Device/ Brand/ Model etc.
- Configuration list support Add/Clear All/ Refresh/Delete/ modify and copy to other classroom operations

#### Classroom status

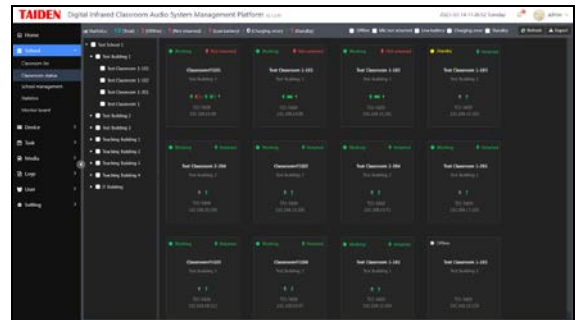

- Display status of all the classrooms that added to the platform, i.e. working status (working/standby/offline), microphone on/off status, battery, microphone return and charging status.
- Display status data statistics including total quantity of devices, quantity of device offline /not returned/ low battery)/ charging error/ Standby, etc.
- Support filtering function by selecting location or abnormal status

#### School Management

Building	Classroom	Status	Current number	Capacity	Management	Operation
Building 1	Classroom 1	Working	1	100	View	Edit
Building 1	Classroom 2	Standby	1	100	View	Edit
Building 1	Classroom 3	Offline	1	100	View	Edit
Building 1	Classroom 4	Low Battery	1	100	View	Edit

- Maintain (add/modify/delete) school/buildings/classrooms

#### Statistics

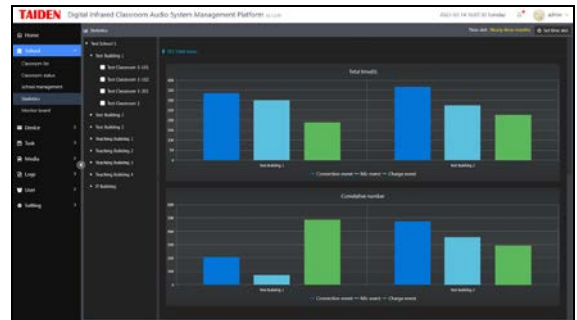

- Maintain (add/modify/delete) school/buildings/classrooms

### Device Management

#### Add device

- After setting IP and port of platform in built-in Webserver of TES-5600MRN/ TES-5600MHN/ TES-5690M main units, the platform will automatically synchronize the main units
- Manually input IP address

#### Assign location

- Assign the devices to different classrooms
- Export device list for initial installation and maintenance. The list contains multiple information of the devices, i.e. IP address/ Device type/ Name/ Alias/ Classroom/ Building/ Status/ Mic status/ Battery, etc.

◆ **Settings**



- ◆ Set input settings/ output settings/ system settings (Intelligent calibration for TES-5675 series hanging microphones) for TES-5600MRN/ TES-5600MHN/ TES-5690M

■ **Task Management**

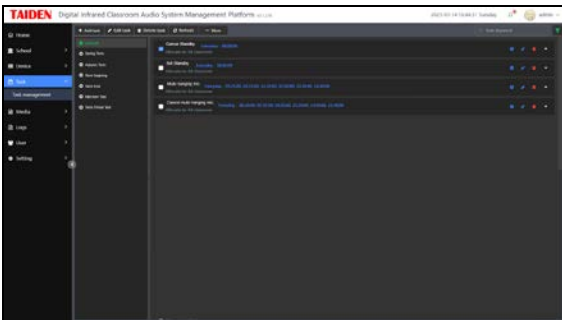

- ◆ Set tasks operated by platform automatically at specified time, (before/after class), i.e. set/cancel mute hanging microphone, set/cancel standby

■ **Logs**

- ◆ Keep 3 kinds of events of all devices: online/offline, start/finish charging, mic. on/off.
- ◆ Support search function: by specifying time or event type
- ◆ Logs can help with maintenance and debugging
- ◆ Logs can also be used for statistical data, such as hanging microphone use time, online time and charging time, etc.

■ **Setting**

- ◆ The platform provides a set of classroom configuration, including the device name and function list (control mode: WEBSOCKET; function: mute/cancel mute hanging microphone ,set/ cancel standby, unlock wireless microphone)

■ **User management**

- ◆ Including user management, role management, personal information
- ◆ User management login interface can register user , define their roles, and assign them different permissions.
- ◆ Different role have different permissions according to the authority to manage the designated building or classrooms
- ◆ User information can be modified

---

**Ordering Information**

TES-5600SW.....Digital Infrared Classroom Audio System Management Platform

# Interactive Audio Recording and Webcasting System





**Interactive Audio Recording and Webcasting System**

<b>Interactive Audio Recording and Webcasting System</b> .....	<b>2</b>
<b>TES-560x Series Digital Infrared Wireless Microphone</b> .....	<b>4</b>
TES-5604N_W Digital Infrared Wireless Microphone (white, built-in rechargeable lithium battery, excl. adapter, used with TES-5600NS series neck lanyard).....	4
TES-5606 Digital Infrared Wireless Microphone (built-in rechargeable lithium battery, excl. adapter, used with TES-5600NS series neck lanyard).....	5
TES-1021 Clip Microphone.....	6
TES-1022 Single-ear Microphone.....	6
TES-1023 Head-worn Microphone.....	6
<b>TES-5600 Series Wired Desktop Microphone</b> .....	<b>7</b>
TES-5600MIC Wired Desktop Microphone (standard stem microphone: 60cm, optional: 50/70cm).....	7
TES-5600CSMN Wired Desktop Microphone (standard stem microphone: 60cm, optional: 50/70cm; with a lockable charging station for one TES-5604 series microphone, can be unlocked via central control system or via network management system; support network management when used with TES-5604NSW Wireless Microphones Management Platform; with TES- ADP5V power adapter).....	7
TES-5600CSML Wired Desktop Microphone (standard stem microphone: 60cm, optional: 50/70cm; with a lockable charging station for one TES-5604 series microphone, can be unlocked by scanning QR code or via central control system; with TES- ADP5V power adapter).....	8
TES-5600CSM Wired Desktop Microphone (standard stem microphone: 60cm, optional: 50/70cm; with a charging station for two TES-5604 series microphones, with TES- ADP5V power adapter).....	8
MS50EGD2B Stem Microphone (50cm, built-in windshield, flexible gooseneck tube, for TES-5600 series Wired Desktop Microphone, black).....	9
MS60EGD2B Stem Microphone (60cm, built-in windshield, flexible gooseneck tube, for TES-5600 series Wired Desktop Microphone, black).....	9
MS70EGD2B Stem Microphone (70cm, built-in windshield, flexible gooseneck tube, for TES-5600 series Wired Desktop Microphone, black).....	9
<b>TES-568x Series Classroom Audio System</b> .....	<b>10</b>
TES-5680M/30 Interactive Audio Recording System Receiver (with built-in array microphone, high performance DSP with ANC, AEC and AGC algorithm, with digital infrared receiver).....	10
TES-5680BX/30 Interactive Audio Recording System Control Box (supports 2 wireless microphones, 1 line in, 1 line out + 1 output for recording, digital audio input/output (micro USB), built-in audio power amplifier for connection to 4 loudspeakers, with TES-ADP24V adapter).....	10
TES-5685MA-F/30 Interactive Audio Recording System Main Unit (with built-in array microphone, high performance DSP with ANC, AEC and AGC algorithm, audio localization, with digital infrared receiver, supports 2 wireless microphones, with analog audio input/output, output for recording, built-in audio power amplifier and integrated loudspeakers, RJ45 interface for extending receiver, Type F plug).....	12
TES-5685MA-B/30 Interactive Audio Recording System Main Unit (with built-in array microphone, high performance DSP with ANC, AEC and AGC algorithm, audio localization, with digital infrared receiver, supports 2 wireless microphones, with analog audio input/output, output for recording, built-in audio power amplifier and integrated loudspeakers. RJ45 interface for extending receiver. Type B plug)	14
TES-5685BX/30 Function Extension Box (for TES-5685M, analog audio input/output, can connect to TES-5604CS series charging station, with 1 line in and 1 line out).....	16
TES-5685BXP/30 Function Extension Box (for TES-5685M series, analog audio input/output, 1 line out+1 line in, 1 input for public address system, 1 PA trigger, can connect to TES-5604CS series charging station).....	16

## Interactive Audio Recording and Webcasting System

### System overview

TAIDEN, the world's leading supplier of conference system equipment, has successfully equipped many international conference projects such as the United Nations Headquarters, the Council of Europe, G20 summit, APEC summit and ASEM summit. As early as in 2008, TAIDEN developed the digital infrared processing chip, based on which it built the digi and invented the digital infrared conference system, making itself stand out from other rivals.

In 2015, TAIDEN introduced its worldwide pioneering digital infrared technology into the field of multimedia teaching and released the world's first digital infrared wireless classroom audio system. The system provides an ideal solution for teaching environment owing to its various advanced features such as great immunity to interferences, reliable privacy assurance, convenient management and excellent audio clarity.

Not stopping there, TAIDEN developed Interactive Recording and Webcasting Audio System dedicated to recording teacher's instruction and students' interaction in class by integrating digital infrared technology, DSP technology with array microphone. The system ensures broadcast level audio quality by picking up teachers' sound with IR microphone, and the sound can be separately routed to the classroom reinforcement system. A 360-degree array microphone is used to pick up students' interactive activities; the sound will be further processed by the "3A" algorithm (ANC, AEC, AGC) and then mixed with the teacher's audio to be fed into a third-party recording system. The Interactive Recording and Webcasting Audio System makes a perfect audio solution for class recording and reinforcement by offering crystal-clear reproduction class activities.

### System features

- High quality sound pickup for both the teacher and students, to make every classroom a professional studio
- Original dirATC - digital infrared wireless transmission and control technology
- Digital infrared microphone for the teacher:
  - ◆ Full channel frequency response: 50 Hz ~ 20 kHz
  - ◆ SNR:  $\geq 90$  dBA
  - ◆ Total harmonic distortion:  $\leq 0.05\%$
- Built-in array microphone for students:
  - ◆ Directivity:  $\pm 15^\circ$  Beam forming
  - ◆ Frequency response: 100 Hz ~ 10 kHz
  - ◆ SNR:  $\geq 65.5$  dBA
  - ◆ Total harmonic distortion:  $\leq 0.1\%$
  - ◆ Pickup range: 5 m radius with medium ambient noise  
8 m radius in a quiet environment
- High performance digital signal processor (DSP): automatic noise canceller (ANC), acoustic echo canceller (AEC) and automatic gain control (AGC)
- Advanced artificial intelligence (AI) technology to realize automatic sound direction detection
- The voice of the teacher and the students will be mixed before being fed into a recorder, the mixing ratio is adjustable to get the optimal sound balance between the teacher and students

- Student microphone can be muted or its transmission gain can be decreased to improve the teacher's audio clarity
- Selectable infrared carrier frequency for simultaneous use of two wireless microphones
- Optional charging station for wireless microphone
- Wired microphone with charging station for wireless microphone, which built-in electronic lock to safeguard the wireless microphone, scan the QR code with mobile phone to unlock, or through central control or network management system to unlock
- Built-in digital audio power amplifier for easy sound reinforcement
- 1 Line in (PC IN), 1 Line out (LINE), 1 audio recording output (REC)
- USB Link function:
  - ◆ Digital audio input/output:
    - Lossless recording of digital audio signals via USB
    - Lossless import of streaming audio into the system
  - ◆ Power point slide navigation on the teacher microphone (TES-560x series)
- Can be connected to a central control system for centralized management
- Highly integrated, and easy to install



Schematic diagram of classroom audio system

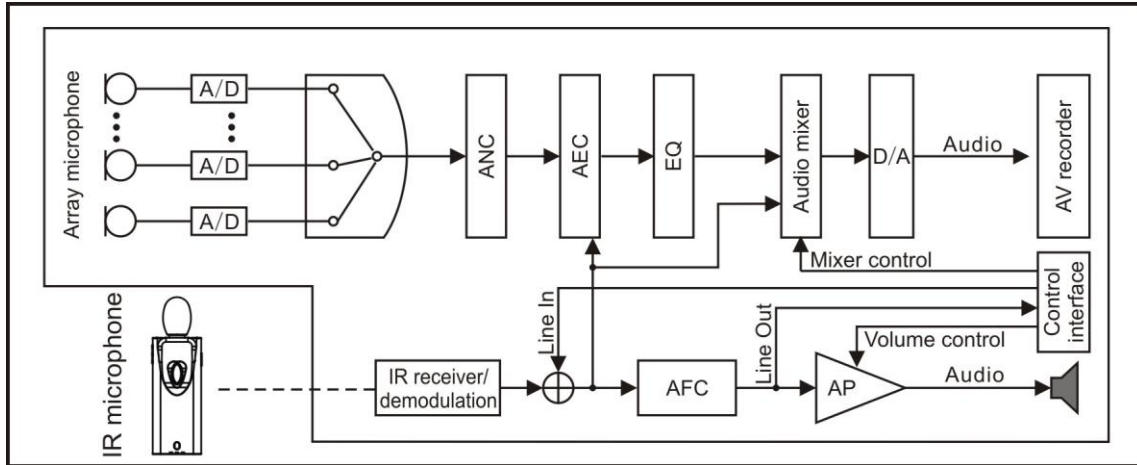

Products and functions list:

Function \ Type	TES-5680M + TES-5680BX	TES-5685MA
IR Mic	2	2
Array Mic.	•	•
Audio amplifier	•	•
Built-in speakers		•
ANC	•	•
AEC	•	•
AGC	•	•
PC IN/ LINE Out	•	• (with TES-5685BX)
MIC IN (TES-5600CSM Series)	•	• (with TES-5685BX)
REC.	•	•
Analog audio input/output		•
Digital audio input/output	•	
Power point slide	•	
Interface	RJ45	RJ45

**Note:**

ANC: Automatic Noise Canceller; AEC: Acoustic Echo Canceller; AGC: Automatic Gain Control



# TES-5606 Digital Infrared Wireless Microphone



## Functions

- Original dirATC—digital infrared audio transmission and control technology
- Infrared transmitting carrier frequency conforms to IEC 61603-7, DQPSK digital modulation/demodulation technology
- Insusceptible to interferences from HF-driven lighting and works perfectly in sunlight
- Supports audio input from external microphones (USB)
- Volume adjustment of the microphone
- Remote control of PPT slides
- Supports PTT (push to talk)
- Transmitter powers off automatically when no voice is detected for a preset period of time
- Microphone channel adjustable
- Ergonomically compact and elegant design, can be held in hand or hung around the neck via a nice strap or fit on the necktie
- Emission angle: vertical: 0°~ 90°, horizontal: 120°
- Emission range: linear transmitting distance: over 25 m
- Supports Lithium battery, battery life: 5 hours
- Charge via USB port (compatible with mobile phone charger)

## Controls and Indicators

- Microphone on/off button
- Microphone volume up/down button
- Microphone on (MIC) indicator
- PPT mode indicator
- Charging indicator
- “F” button: select MIC/PPT mode

## Interconnections

- USB port for charging

## Technical Specifications

### Electrical

IR transmission wavelength	870 nm
Modulation method	DQPSK
Power	DC 5 V, 2 A
Carrier frequency	Audio channel 1: 1.00 MHz Audio channel 2: 1.67 MHz Audio channel 3: 2.33 MHz Audio channel 4: 3.0 0MHz Audio channel 5: 3.67 MHz
Capacity of battery	1000 mAh
When mic. is continuously on	Approx. 5 hours

### Mechanical

Dimensions (h x w x d)	76 x 25 x 20 mm
Weight	40 g

## Ordering Information

TES-5606	Digital Infrared Wireless Microphone (built-in rechargeable lithium battery, excl. adapter, used with TES-5600NS_W neck lanyard or TES-5600CLP clip)
----------	--

## TES-1021 Clip Microphone



### Features

- Stylish and ergonomic design
- Used for TES-5604 series microphones
- Excellent immunity to RF interferences from mobile phones
- Ø 3.5 mm stereo plug with a 0.3-meter cable
- Color: black (PANTONE 419 C)
- Weight: 10 g

### Ordering Information

TES-1021.....Clip Microphone

## TES-1023 Head-worn Microphone



### Features

- Stylish and ergonomic design
- Used for TES-5604 series microphones
- Excellent immunity to RF interferences from mobile phones
- Ø 3.5 mm stereo plug with a 1-meter cable
- Weight: 18 g

### Ordering Information

TES-1023.....Head-worn Microphone

## TES-1022 Single-ear Microphone



### Features

- Stylish and ergonomic design
- Used for TES-5604 series microphones
- Excellent immunity to RF interferences from mobile phones
- Ø 3.5 mm stereo plug with a 0.55-meter cable
- Weight: 11 g

### Ordering Information

TES-1022.....Single-ear Microphone

**TES-5600MIC  
Wired Desktop Microphone**



**Features**

- Standard stem microphone
- 1 audio cable with USB port for connecting to main unit/ control box to transmit audio
- 1 microphone on/off button
- Dimensions (h x w x d, without stem): 43x135x132 mm
- Color: black (PANTONE 419 C)
- Weight: 0.5 kg

**Ordering Information**

TES-5600MIC.....Wired Desktop Microphone (standard stem microphone: 60cm, optional: 50/70cm)

**TES-5600CSMN  
Wired Desktop Microphone**



**Features**

- Standard stem microphone
- 1 audio cable with USB port for connecting to main unit/ control box to transmit audio
- 1 microphone on/off button
- 1 lockable charging station for one TES-5604 microphone
- Support connecting to central control system via RS232 for unlocking microphone
- Support network management for unlock microphone, microphone status display, setting classroom information
- 1 USB port for connecting to TES-ADP5V adapter
- Dimensions (h x w x d, without stem): 53x135x132 mm
- Color: black (PANTONE 419 C)
- Weight: 0.6 kg

**Ordering Information**

TES-5600CSMN.....Wired Desktop Microphone (standard stem microphone: 60cm, optional: 50/70cm; with a lockable charging station for one TES-5604 series microphone, can be unlocked via central control system or via network management system; support network management when used with TES-5604NSW Wireless Microphones Management Platform; with TES- ADP5V power adapter)

## TES-5600CSML Wired Desktop Microphone



### Features

- Standard stem microphone
- 1 audio cable with USB port for connecting to main unit/ control box to transmit audio
- 1 microphone on/off button
- 1 lockable charging station for one TES-5604 microphone
- Support connecting to central control system via RS232 for unlocking microphone
- Support unlocking via scanning QR code
- 1 USB port for connecting to TES-ADP5V adapter
- Dimensions (h x w x d, without stem): 53×135×132 mm
- Color: black (PANTONE 419 C)
- Weight: 0.6 kg

### Ordering Information

TES-5600CSML.....Wired Desktop Microphone (standard stem microphone: 60cm, optional: 50/70cm; with a lockable charging station for one TES-5604 series microphone, can be unlocked by scanning QR code or via central control system; with TES- ADP5V power adapter)

## TES-5600CSM Wired Desktop Microphone



### Features

- Standard stem microphone
- 1 audio cable with USB port for connecting to main unit/ control box to transmit audio
- 1 microphone on/off button
- 2 charging stations for TES-5604 microphones
- 1 USB port for connecting to TES-ADP5V adapter
- Dimensions (h x w x d, without stem): 53×135×132 mm
- Color: black (PANTONE 419 C)
- Weight: 0.6 kg

### Ordering Information

TES-5600CSM.....Wired Desktop Microphone (standard stem microphone: 60cm, optional: 50/70cm; with a charging station for two TES-5604 series microphones, with TES- ADP5V power adapter)



## MS50/60/70EGD2B Stem Microphone



---

### Features

- Built-in windshield
- With 2 flexible parts
- Used for TES-5600 series Wired Desktop Microphone
- Stem length: 50/60/70 cm
- Microphone
  - ◆ Type: Uni-directional electret condenser microphone
  - ◆ Sensitivity: -46 dBV/Pa
  - ◆ Frequency response: 75 Hz ~ 20 kHz
  - ◆ input resistance: 680 kΩ
  - ◆ Directivity 0°/180°: > 20 dB (1 kHz)
  - ◆ Equivalent noise: 20 dBA (SPL)
  - ◆ Maximum sound pressure level: 115 dB (THD < 3%)
- Color: black (PANTONE 419 C)
- Weight: MS50EGD2B (102 g)
  - MS60EGD2B (105 g)
  - MS70EGD2B (107 g)

---

### Ordering Information

MS50EGD2B.....	Stem Microphone (50 cm, built-in windshield, flexible gooseneck tube, for TES-5600 series Wired Desktop Microphone, black)
MS60EGD2B.....	Stem Microphone (60 cm, built-in windshield, flexible gooseneck tube, for TES-5600 series Wired Desktop Microphone, black)
MS70EGD2B.....	Stem Microphone (70 cm, built-in windshield, flexible gooseneck tube, for TES-5600 series Wired Desktop Microphone, black)

## TES-5680/30 Interactive Audio Recording System



TES-5680M



TES-5680BX

### System features

- Original dirATC-digital infrared Audio Transmitting and Control technologies
- Infrared transmitting carrier frequency conforms to IEC 61603-7, DQPSK digital modulation/demodulation technology
- World pioneering infrared technology enables excellent audio quality
- High quality sound pickup for both the teacher and students, to make every classroom a professional studio
- Digital infrared microphone for the teacher
- Built-in array microphone for students:
  - ◆ Directivity:  $\pm 15^\circ$  Beam forming
  - ◆ Frequency response: 100 Hz ~ 10 kHz
  - ◆ SNR:  $\geq 65.5$  dBA
  - ◆ Total harmonic distortion:  $\leq 0.1\%$
  - ◆ Pickup range: 5 m radius with medium ambient noise  
8 m radius in a quiet environment
- High performance digital signal processor (DSP): automatic noise canceller (ANC), acoustic echo canceller (AEC) and automatic gain control (AGC)
- The voice of the teacher and the students will be mixed before being fed into a recorder, the mixing ratio is adjustable to get the optimal sound balance between the teacher and students
- Student microphone can be muted or its transmission gain can be decreased to improve the teacher's audio clarity
- Selectable infrared carrier frequency for simultaneous use of two wireless microphones
- Built-in digital audio power amplifier for easy sound reinforcement
- 1 Line in (PC IN), 1 Line out (LINE), 1 audio recording output (REC)
- USB Link function:
  - ◆ Digital audio input/output:
    - Lossless recording of digital audio signals via USB
    - Lossless import of streaming audio into the system

- ◆ Remote PPT slide navigation with the TES-560x series microphone
- Can be connected to a central control system for centralized management
- Highly integrated, and easy to install

### Controls and Indicators

- 12-segment light indicator for accurate sound direction indication (TES-5680M)
- Switch:
  - ◆ AFC on: turn on AFC function
  - ◆ FREQ.: select IR frequency
  - ◆ AEC on: select communication mode, PC or Recorder
  - ◆ AUTO FADE: student microphone can be muted or its transmission gain can be decreased
- Power on/off switch
- Sound mixing ratio adjustment fader
- Microphone sensitivity adjustment knob
- Bass and Treble adjustment knob
- Volume control knob

### Interconnections

- Multiple audio in/out interfaces:
  - ◆  $\varnothing 6.4$  mm jack for balance line output
  - ◆  $\varnothing 3.5$  mm jack for recording output
  - ◆ 2 speaker ports
  - ◆  $\varnothing 3.5$  mm jack for PC IN
- RJ45 interface for connecting TES-5600RN/30 receiver
- RJ45 socket (RECEIVER) for connection to TES-5680M
- A type USB interface for connection to TES-5600MIC or TES-5600CSM series wired microphone
- DC 24 V power supply for TES-5680BX/30
- Micro USB interface for digital audio input/output
- RJ45 socket (ETHERNET) for connection to central control system

### Technical Specifications

#### Electrical

#### Infrared microphone (sound pickup for teacher)

Carrier frequency.....Audio channel 1: 2.33 MHz  
 Audio channel 2: 3.67 MHz

Modulation method.....DQPSK

Frequency response.....Main unit to main unit: 50 Hz~20 kHz  
 Mic. to main unit: 100 Hz~20 kHz

SNR.....Mic. to main unit:  $\geq 90$  dBA

THD.....Mic. to main unit:  $\leq 0.05\%$

Dynamic range.....Mic. to main unit:  $\geq 85$  dB

Emission angle.....vertical:  $150^\circ (\pm 75^\circ)$ , horizontal:  $360^\circ$

IR radiation range:

Line-of-sight distance.....25 m

Covered range.....80 to 100 m<sup>2</sup>

**Array microphone (sound pickup for students)**

Directivity.....±15° Beam forming  
 Frequency response.....100 Hz ~ 10 kHz  
 SNR.....≥65.5 dBA  
 Total harmonic distortion.....≤0.1%  
 Pickup range.....5 m radius with medium ambient noise  
 8 m radius in a quiet environment

**Other**

Mixed output level.....-20 dBV  
 Maximum output power of power amplifier.....60 W×2 (8 Ω)  
 30 W×4 (8 Ω)  
 Control box power supply.....DC 24 V  
 ETHERNET.....connection to central control system network

**Mechanical**

Dimension (mm).....∅ 181× 96 (TES-5680M/30)  
 h × w × d: 41×168×103 (TES-5680BX/30)  
 Weight.....0.4 kg (TES-5680M/30)  
 0.4 kg (TES-5680BX/30)

**Ordering Information**

TES-5680M/30.....Interactive Audio Recording System Receiver (with built-in array microphone, high performance DSP with ANC, AEC and AGC algorithm, with digital infrared receiver)  
 TES-5680BX/30.....Interactive Audio Recording System Control Box (supports 2 wireless microphones, 1 line in, 1 line out + 1 output for recording, digital audio input/output (micro USB), built-in audio power amplifier for connection to 4 loudspeakers, with TES-ADP24V adapter)

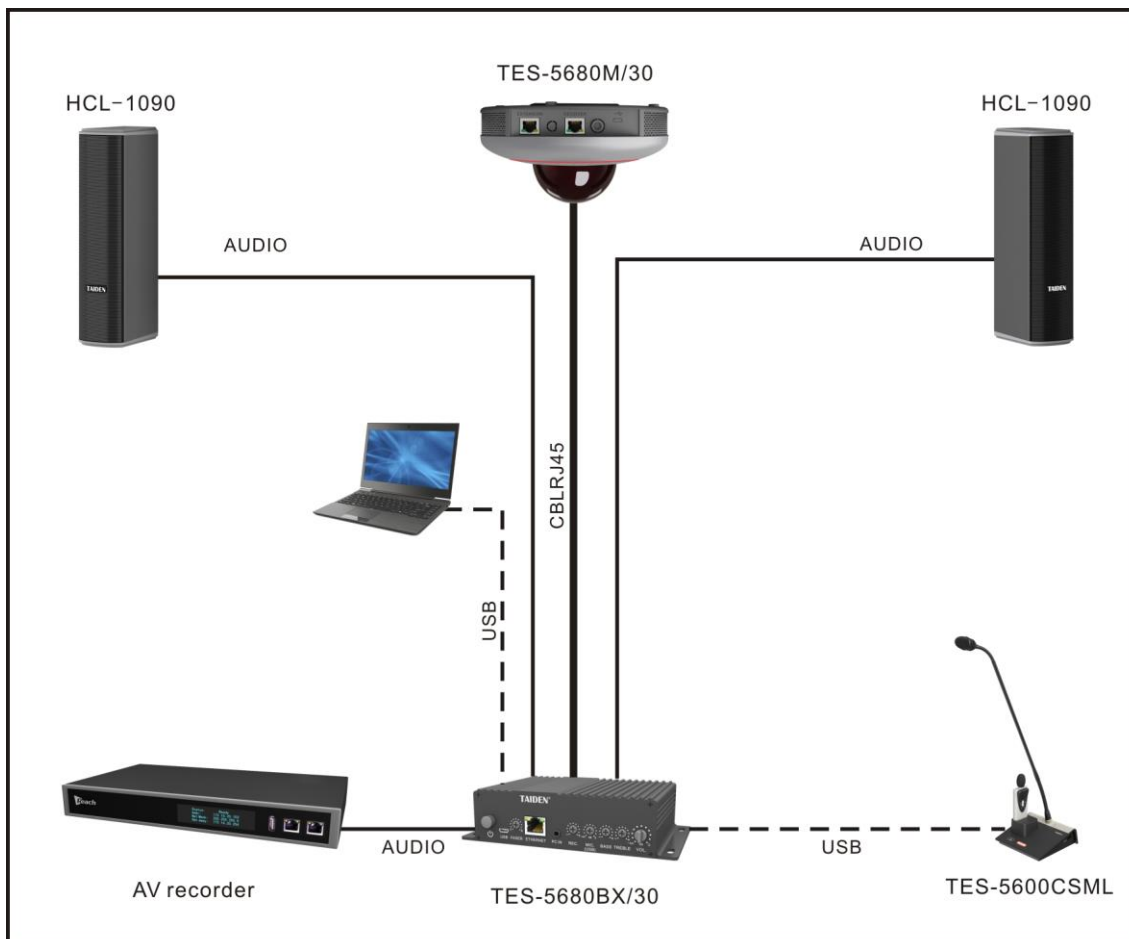

TES-5680 Interactive Audio Recording System Solution

# TES-5685MA-F/30 Interactive Audio Recording System



## System features

- Original dirATC-digital infrared Audio Transmitting and Control technologies
- Infrared transmitting carrier frequency conforms to IEC 61603-7, DQPSK digital modulation/demodulation technology
- World pioneering infrared technology enables excellent audio quality
- High quality sound pickup for both the teacher and students, to make every classroom a professional studio
- Digital infrared microphone for the teacher
- Built-in array microphone for students:
  - ◆ Directivity:  $\pm 15^\circ$  Beam forming
  - ◆ Frequency response: 100 Hz ~ 10 kHz
  - ◆ SNR:  $\geq 65.5$  dBA
  - ◆ Total harmonic distortion:  $\leq 0.1\%$
  - ◆ Pickup range: 5 m radius with medium ambient noise  
8 m radius in a quiet environment
- High performance digital signal processor (DSP): automatic noise canceller (ANC), acoustic echo canceller (AEC) and automatic gain control (AGC)
- The voice of the teacher and the students will be mixed before being fed into a recorder, the mixing ratio is adjustable to get the optimal sound balance between the teacher and students
- Student microphone can be muted or its transmission gain can be decreased to improve the teacher's audio clarity
- Selectable infrared carrier frequency for simultaneous use of two wireless microphones
- Built-in digital audio power amplifier for easy sound reinforcement
- Power point slide navigation on the teacher microphone (TES-560x series)
- Support analog audio input/output and recording output
- Can be connected to a central control system for centralized management
- Highly integrated, and easy to install

## Controls and Indicators

- 12-segment light indicator for accurate sound direction indication
- Switch:
  - ◆ F1: select IR frequency
  - ◆ F2: broadcast mode
  - ◆ AFC: set AFC function
  - ◆ AUTO FADE on: reduce line in volume automatically when the IR microphone is on
- Microphone sensitivity adjustment knob for USB interface
- Bass and Treble adjustment knob
- Sound mixing ratio adjustment fader
- Volume control knob

## Interconnections

- Multiple audio in/out interfaces:
  - ◆  $\varnothing$  3.5 mm jack for recording output
  - ◆  $\varnothing$  3.5 mm jack for PC IN
- RJ45 socket (RECEIVER) for connection to TES-5685BX series
- BNC interface for connecting to TES-5600R receiver

## Technical Specifications

### Electrical

#### Infrared microphone (sound pickup for teacher)

Carrier frequency	Audio channel 1: 1.67 MHz
	Audio channel 2: 2.33 MHz
	Audio channel 3: 3.0 MHz
Frequency response	Main unit to main unit: 50 Hz - 20 kHz
	Mic. to main unit: 100 Hz - 20 kHz
SNR	Mic. to main unit: $\geq 90$ dBA
THD	Mic. to main unit: $\leq 0.05\%$
Dynamic range	Mic. to main unit: $\geq 85$ dB
Wavelength	870 nm
Modulation method	DQPSK
Emission angle	vertical: $150^\circ (\pm 75^\circ)$ , horizontal: $360^\circ$
IR radiation range:	
Line-of-sight distance	25 m
Covered range	80 to 100 m <sup>2</sup>

#### Array microphone (sound pickup for students)

Directivity	$\pm 15^\circ$ Beam forming
Frequency response	100 Hz ~ 10 kHz
SNR	$\geq 65.5$ dBA
Total harmonic distortion	$\leq 0.1\%$
Pickup range	5 m radius with medium ambient noise 8 m radius in a quiet environment

### Other

Mixed output level	-20 dBV
Built-in speakers	4 $\Omega$ , 15 W
Control box power supply	AC 100-240 V, 1.5 A
LAN	connection to central control system network

**Mechanical**

Dimension (h x w x d mm).....206x332x319  
Weight.....3.5 kg  
Color.....White

---

**Ordering Information**

TES-5685MA-F/30.....Interactive Audio Recording System  
Main Unit (with built-in array  
microphone, high performance DSP  
with ANC, AEC and AGC algorithm,  
audio localization, with digital infrared  
receiver, supports 2 wireless  
microphones, with analog audio  
input/output, output for recording,  
built-in audio power amplifier and  
integrated loudspeakers, RJ45  
interface for extending receiver, Type  
F plug)

# TES-5685MA-B/30 Interactive Audio Recording System



## System features

- Original dirATC-digital infrared Audio Transmitting and Control technologies
- Infrared transmitting carrier frequency conforms to IEC 61603-7, DQPSK digital modulation/demodulation technology
- World pioneering infrared technology enables excellent audio quality
- High quality sound pickup for both the teacher and students, to make every classroom a professional studio
- Digital infrared microphone for the teacher
- Built-in array microphone for students:
  - ◆ Directivity:  $\pm 15^\circ$  Beam forming
  - ◆ Frequency response: 100 Hz ~ 10 kHz
  - ◆ SNR:  $\geq 65.5$  dBA
  - ◆ Total harmonic distortion:  $\leq 0.1\%$
  - ◆ Pickup range: 5 m radius with medium ambient noise  
8 m radius in a quiet environment
- High performance digital signal processor (DSP): automatic noise canceller (ANC), acoustic echo canceller (AEC) and automatic gain control (AGC)
- The voice of the teacher and the students will be mixed before being fed into a recorder, the mixing ratio is adjustable to get the optimal sound balance between the teacher and students
- Student microphone can be muted or its transmission gain can be decreased to improve the teacher's audio clarity
- Selectable infrared carrier frequency for simultaneous use of two wireless microphones
- Built-in digital audio power amplifier for easy sound reinforcement
- Power point slide navigation on the teacher microphone (TES-560x series)
- Support analog audio input/output and recording output
- Can be connected to a central control system for centralized management
- Highly integrated, and easy to install

## Controls and Indicators

- 12-segment light indicator for accurate sound direction indication
- Switch:
  - ◆ F1: select IR frequency
  - ◆ F2: broadcast mode
  - ◆ AFC: set AFC function
  - ◆ AUTO FADE on: reduce line in volume automatically when the IR microphone is on
- Microphone sensitivity adjustment knob for USB interface
- Bass and Treble adjustment knob
- Sound mixing ratio adjustment fader
- Volume control knob

## Interconnections

- Multiple audio in/out interfaces:
  - ◆  $\varnothing 3.5$  mm jack for recording output
  - ◆  $\varnothing 3.5$  mm jack for PC IN
- RJ45 socket (RECEIVER) for connection to TES-5685BX series
- BNC interface for connecting to TES-5600R receiver

## Technical Specifications

### Electrical

#### Infrared microphone (sound pickup for teacher)

Carrier frequency	Audio channel 1: 1.67 MHz
	Audio channel 2: 2.33 MHz
	Audio channel 3: 3.0 MHz
Frequency response	Main unit to main unit: 50 Hz - 20 kHz
	Mic. to main unit: 100 Hz - 20 kHz
SNR	Mic. to main unit: $\geq 90$ dBA
THD	Mic. to main unit: $\leq 0.05\%$
Dynamic range	Mic. to main unit: $\geq 85$ dB
Wavelength	870 nm
Modulation method	DQPSK
Emission angle	vertical: $150^\circ (\pm 75^\circ)$ , horizontal: $360^\circ$
IR radiation range:	
Line-of-sight distance	25 m
Covered range	80 to 100 m <sup>2</sup>

#### Array microphone (sound pickup for students)

Directivity	$\pm 15^\circ$ Beam forming
Frequency response	100 Hz ~ 10 kHz
SNR	$\geq 65.5$ dBA
Total harmonic distortion	$\leq 0.1\%$
Pickup range	5 m radius with medium ambient noise 8 m radius in a quiet environment

### Other

Mixed output level	-20 dBV
Built-in speakers	4 $\Omega$ , 15 W
Control box power supply	AC 100-240 V, 1.5 A
LAN	connection to central control system network

**Mechanical**

Dimension (h x w x d mm).....206x332x319  
Weight.....3.5 kg  
Color.....White

---

**Ordering Information**

TES-5685MA-B/30.....Interactive Audio Recording System  
Main Unit (with built-in array  
microphone, high performance DSP  
with ANC, AEC and AGC algorithm,  
audio localization, with digital infrared  
receiver, supports 2 wireless  
microphones, with analog audio  
input/output, output for recording,  
built-in audio power amplifier and  
integrated loudspeakers, RJ45  
interface for extending receiver, Type  
B plug)

## TES-5685BX/30 Function Extension Box



### Functions

- Function extension box for TES-5685M series
- 1 PC in and 1 line out
- Volume of MIC. IN and LINE IN adjustable
- 1 RJ45 interface for connecting to TES-5685M series to transmit audio
- Power supply: 5 V, 2 A from Micro USB
- Dimensions (h x w x d): 30 x 105 x 82 mm
- Weight: 0.2 kg

### Ordering Information

TES-5685BX/30.....Function Extension Box (for TES-5685M series, analog audio input/output, can connect to TES-5600 series Wired Desktop Microphone for audio transmission, 1 line out+1 line in)

## TES-5685BXP/30 Function Extension Box



### Functions

- Function extension box for TES-5685M
- 1 PC in and 1 line out
- 1 input for public address system, when the PA trigger enabled, the audio of PA IN puts out to all outputs and all other inputs are muted
- Volume of MIC. IN and LINE IN adjustable
- 1 RJ45 interface for connecting to 5685M to transmit audio
- Power supply: 5 V, 2 A (Micro USB)
- Dimensions (h x w x d): 30 x 105 x 82 mm
- Weight: 0.2 kg

### Ordering Information

TES-5685BXP/30.....Function Extension Box (for TES-5685M series, analog audio input/output, can connect to TES-5600 series Wired Desktop Microphone for audio transmission, 1 line out+1 line in, 1 PA in + 1 PA trigger)



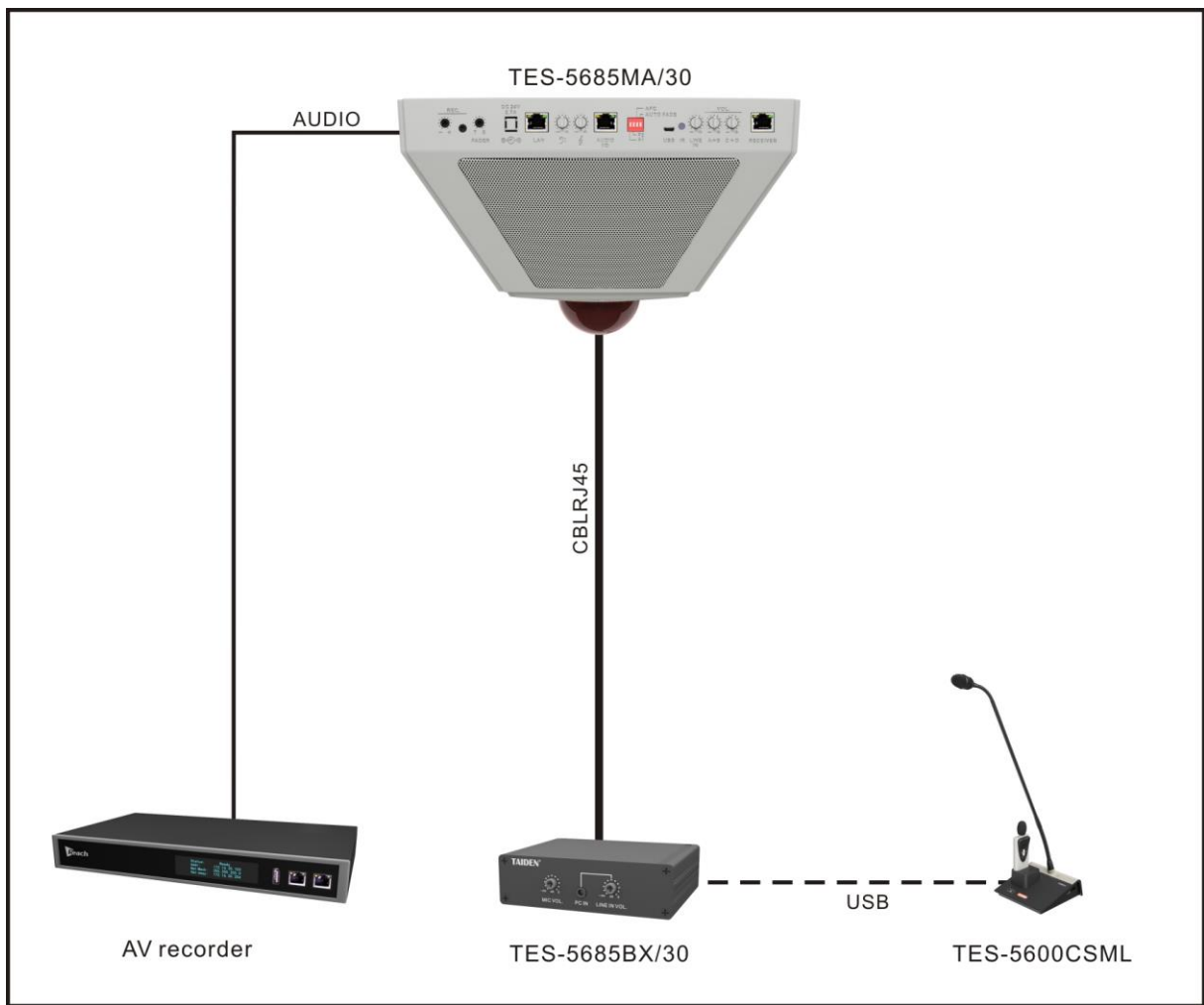

TES-5685MA Interactive Audio Recording System Solution